

Ponzio  
oan  
nel  
i

È un'emozione nuova.

Sentirla palpitare  
è come riconoscere  
l'essenziale.

Toccarla con mano,  
è come raggiungere  
la perfezione.

La vivi, sorridi,  
ti piace, poi ferma  
...sussurra:

“Bentornati a casa”.

PLANA  
IL PORTONCINO ESSENZIALE



## INDICE | INDEX

L'Azienda   The Company	pag. 8
Made in Ponzio   Made in Ponzio	pag. 10
Le prestazioni   Performances	pag. 12
La stratificazione dei pannelli   Panels stratification	pag. 14
Inserti in alluminio   Aluminum inserts	pag. 15
I colori per la tua casa   The colours for your home	pag. 16
I portoncini   Aluminium doors	pag. 20
Riepilogo modelli   Models summary	pag. 70
Listino pannelli   Panels price list	pag. 76
Listino accessori   Accessories price list	pag. 78
Cartella colori   Colours folder	pag. 84



**Ponzio**  
pan  
nel  
li

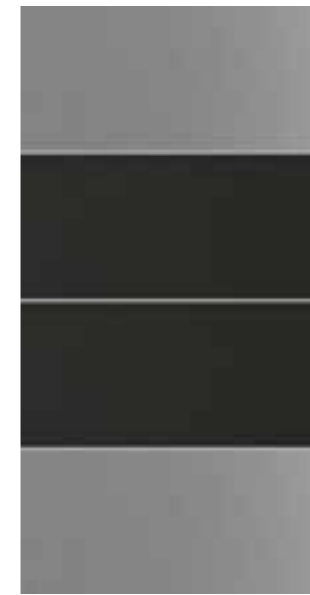
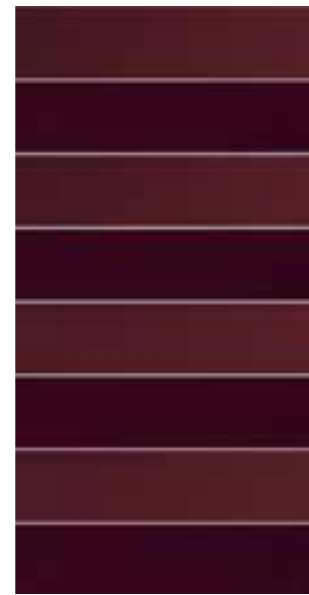
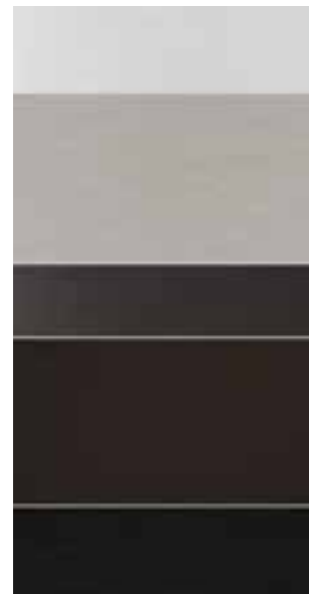
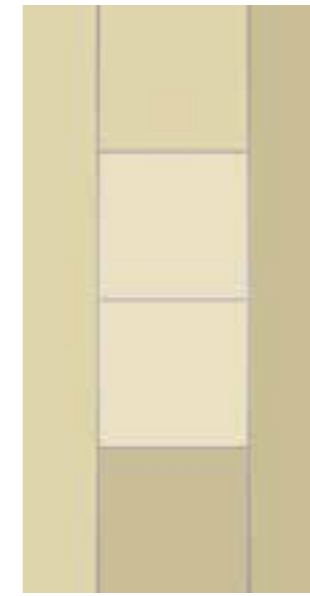
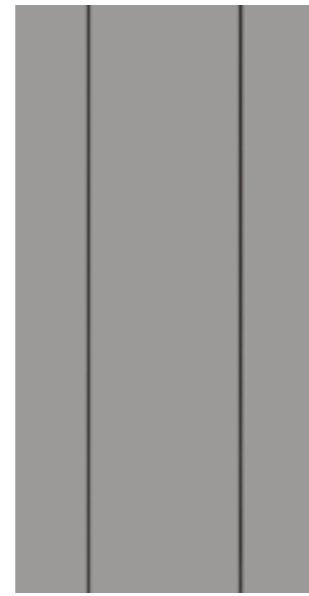

PLANA  
IL PORTONCINO ESSENZIALE

SCOPRI LE NOVITÀ

L'arma vincente per ottenere grandi risultati è essere precursori dei tempi: i portoncini Ponzio Pannelli ne sono la prova. Precursore ed innovatore dei pannelli in alluminio, il marchio Plana apre le porte alla nuova stagione della casa con le esclusive novità dei portoncini d'ingresso che rendono il brand importante riferimento di stile e tendenze.

DISCOVER THE NEWS

The winning weapon to get great results is to be precursors of the times: Ponzio Doors are the proof. Precursor and innovator of aluminum panels market, the brand Plana opens the doors to the new home season with unique innovations of the doors that make the brand more and more a reference of style and trends.

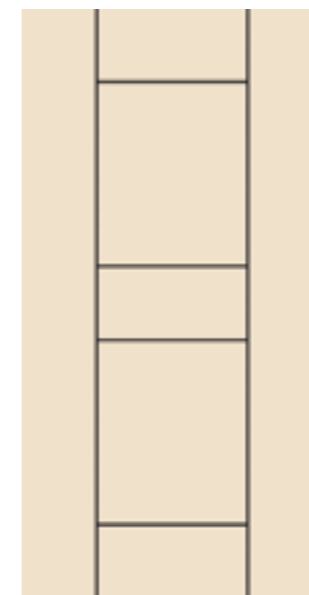
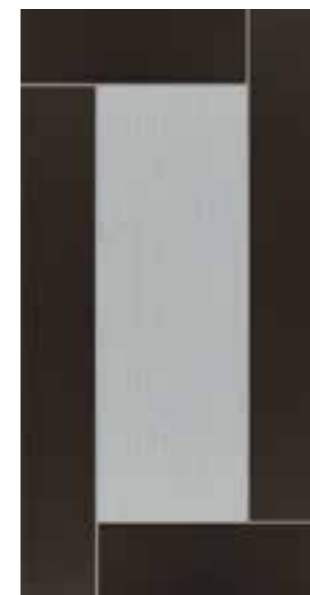
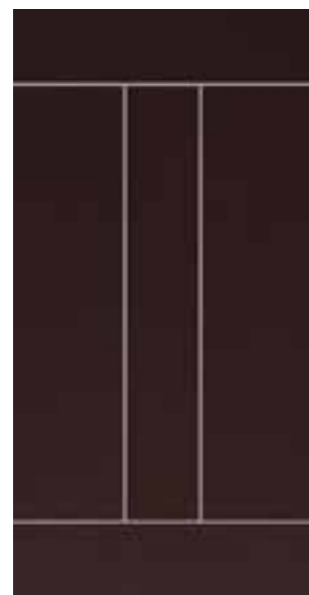



## L'AZIENDA

Ponzio è un'azienda leader da oltre 70 anni nella produzione e progettazione di sistemi in alluminio ad alta efficienza energetica per l'architettura contemporanea, con particolare attenzione alle finiture superficiali, di cui offre un'ampia gamma tecnologicamente avanzata.

Prestazioni impeccabili, design esclusivo e altissima affidabilità dei suoi prodotti - facciate, finestre, porte e sistemi frame less - fanno di Ponzio un partner di riferimento capace di soddisfare appieno le esigenze sia del progettista che del cliente. Tutto sostenuto da costanti investimenti in ricerca, tecnologia, innovazione e creatività: per ottenere risultati eccellenti e mantenere posizioni di leadership nel mercato. Nell'ultimo decennio, inoltre, è cresciuta molto anche la dimensione internazionale dell'azienda, con l'apertura di nuovi mercati come quello asiatico, sudamericano, africano e nordeuropeo. La costante attenzione di Ponzio verso la qualità, l'ambiente e la sicurezza, ha portato l'azienda ad associarsi al GBC Italia che persegue lo sviluppo e l'adattamento del marchio LEED alla realtà italiana.

 **Ponzio**  
Aluminium design since 1941



## THE COMPANY

For more than 70 years Ponzio has been a market leader in the production and design of high-energy-efficiency aluminium systems for contemporary architecture (curtain wall, doors and frame less systems).

Ponzio offers a wide range of high quality surface finishes with particular attention to technologically advanced products. The company constantly invests in research, technology, innovation and creativity to attain excellence and maintain its leadership in the market. Moreover, in the last ten years the company has grown internationally by conquering new markets including Northern Europe, Africa, South America and Asia. The constant attention of Ponzio to quality, the environment and safety have led Ponzio to become a member of GBC Italy which pursues the development and adaptation of the LEED trademark in Italy.

## I PORTONCINI “LAVORATI” IN CASA: DALLA PROGETTAZIONE ALLA PRODUZIONE

**Made in Ponzio:** è questo il grande valore dei portoncini d'ingresso Plana, progettati e prodotti direttamente a “casa” Ponzio.

Nel 1941, da un'intuizione di Giuseppe Ponzio, nasce l'azienda omonima specializzata nel trattamento superficiale dell'alluminio. In questi oltre 70 anni di attività, Ponzio si è conquistata a ragione il titolo di leader assoluta nella progettazione, produzione e innovazione dei sistemi in alluminio per l'architettura con una filosofia aziendale orientata alla ricerca tecnologica, all'innovazione e alla fornitura del servizio, oltre che del prodotto. I portoncini Plana sono frutto di esperienza e capacità ma anche di studio continuo, oltre che di lungimiranti piani di investimento. È nato così lo stabilimento di produzione Plana, fiore all'occhiello del quartier generale Ponzio: oltre 60mila metri quadrati coperti nella zona industriale di Pineto.

## THE “HOMEMADE” DOORS: FROM DESIGN TO MANUFACTURING

**Made in Ponzio:** this is the great value of the entry Plana doors, directly designed and produced at Ponzio “home”.

In 1941 Giuseppe Ponzio founded the eponymous company specializing in the surface treatment of aluminum. In these 70 years of activity, Ponzio has earned the title of the absolute leader in the design, manufacture and innovation of aluminum systems for architecture with a corporate philosophy oriented to technological research, innovation and service, over that of the product. The doors Plana are the result of experience and ability but also of ongoing study, as well as forward-looking investment plans. So it is born the factory of Plana in the Ponzio headquarters: over 60 thousand square meters covered in the industrial area of Pineto.



Certificate of Excellence  
Certificato di Eccellenza  
N° 261



## H.I.+: IL PRIMO PANNELLO CON DOPPIA ANIMA

Plana è la materializzazione del concetto di innovazione nel mondo dei portoncini d'ingresso: il primo pannello con doppia anima flessibile (versione da 40 mm). Il massimo delle prestazioni: è questo il must che rende Plana unico nel suo genere. Da oggi, infatti, con la nuova tecnologia e l'inserimento della doppia anima flessibile, oltre a migliorare incredibilmente le prestazioni, questo prodotto innovativo sul mercato consente di controllare la dilatazione termica derivante dall'irraggiamento nella parte esterna. Inoltre, grazie all'inserimento della seconda anima flessibile, permette di controllare la dilatazione interna dovuta alla forte escursione termica tra la temperatura interna (ambiente riscaldato) e la temperatura esterna, soprattutto nei periodi invernali e in zone con forte escursione tra giorno e notte.

## H.I.+: THE FIRST DOUBLE CORE PANEL

Plana shows the materialization of the innovation concept in the front-door market. It represents the first double core panel (40 mm thickness) which just gets the best performances: this is the 'MUST' that makes Plana unique on its kind. Its new technology and its flexible double core enhance its own performances and allows a better control of the thermal expansion due to the sunlight irradiation of its outward side. Furthermore, the inward side expansion, due to the thermal difference between outside and inside temperature, mainly during winter time and in particular areas with high day-night temperature excursion, can be controlled thanks to the second flexible core.

## GAMMA IN T.H.F.

La composizione del pannello Plana fa un salto in avanti e presenta un nuovo materiale, il T.H.F. in fibra naturale. Un incredibile risultato di studi e implementazioni tecnologiche che oltre a migliorare i materiali del portoncino Plana, garantisce la massima lavorabilità del prodotto, planarità delle superfici ed incredibile resistenza ed elasticità. Inoltre la composizione in multistrati permette il fissaggio degli accessori in ogni punto del pannello.

## T.H.F. PANEL

Plana's panel composition steps forward and introduces a new material: the natural fiber T.H.F. It represents an outstanding outcome of research and technologic implementations that improves the composition of the Plana doors and guarantees the maximum product workability, the surface planarity and an exceptional strength and flexibility.

Moreover the multilayer panel composition grants the full surface availability for accessories installation.

LEGENDA | LEGEND

- 1 Poliuretano isolante HD  
Polyurethane non-conducting HD
- 2 H.I. anima flessibile  
Flexible core H.I.
- 3 Lamiera in alluminio 0,4 mm  
Aluminum sheet 0,4 mm
- 4 T.H.S. fibra naturale  
T.H.S. natural fibre
- 5 Lamiera in alluminio 1,2 mm  
Aluminum sheet 1,2 mm
- 6 Lamiera in alluminio 1,2 mm  
Aluminum sheet 1,2 mm
- 7 T.H.S. fibra naturale  
T.H.S. natural fibre
- 8 Lamiera in alluminio 0,4 mm  
Aluminum sheet 0,4 mm

### IL PANNELLO DALLE GRANDI PRESTAZIONI

- maggiore controllo della dilatazione termica derivante dall'irraggiamento nella parte esterna;
- maggiore controllo della dilatazione interna dovuto alla forte escursione termica tra la temperatura interna ed esterna nei periodi invernali e in zone con forte escursione tra giorno e notte;
- prestazioni superiori.

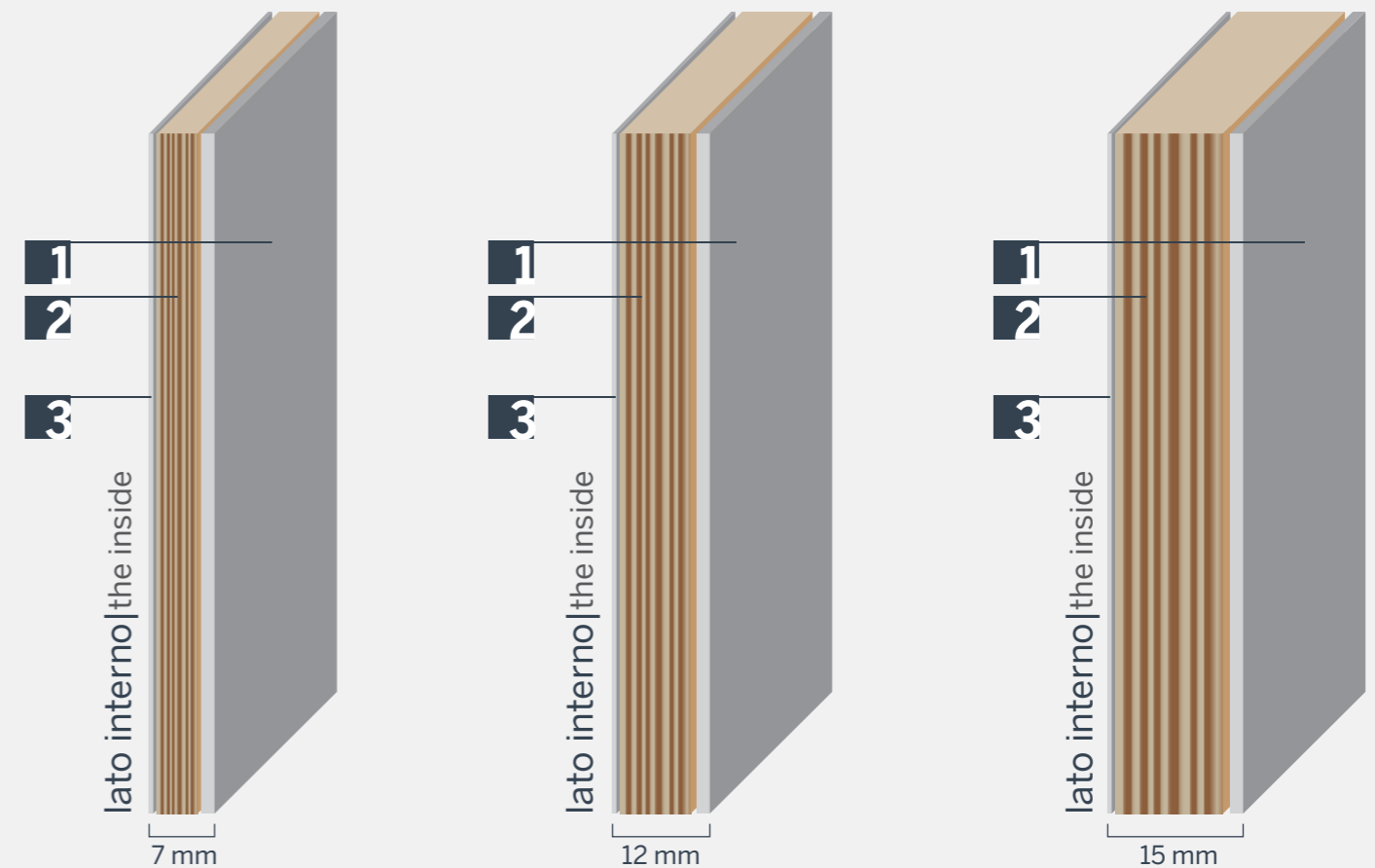
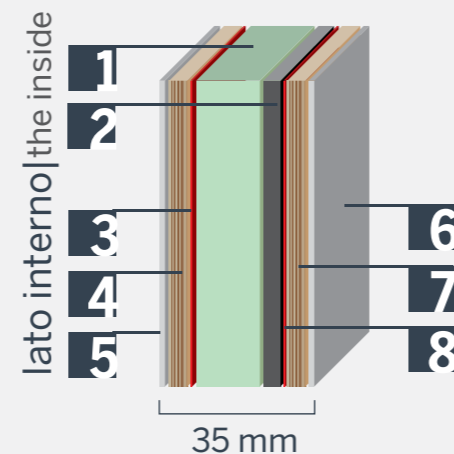
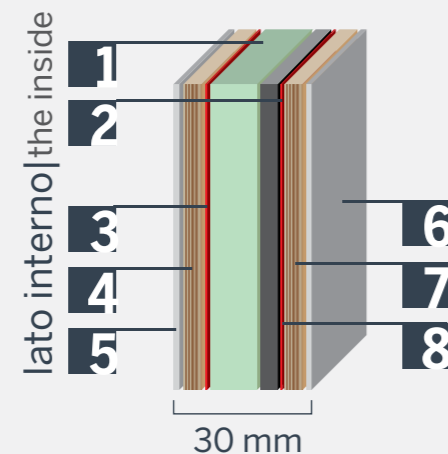
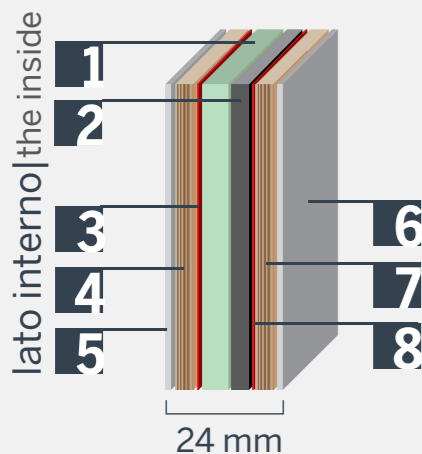
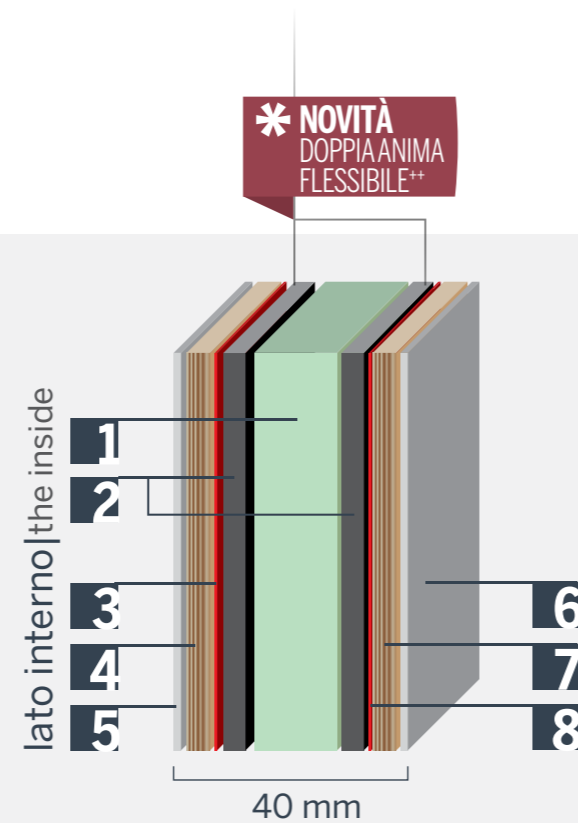

LEGENDA | LEGEND

- 1 Lamiera in alluminio 0,4 mm  
Aluminum sheet 0,4 mm
- 2 T.H.S. fibra naturale  
T.H.S. natural fibre
- 3 Lamiera in alluminio 1,2 mm  
Aluminum sheet 1,2 mm



SPESORE (mm)  
THICKNESS (mm)

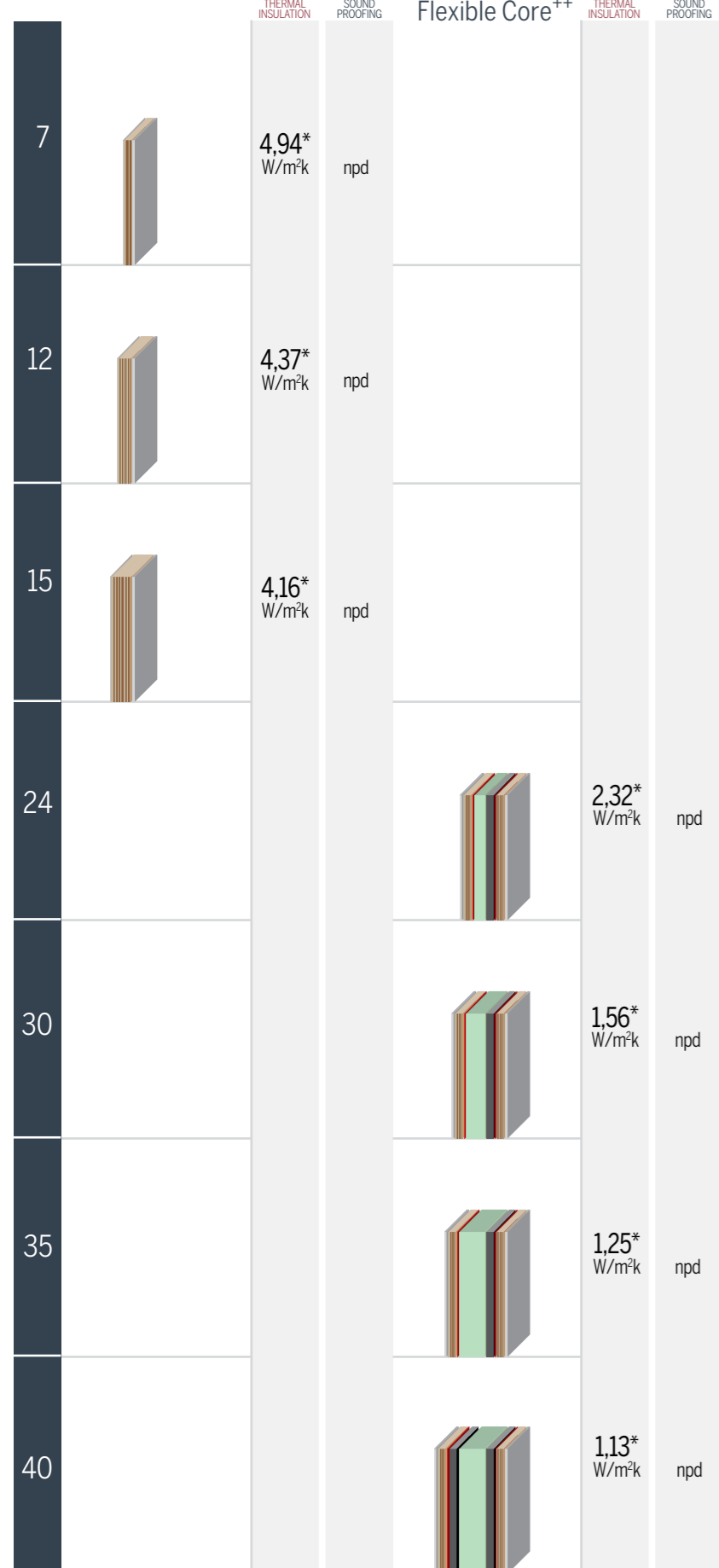

MISURE PANNELLI  
SIZE PANELS

<b>STANDARD STANDARD</b>	cm 100x220
<b>FUORI MISURA OVERSIZE</b>	cm MAX 115x245

TABELLA PESI\*  
WEIGHT TABLE\*

(riferito al pannello cieco)  
(only for blind panel)

SPESORE THICKNESS	COMPOSIZIONE COMPOSITION	PESO WEIGHT
7 mm	T.H.S.	9,60 Kg/m <sup>2</sup>
12 mm	T.H.S.	12,60 Kg/m <sup>2</sup>
15 mm	T.H.S.	15,80 Kg/m <sup>2</sup>
24 mm	H.I.**	23,50 Kg/m <sup>2</sup>
30 mm	H.I.**	25,50 Kg/m <sup>2</sup>
35 mm	H.I.**	26,50 Kg/m <sup>2</sup>
40 mm	H.I.**	27,50 Kg/m <sup>2</sup>

\*Valori provvisori  
\*Temporary values

## INSERTI IN ALLUMINIO: IL CUORE DELLA COLLEZIONE

Come Plana nessuno mai. Potrebbe essere questo lo spot per sintetizzare l'unicità della collezione del programma Ponzio Pannelli, che oltre alla doppia anima, hanno un cuore grande. Grande come l'impegno del team di lavoro a studiare e trovare il sistema per poter connettere diverse lamiera fra loro, mantenendo la perfetta planarità della superficie esterna e valorizzando il tutto con un inserto in alluminio. Solo noi, in esclusiva per il portoncino Plana, abbiamo creato uno speciale profilo in alluminio estruso. Ne è nato anche un brevetto di invenzione che tutela questo innovativo sistema di unione lamiera/profilo.

E non ci siamo fermati qui: chi sceglie Plana avrà la possibilità di personalizzare al massimo la propria porta e di scegliere anche il tipo di inserto a vista se 10 o 2 mm e la relativa finitura.

## ALLUMINIUM INSERTS: THE COLLECTION'S HEART

Nothing as PLANA has never seen before. It might be the commercial advertising launching the Ponzio Pannelli's collection program that, apart from the double core, put its great Heart into work. Great as the strengths of the Ponzio team focusing on the research of the best solutions that allows the connection between the panels, keeping the perfect planarity of the outside panel, enhanced with a special aluminum insert developed and patented for PLANA.

That's not all: Plana can be highly customized by choosing from the range of the aluminum insert decoration (from 10 to 2 mm thickness) and the several coatings.

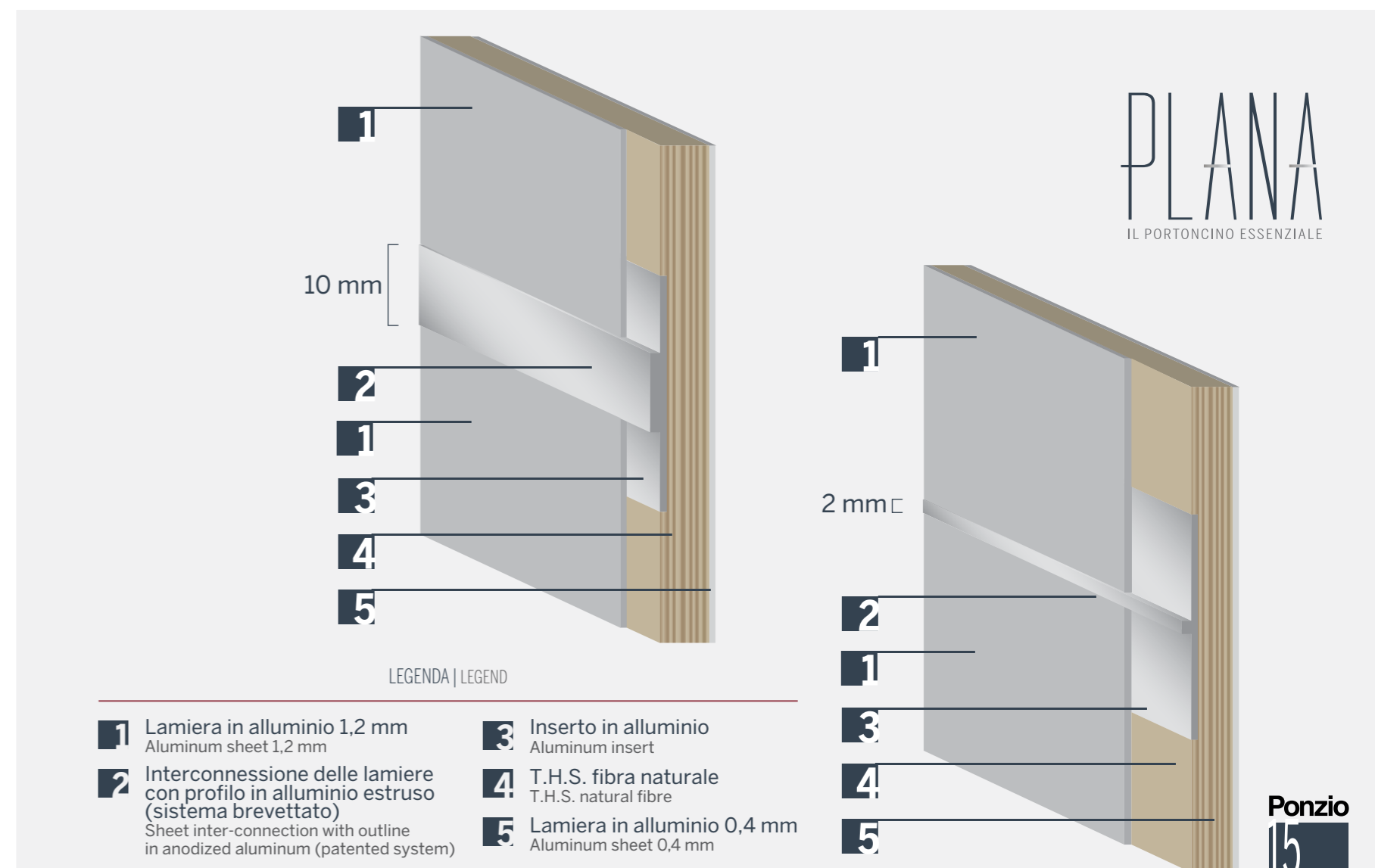

## I COLORI PER LA TUA CASA: UN'ESCLUSIVA PONZIO

Starox, Brased, Uberall sono le finiture superficiali del futuro che segnano un punto di svolta nel processo di colorazione dell'alluminio. Starox è la finitura dell'alluminio anodizzato colorato nelle due varianti di lucido e opaco, Brased è l'anodizzato graffiato, colorato. Le lavorazioni Uberall sanciscono poi la leadership di Ponzio in know-how e tecnologia. I nuovi impianti di verniciatura verticale e orizzontale con cambio colore rapido imprimono una gamma di colori brillanti e lucidi all'alluminio per un effetto finale mai visto prima. Le finiture Ponzio sono la risposta più efficace al desiderio di raffinata eleganza in casa.

## THE COLOURS FOR YOUR HOME: A PONZIO EXCLUSIVE

Starox, Brased, Uberall are the finished surfaces of the future which mark a turning point in the aluminum colouring process. Starox is the new finish for coloured, anodised aluminum and is available in bright or matt. Brased is anodised, scratched, coloured. Uberall treatment are the demonstrations of Ponzio's expertise in know-how and technology. The new vertical and horizontal painting machines can rapidly be changed from one colour to another giving a wide range of bright colours to the aluminium, allowing a colour quality never seen before. The Ponzio finished surfaces are the most effective reply to the desire of refined elegance at home.



Tutti i colori sono disponibili su [www.ponziocolorbox.it](http://www.ponziocolorbox.it)  
All finishes are available on [www.ponziocolorbox.it](http://www.ponziocolorbox.it)

**BRASED**<sup>®</sup>  
Anodizzato graffiato

**STAROX**  
Anodizzato lucido

**Velvet**  
Anodizzato vellutato

**Polycrom**<sup>®</sup>  
Ossidato spazzolato/Verniciato particolare

**Polycrom**<sup>®</sup>  
Ossidato spazzolato/Verniciato particolare

**Marbel**<sup>®</sup>  
Verniciato speciale garantito

**Uberall**<sup>®</sup>  
Sublimato effetto legno

**UberallHD**  
Sublimato effetto legno garantito

**VERTEX**<sup>®</sup>  
Sublimato effetti particolari

**Ral**  
Verniciato lucido e opaco





## Apri al portoncino essenziale: entra in Plana.

Plana è il portoncino che guarda all'essenziale. Nuovo nelle linee planari e geometriche, ricercato nelle finiture, un'esclusiva Ponzio, il portoncino è rigoroso nelle forme che si ispirano ad un design pulito e minimale. Plana è la sintesi di ricerca e tecnologia.

PLANA  
IL PORTONCINO ESSENZIALE

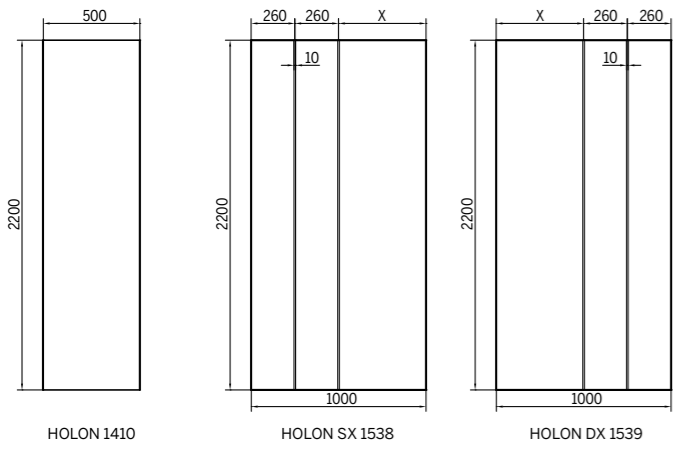

UBERALL Noce 41 UBNC41 / BRASED Specchio BDSH11  
Inseriti: Inox Bond

HOLON SX 1538

Maniglione BU890024  
NOA  
Cromo Satinato



Maniglione BU3608  
FASHION  
Acciaio Inox AISI 316L



UBERALL Renolit 21 UBRN21 / RAL 9010  
Inseriti: Inox Bond 52 STIB52

HOLON 1538



VELVET Grigio Fumo VEGFNR  
Inseriti: Inox Bond 52 STIB52

HOLON 1538

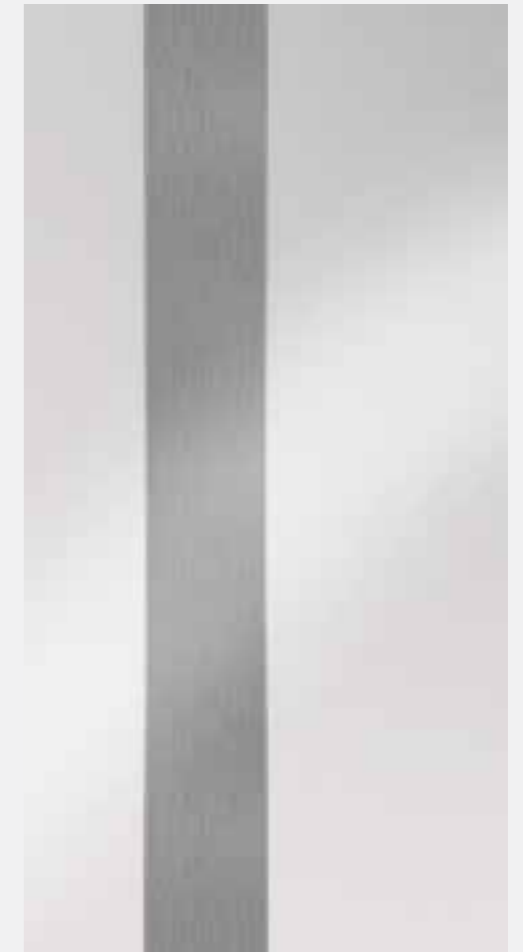

STAROX Silver 51 STSI51 / BRASED Specchio BDSH11  
Inseriti: Inox Bond 52 STIB52

HOLON 1538

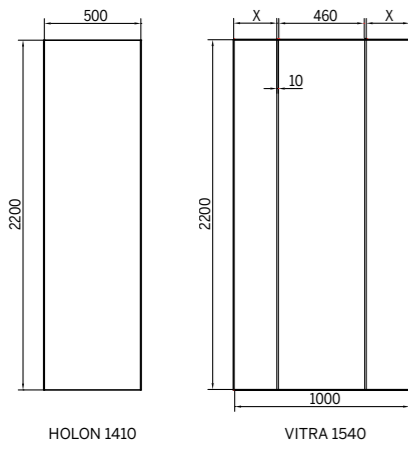

HOLON 1410

VITRA 1540



POLYCROM Argento Spazzolato OXAR / Anodizzato Argento OXVUNC  
Inseri: Inox Bond 52 STIB52

VITRA 1540

Maniglione BU3639  
SNOW 300  
Starox

Maniglione BU3578  
BIRICHINO  
Acciaio Inox AISI 316L



PLANA  
IL PORTONCINO ESSENZIALE



VELVET Artic AVEATNR  
BRASED ULTRA Grigio Tungsteno BDTG11  
Inseri: Inox Bond 52 STIB52

VITRA 1540

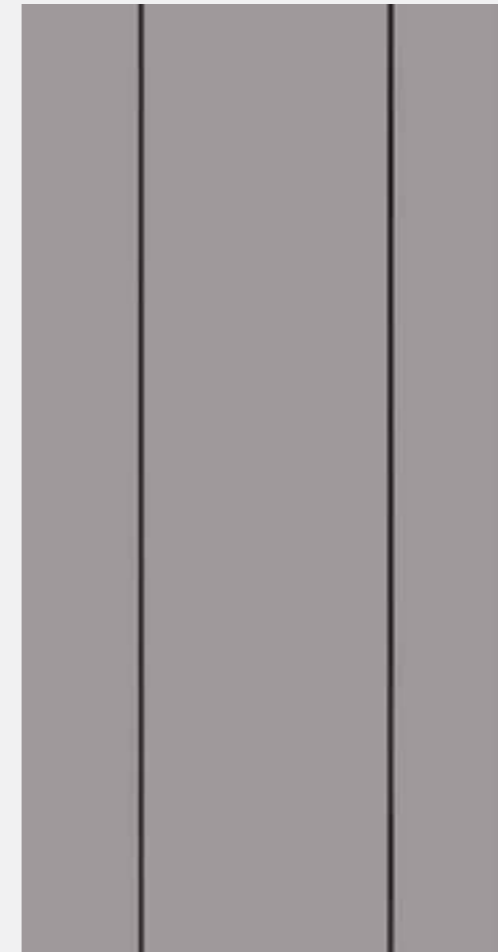

Ral 9006  
Inseri: Grigio Tungsteno BDTG11

VITRA 1540



POLICROM Grigio Polvere M7000  
Inseri: Inox Bond 52 STIB52

VITRA 1540

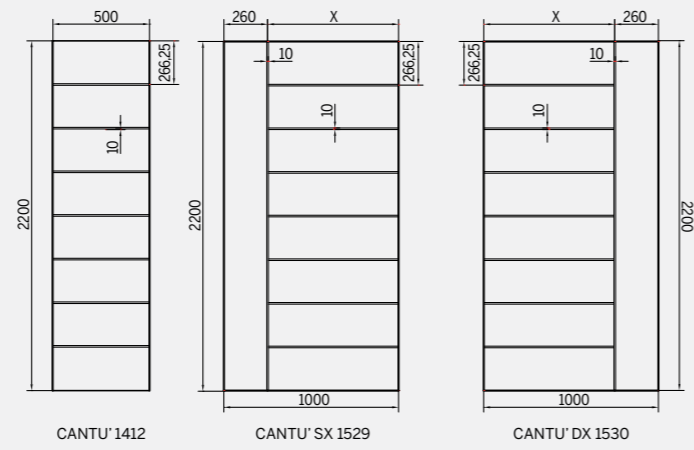

RAL 9010 / UBERALL Wengè UBWE11  
Inseri: Inox Bond 52 STIB52

CANTU' 1529



STAROX Rosso Passion 51 STRP51  
BRASED Amaranto BDAM11  
Inseri: Inox Bond 52 STIB52

CANTU' 1529

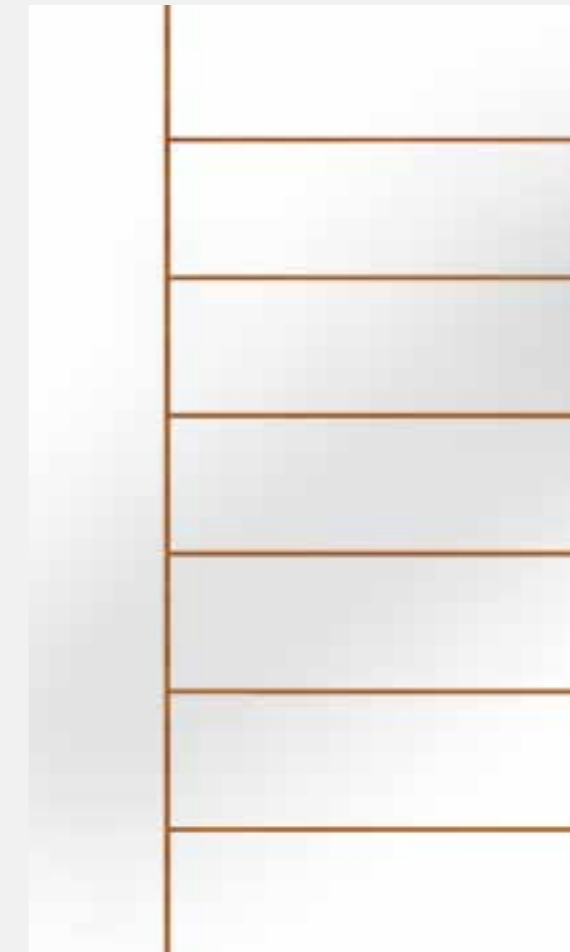

RAL 9010  
Inseri: Ciliegio 42 UBCI42

CANTU' 1529

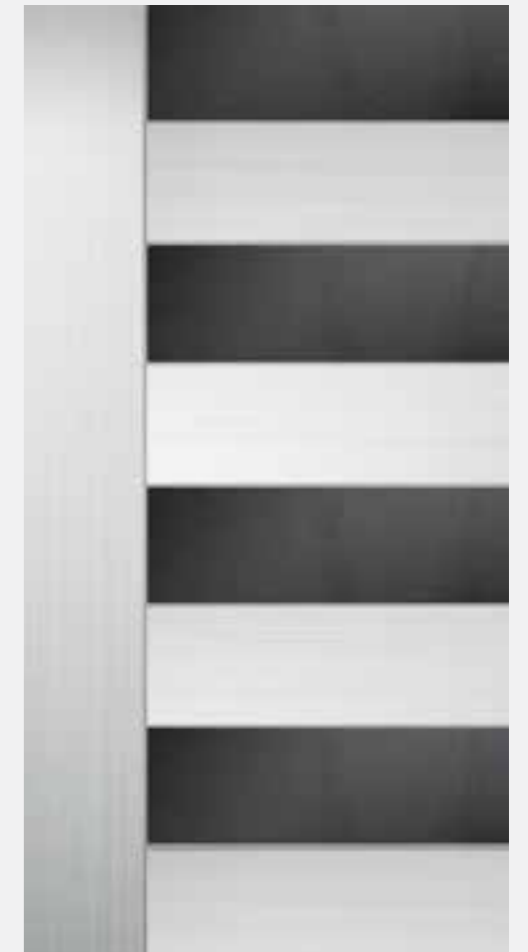

POLICROM Grigio Polvere M7000  
Argento Spazzolato OXAR  
Inseri: Inox Bond 52 STIB52

CANTU' 1529

Maniglione BU890044  
WAVE  
Cromo Satinato



Maniglione BU3738  
LUXURY  
Acciaio Inox  
AISI 316L



PLANA  
IL PORTONCINO ESSENZIALE

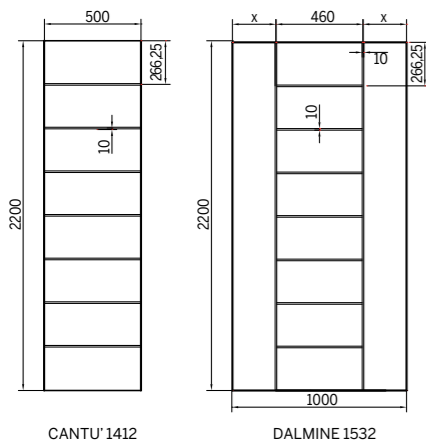

CANTU' 1412

DALMINE 1532

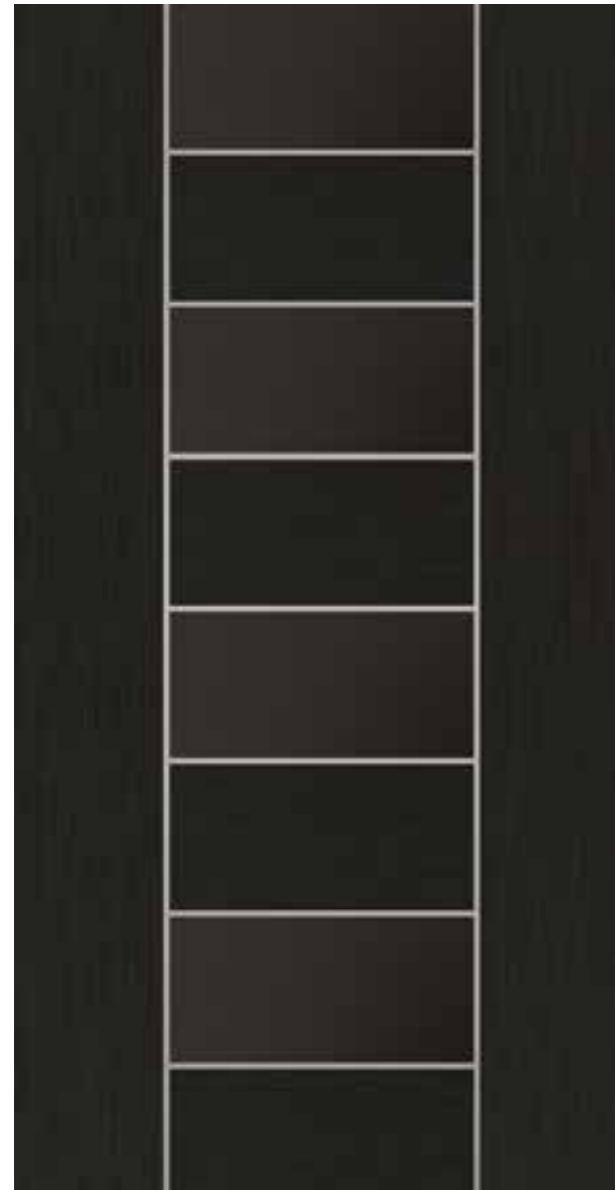

BRASED Grigio Tungsteno BDTG11 / STAROX Grigio Fly 51 STGF51  
Inseriti: Inox Bond 52 STIB52

DALMINE 1532

Maniglione BU890034  
QUADROZEN  
Cromo Satinato



Maniglione BU3549  
WARM 400  
Starox



PLANA  
IL PORTONCINO ESSENZIALE



UBERALL Douglas 31 UBDU31  
UBERALL HDROvere 25 USRV25  
Inseriti: Inox Bond 52 STIB52

DALMINE 1532

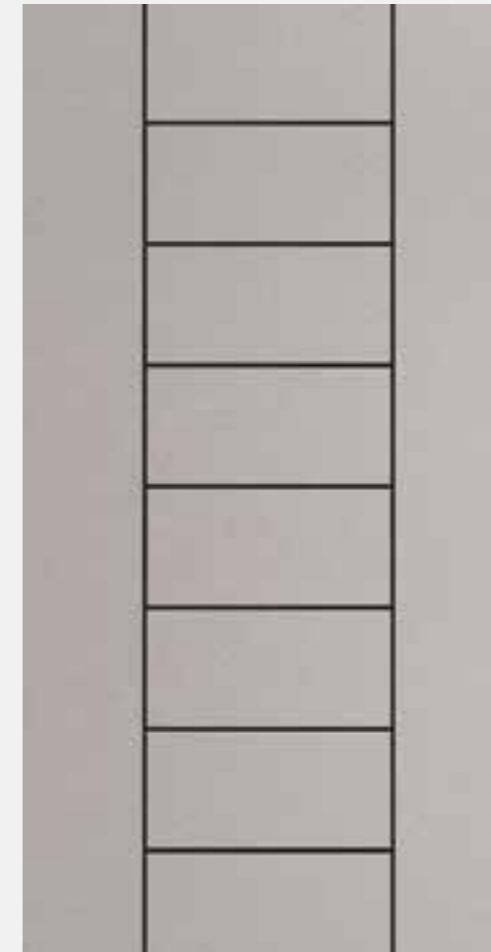

STAROX Inox Bond 52 STIB52  
Inseriti: Grigio Tungsteno BDTG11

DALMINE 1532

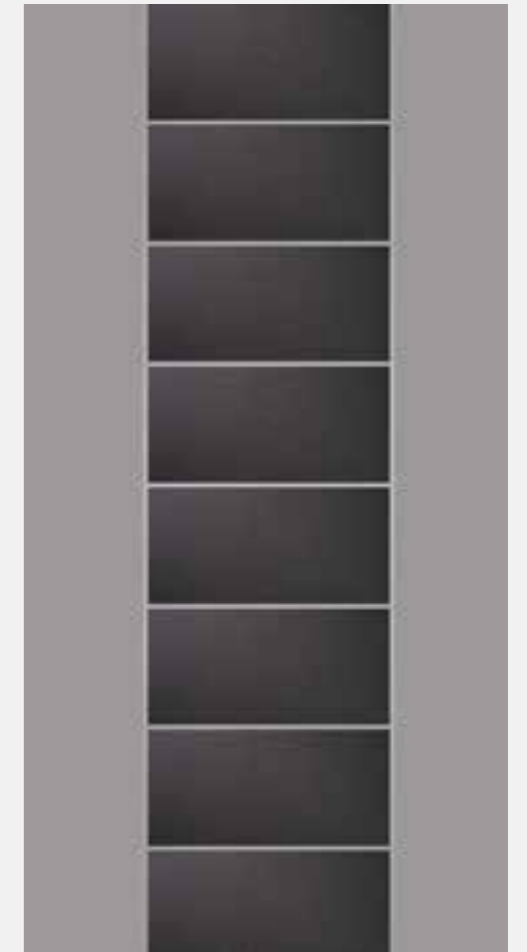

RAL 9006 / POLICROM Ferro Micacero FEMIC  
Inseriti: Inox Bond 52 STIB52

DALMINE 1532



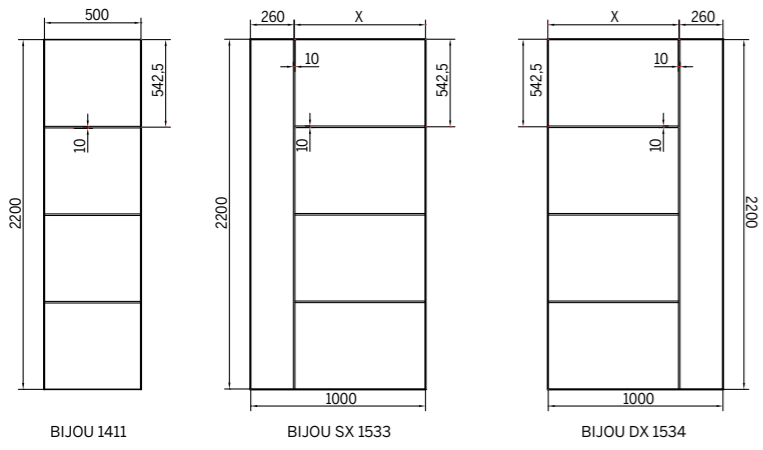

RAL 9010 / STAROX Inox Bond 52 STIB52  
Inseriti: Inox Bond 52 STIB52

BIJOU 1533

Maniglione BU3468  
RAIN 600  
Acciaio Inox



Maniglione BU3678  
MAGNETIC  
Acciaio Inox AISI 316L



PLANA  
IL PORTONCINO ESSENZIALE



POLICROM Marrone Corten CROMAR  
BRASED Specchio BDSH11  
Inseriti: Inox Bond 52 STIB52

BIJOU 1533



UBERALL Renolit 11 UBRN11/ BRASED Iron BDRN11  
Inseriti: Inox Bond 52 STIB52

BIJOU 1533

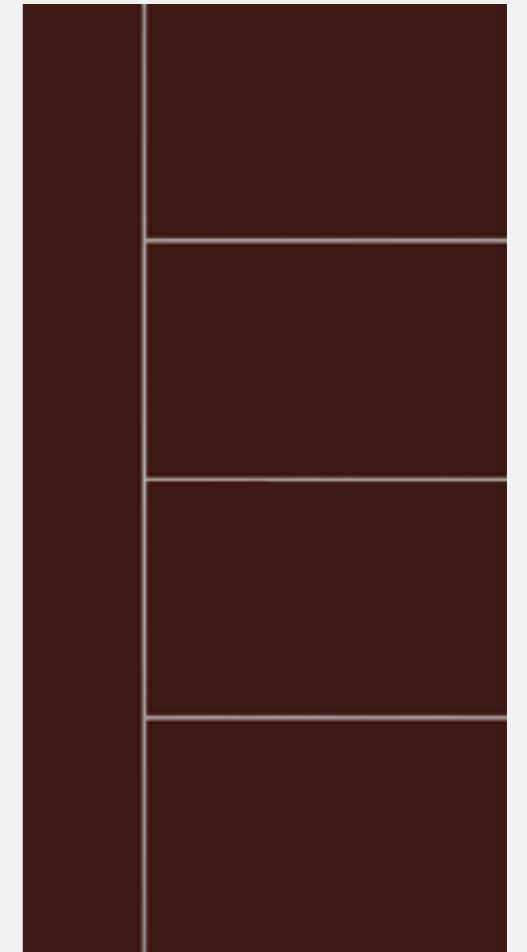

RAL K8017  
Inseriti: Inox Bond 52 STIB52

BIJOU 1533

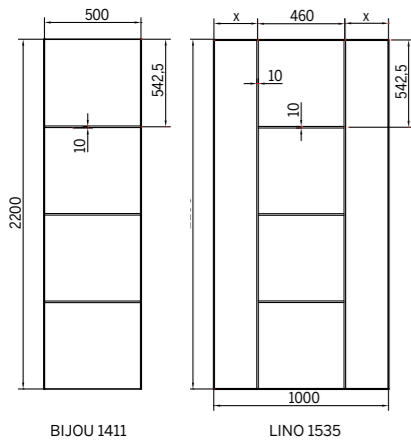

BIJOU 1411

LINO 1535



UBERALL Noce 41 UBNC41  
Inseri: Inox Bond 52 STIB52

LINO 1535

Maniglione BU2364  
ZEN  
Cromo Satinato

Maniglione BU3348  
COOL 400  
Acciaio Inox



PLANA  
IL PORTONCINO ESSENZIALE



VELVET Grigio Fumo VEGFNR / RAL 9006  
Inseri: Inox Bond 52 STIB52

LINO 1535

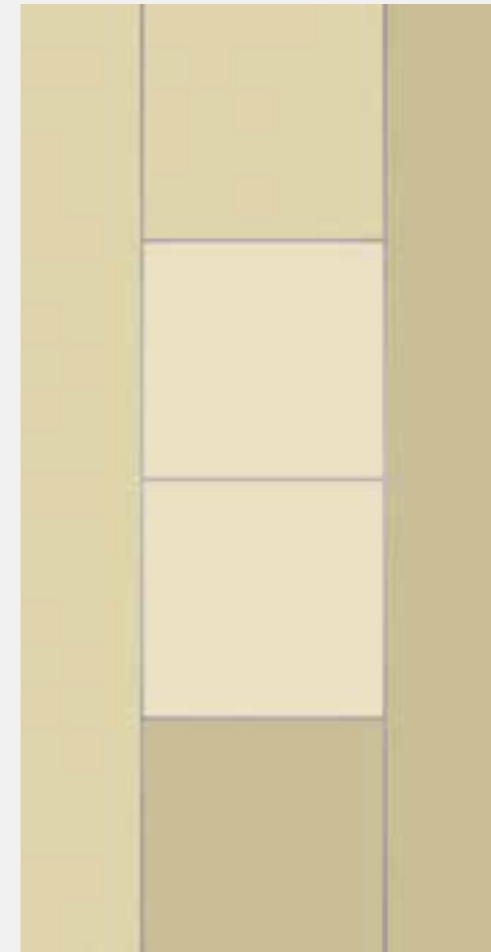

RAL 1014 / 1013 / 1015  
Inseri: Inox Bond 52 STIB52

LINO 1535

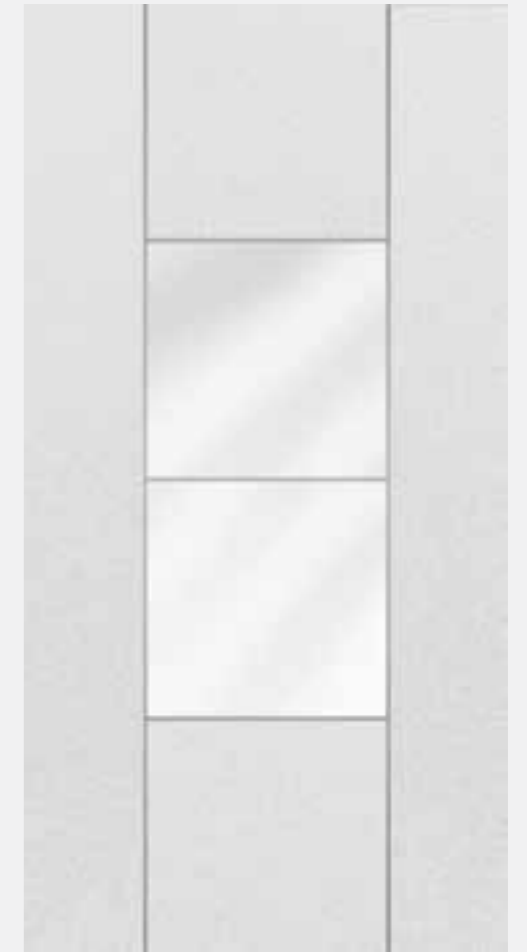

VELVET Artic VEATNR / STAROX Silver 51 STS151  
Inseri: Inox Bond 52 STIB52

LINO 1535



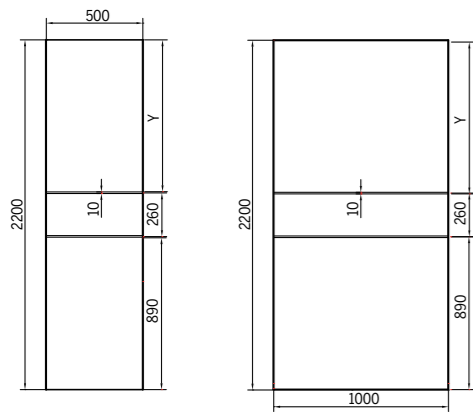

ERMITAGE 1419

ERMITAGE 1519

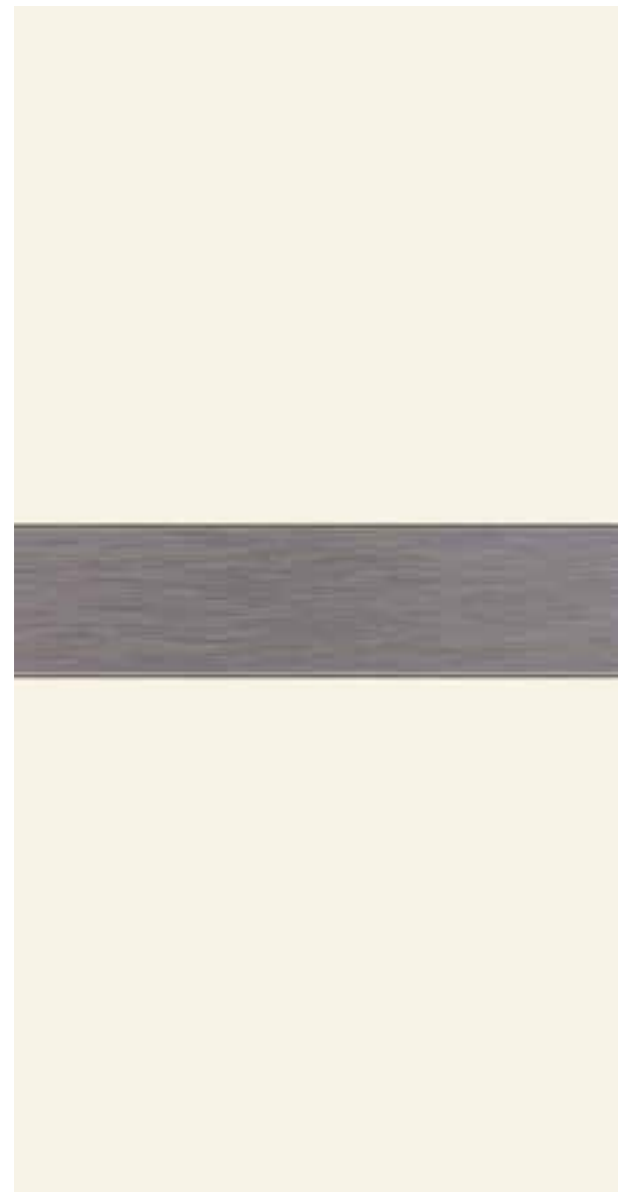

RAL 9010 / BRASED Iron BDRN11  
Inserti: Inox Bond 52 STIB52

ERMITAGE 1519

Maniglione BU890014  
ELLE  
Cromo Satinato

Maniglione BU3748  
MOHICANO  
Acciaio Inox AISI 316L



PLANA  
IL PORTONCINO ESSENZIALE

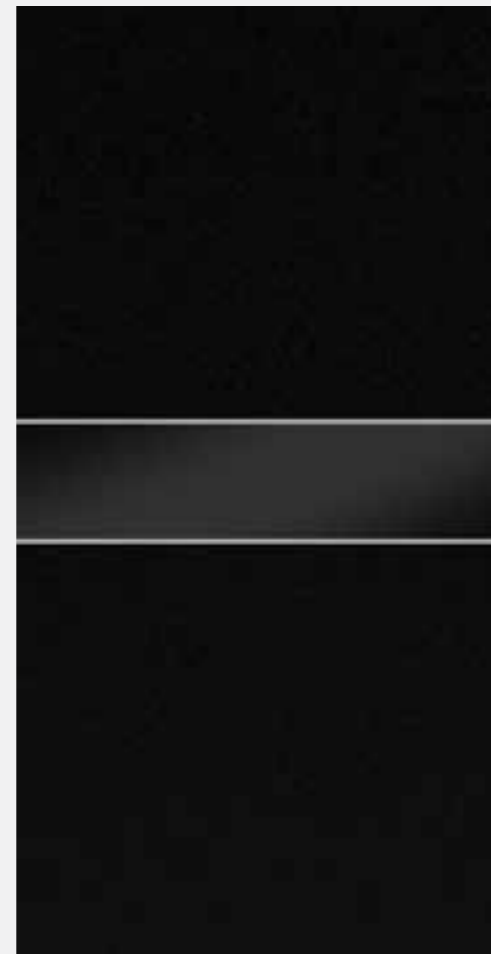

VELVET Neromat VENMNR / STAROX Night 51 STNH51  
Inserti: Inox Bond 52 STIB52

ERMITAGE 1519



STAROX Grigio Fly 51 STGF51  
BRASED Grigio Tungsteno BDTG11  
Inserti: Inox Bond 52 STIB52

ERMITAGE 1519



RAL 9006 / BRASED Grigio Ardesia BDGR11  
Inserti: Inox Bond 52 STIB52

ERMITAGE 1519

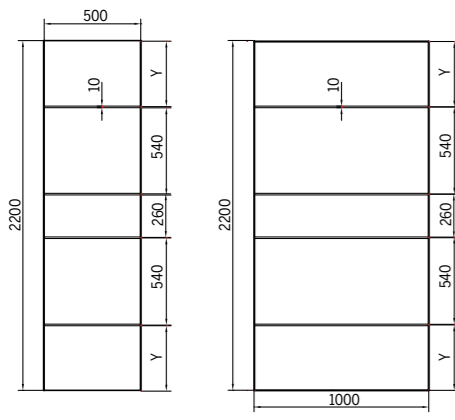

ALBERT 1418

ALBERT 1518



RAL K 6005  
Inseriti: Inox Bond 52 STIB52

ALBERT 1518

Maniglione BU358811  
PUNTATORE  
Acciaio Inox AISI 316L



Maniglione BU3575  
BIRICHINO  
Acciaio Inox AISI 316L

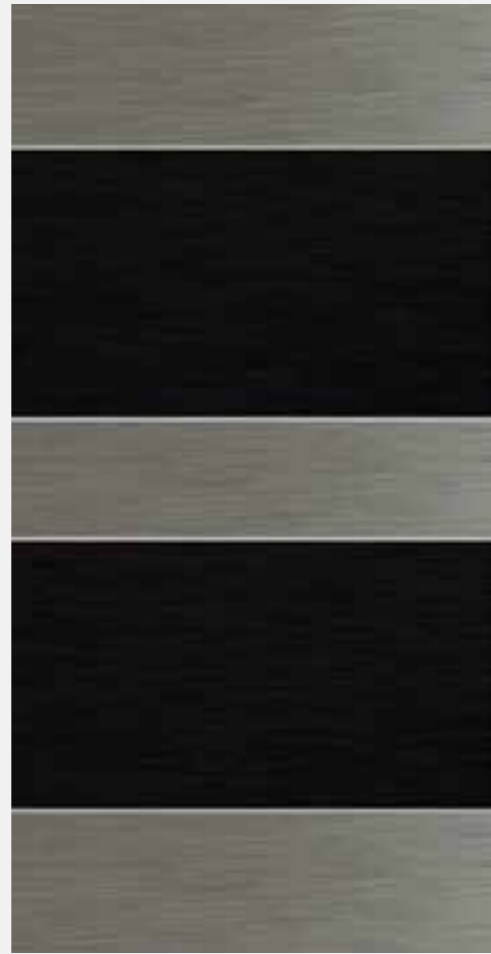

BRASED Iron BDRN11 / BRASED Grigio Ardesia BDGR11  
Inseriti: Inox Bond 52 STIB52

ALBERT 1518



BRASED Specchio BDSH11 / Iron BDRN11  
Grigio Tungsteno BDTG11 / Grigio Ardesia BDTGR11  
Inseriti: Inox Bond 52 STIB52

ALBERT 1518



UBERALL Wengè UBWE11  
Inseriti: Inox Bond 52 STIB52

ALBERT 1518

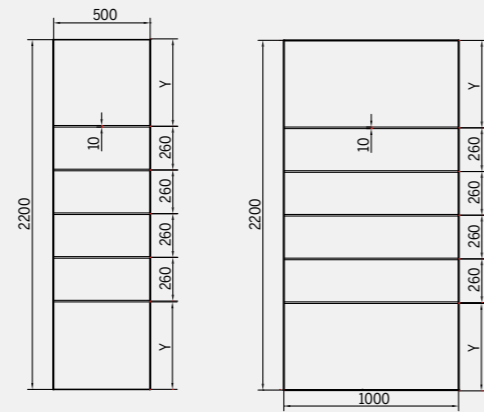

AGUSTA 1416

AGUSTA 1516



UBERALL Noce 41 UBNC41  
Inserti: Inox Bond 52 STIB52

AGUSTA 1516

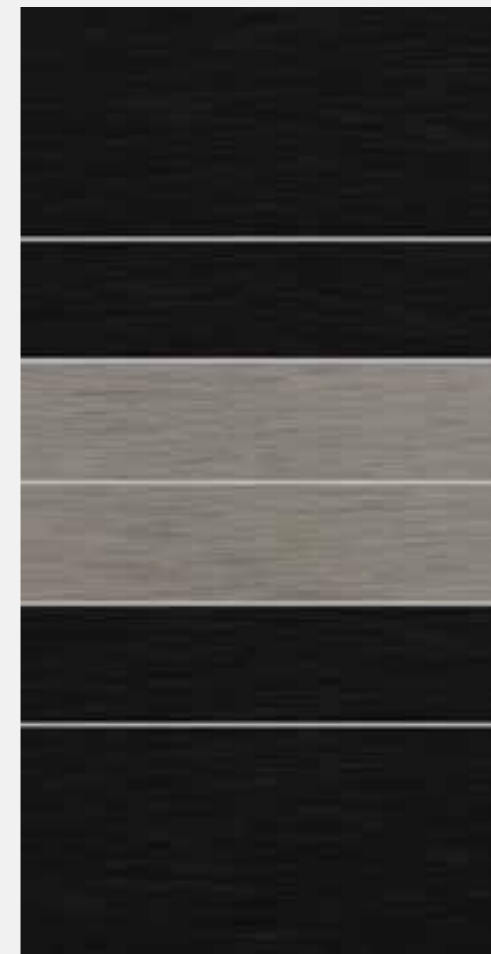

BRASED Grigio Ardesia BDGR11 / Iron BDRN11  
Inserti: Inox Bond 52 STIB52

AGUSTA 1516



BRASED Specchio BDSH11 / UBERALL Renolit 21 UBRN21  
Inserti: Inox Bond 52 STIB52

AGUSTA 1516

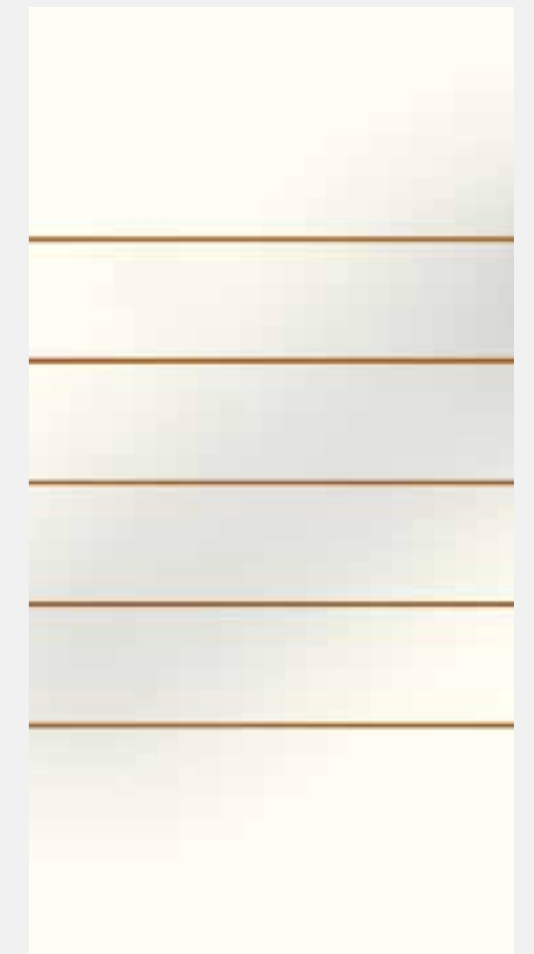

RAL 9010  
Inserti: Ciliegio 42 UBCI42

AGUSTA 1516

Maniglione BU3468  
RAIN 600  
Acciaio Inox

Maniglione BU344  
SOCRATE  
Cromo Satinato



PLANA  
IL PORTONCINO ESSENZIALE

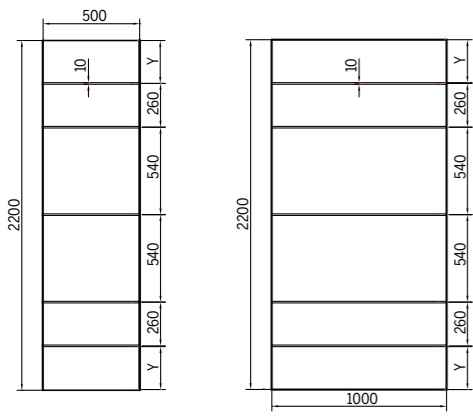

MAO 1417

MAO 1517

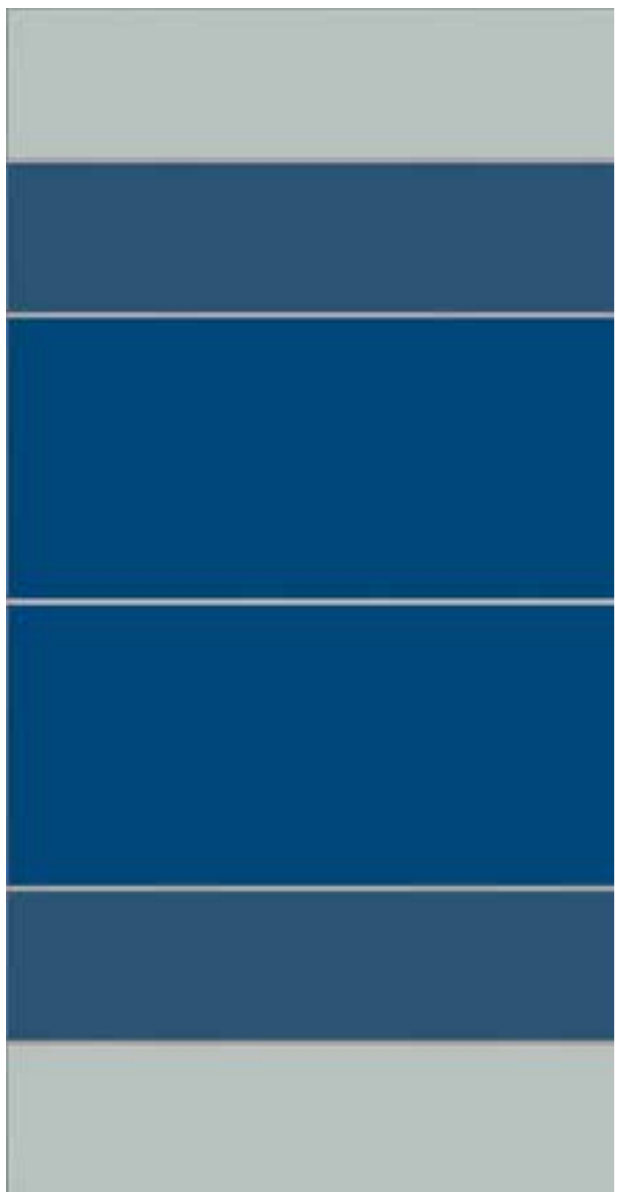

RAL 7035 / 5007 / 5009  
Inseri: Inox Bond 52 STIB52

MAO 1517

Maniglione BU890024  
NOA  
Cromo Satinato



Maniglione BU3648  
TRENDY  
Acciaio Inox AISI 316L



MAO 1517

RAL 9010  
Inseri: Anodizzato Nero OXNE

MAO 1517

RAL 9010 / STAROX Silver 51 STS151  
Inseri: Inox Bond 52 STIB52

MAO 1517

RAL 9010 / VELVET Grigio Fumo VEGFNR / Acciaio VEACNR  
Inseri: Inox Bond 52 STIB52

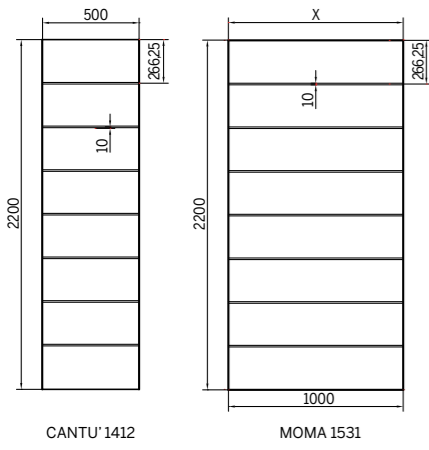

CANTU' 1412

MOMA 1531

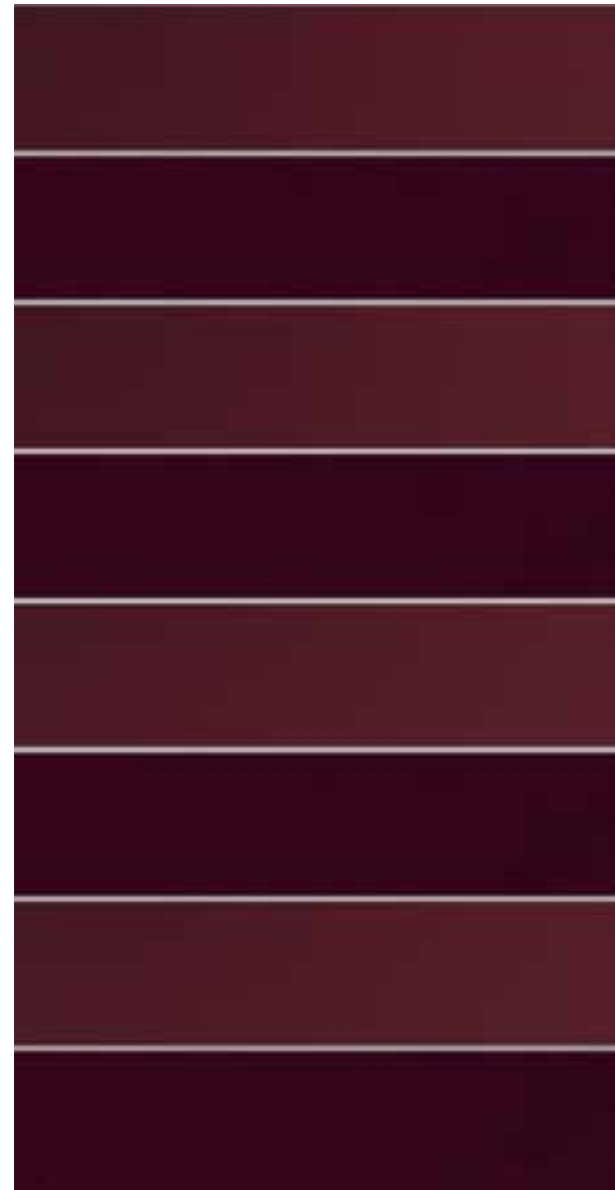

STAROX Rosso Passion 51 STRP51/ VELVET Granata VEGNR  
Inseri: Inox Bond 52 STIB52

MOMA 1531

Maniglione BU890014  
ELLE  
Cromo Satinato



Maniglione BU3438  
RAIN 320  
Acciaio Inox

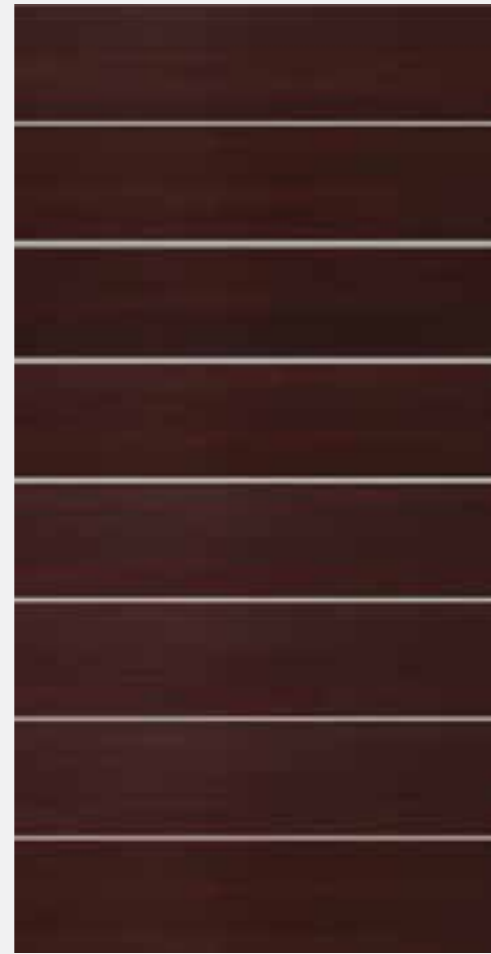

UBERALL Wengè UBWE11  
Inseri: Inox Bond 52 STIB52

MOMA 1531

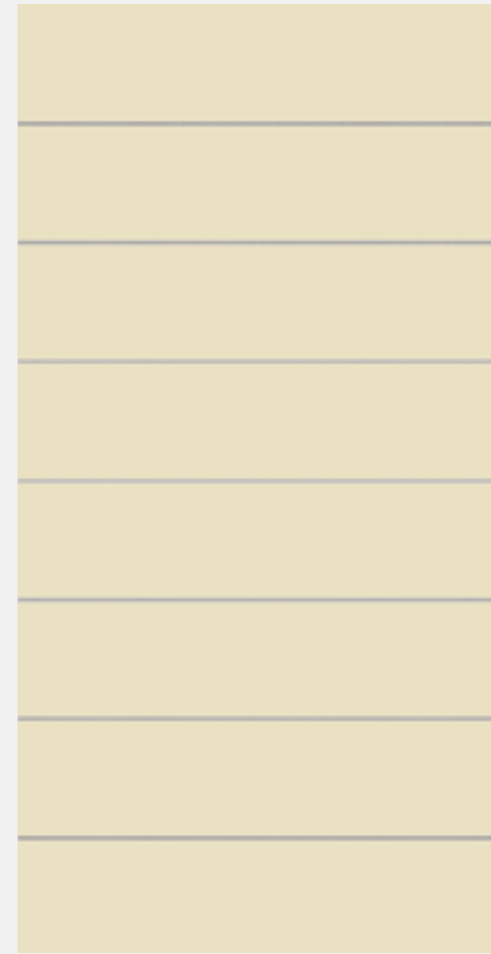

RAL 1013  
Inseri: Inox Bond 52 STIB52

MOMA 1531

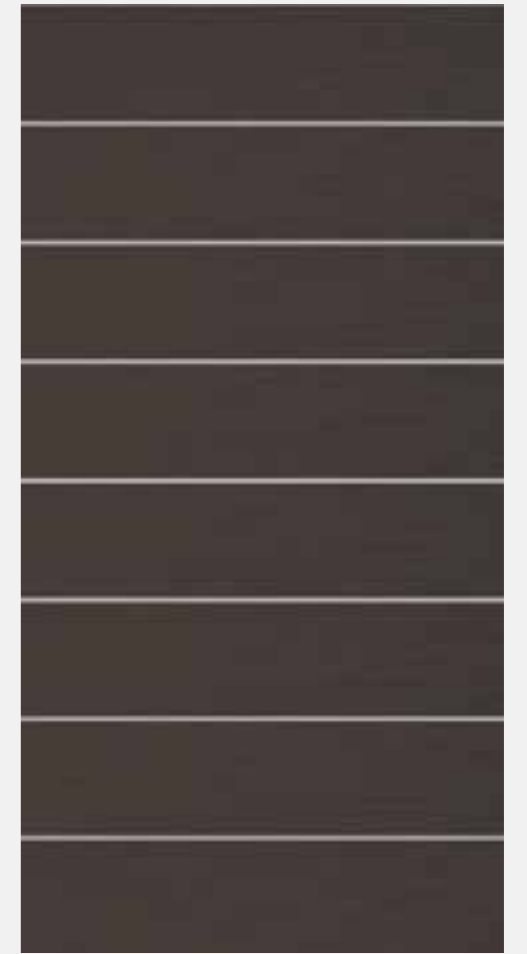

BRASED Ruggine BDGG11  
Inseri: Inox Bond 52 STIB52

MOMA 1531





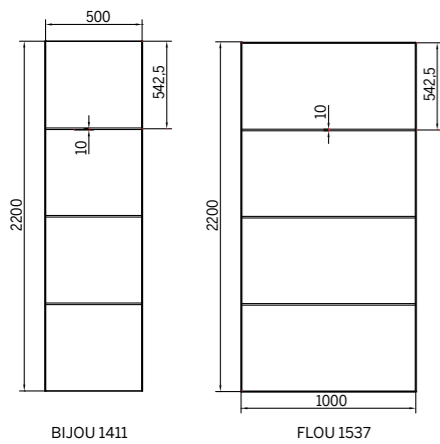

BIJOU 1411

FLOU 1537

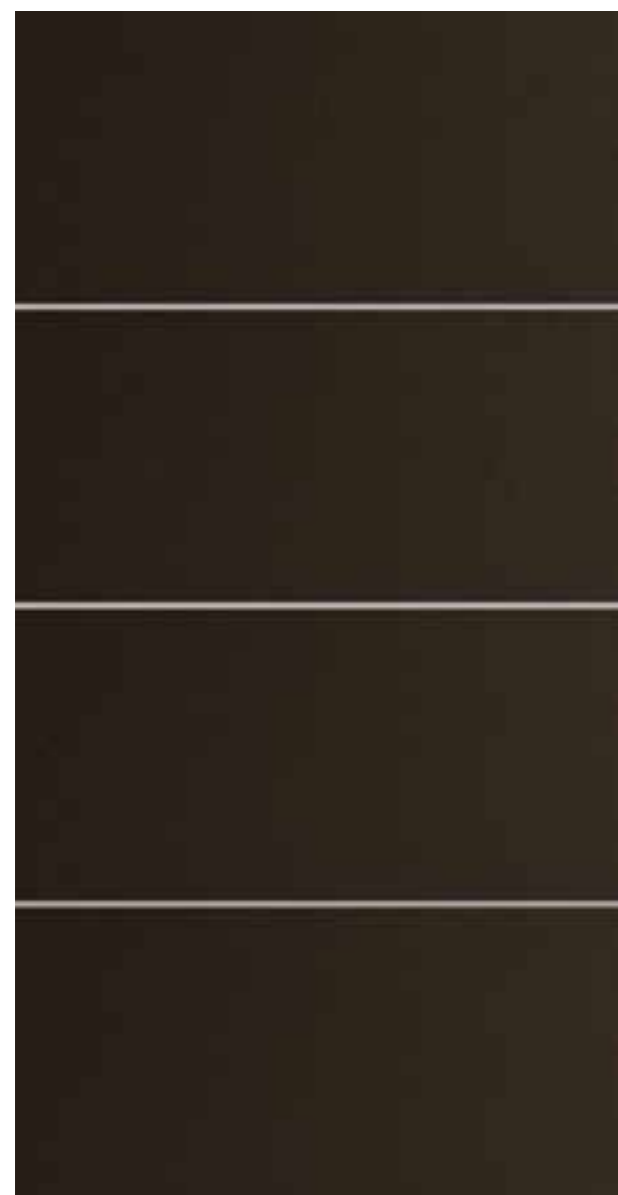

VELVET Cerrano VECRNR  
Inserti: Inox Bond 52 STIB52

FLOU 1537

Maniglione BU890044  
WAVE  
Cromo Satinato



Maniglione BU3598  
TWINS  
Acciaio Inox AISI 316L



UBERALL Renolit 21 UBRN21  
Inserti: Inox Bond 52 STIB52

FLOU 1537



BRASED Iron BDRN11 / Grigio Tungsteno BDTG11  
Inserti: Anodizzato Nero OXNE

FLOU 1537

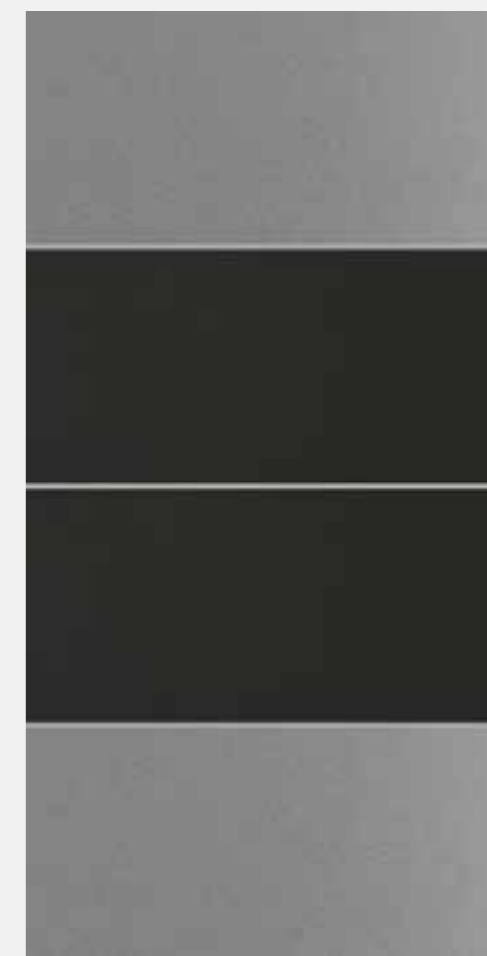

VELVET Artic VEATNR / Grigio Fumo VEGFNR  
Inserti: Inox Bond 52 STIB52

FLOU 1537

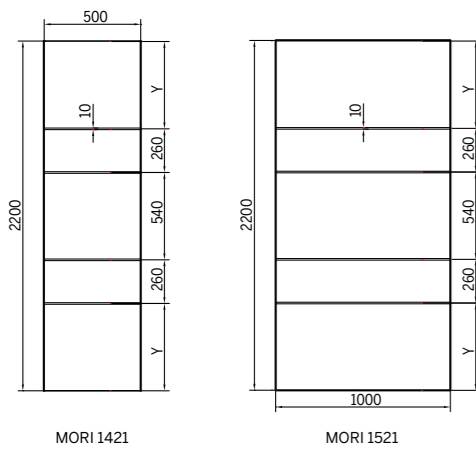

MORI 1421

MORI 1521



POLYCROM Marrone Polvere M7002  
Inserti: Inox Bond 52 STIB52

MORI 1521

Maniglione BU3738  
LUXURY  
Acciaio Inox AISI 316L



Maniglione BU3748  
MOHICANO  
Acciaio Inox AISI 316L



RAL 1013 / BRASED Iron BDRN11  
Inserti: Inox Bond 52 STIB52

MORI 1521



POLYCROM Grigio Polvere M7000  
STAROX Night 51 STNH51  
Inserti: Inox Bond 52 STIB52

MORI 1522



UBERALL Noce 41 UBNC41  
Inserti: Inox Bond 52 STIB52

MORI 1521

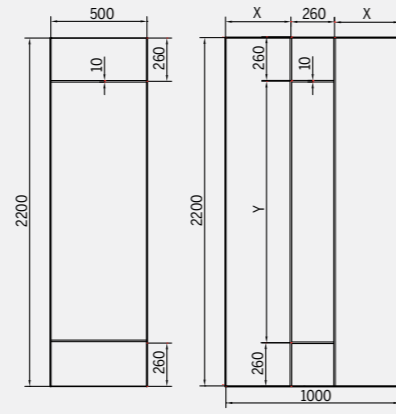

GETTY 1415

ALBO 1524



UBERALL Douglas 31 UBDU31 / STAROX Silver STSI51  
Inserti: Inox Bond 52 STIB52

ALBO 1524



VELVET AcciaioVEACNR / UBERALL Castagno 41 UB41  
VELVET Cerrano VECCRNR  
Inserti: Inox Bond 52 STIB52

ALBO 1524



UBERALL HD Rovere 25USRV25 / BRASED Amaranto BDAN11  
Inserti: Inox Bond 52 STIB52

ALBO 1524

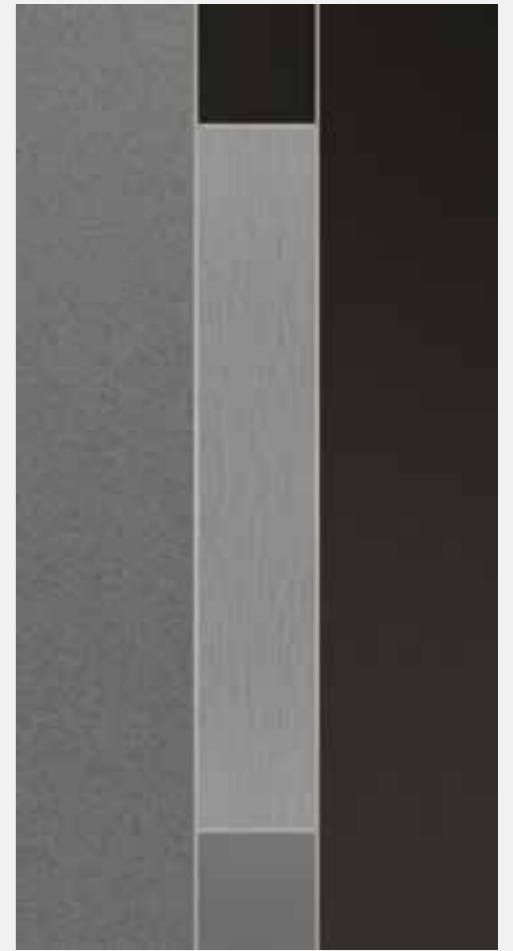

VELVET Artic VEATNR / STAROX Grigio Fly 51 STGF51  
VELVET Neromat VENMNR  
Inserti: Inox Bond 52 STIB52

ALBO 1524

Maniglione BU3529  
WARM 250  
Starox



Maniglione BU3639  
SNOW 300  
Starox



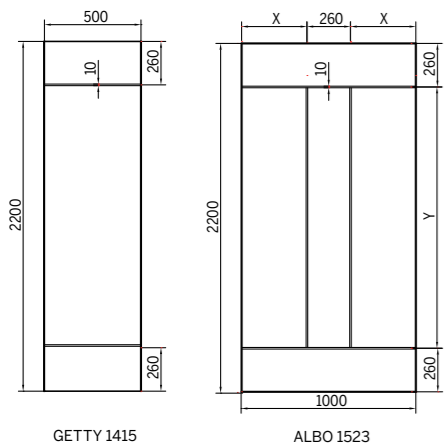

GETTY 1415

ALBO 1523

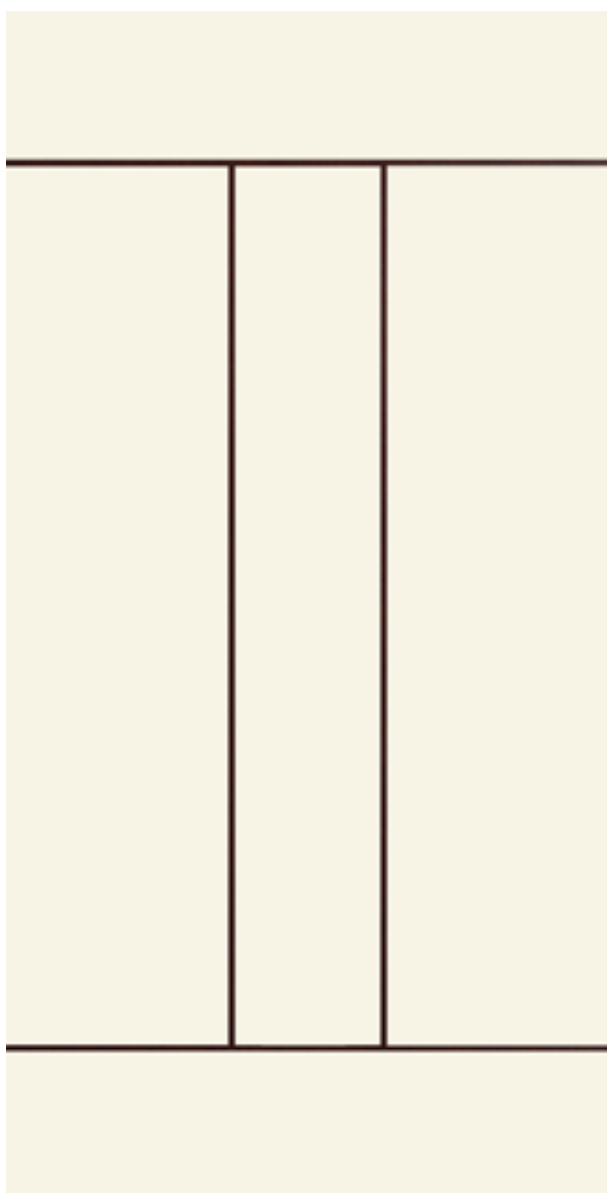

RAL 9010  
Inserti: Noce 43 UBNC43

ALBO 1523

Maniglione BU3588  
PUNTATORE  
Acciaio Inox AISI 316L

Maniglione BU890034  
QUADROZEN  
Cromo Satinato



PLANA  
IL PORTONCINO ESSENZIALE

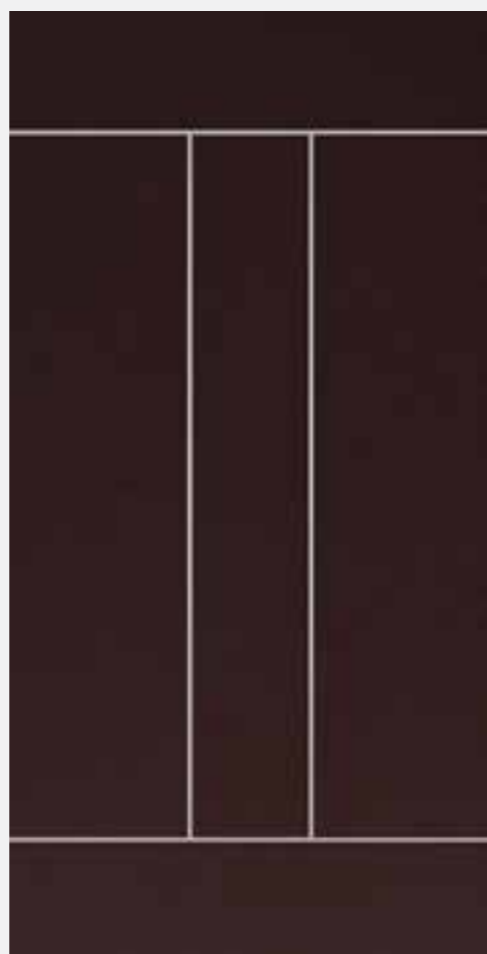

VELVET Granata VEGNR  
Inserti: Inox Bond 52 STIB52

ALBO 1523

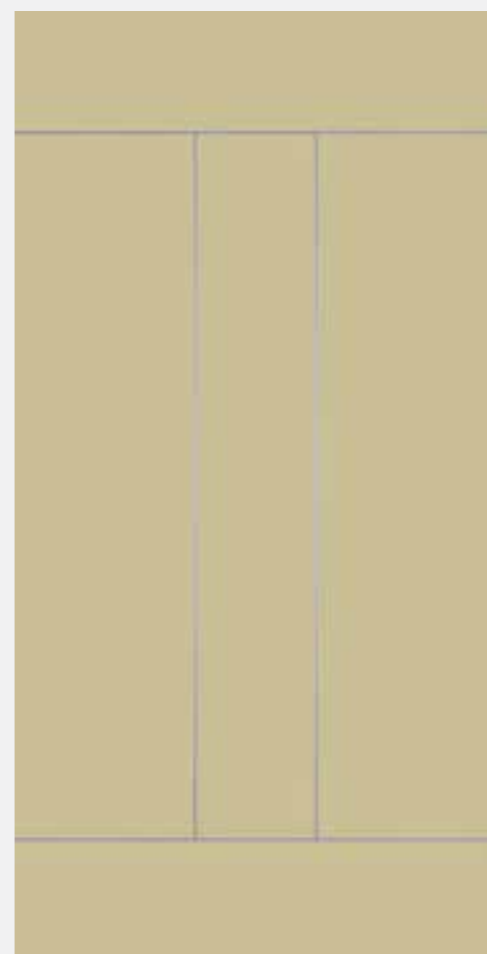

RAL 1013  
Inserti: Inox Bond 52 STIB52

ALBO 1523



UBERALL Renolit 21 UBRN21  
Inserti: Inox Bond 52 STIB52t

ALBO 1523

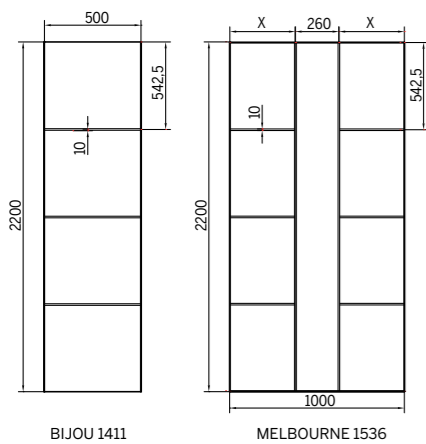

BIJOU 1411

MELBOURNE 1536



POLYCROM Grigio Polvere M 7100 / BRASED Iron BDRN11  
Inserti: Iron BDRN11

MELBOURNE 1536

Pomolo BU5029  
POMOLO FISSO  
Cromo Satinato



Maniglione BU3605  
FASHION  
Acciaio Inox AISI 316L

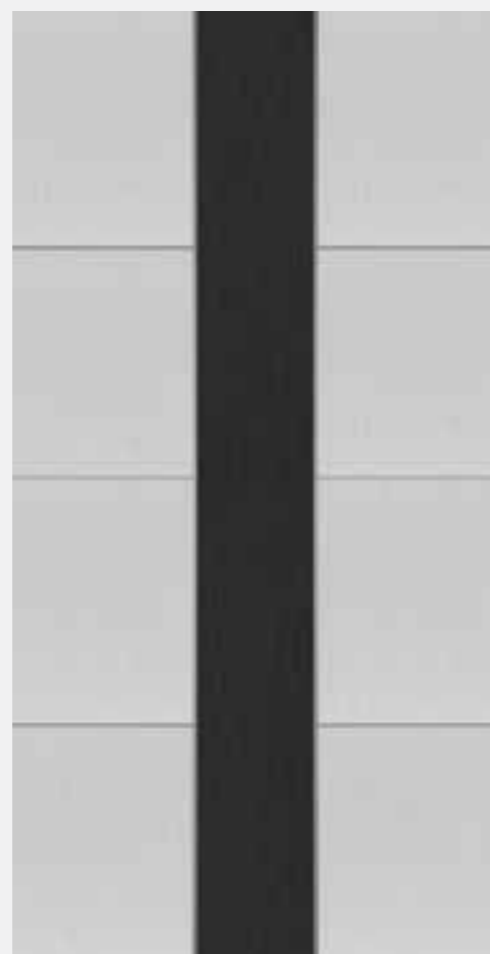

BRASED Specchio BDSH11 / Grigio Ardesia BDGR11  
Inserti: Inox Bond 52 STIB52

MELBOURNE 1536

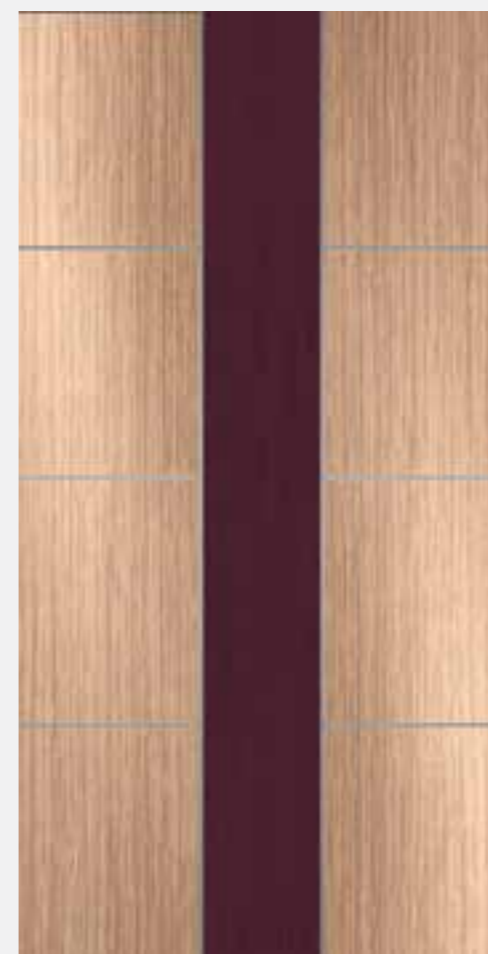

UBERALL HD Rovere 25 USRV25  
BRASED Amaranto BDAM11 / Inserti: Inox Bond 52 STIB52

MELBOURNE 1536



RAL 1013 / UBERALL Renolit 11 UBRN11  
Inserti: Inox Bond 52 STIB52

MELBOURNE 1536



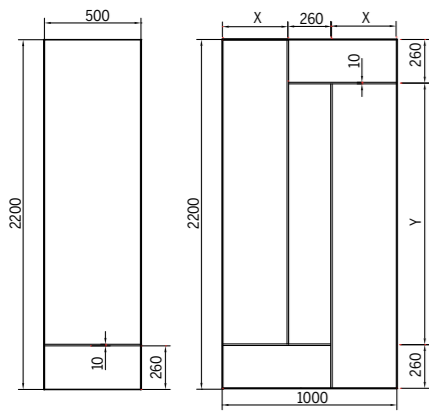

PITT 1414

PITT DX 1525

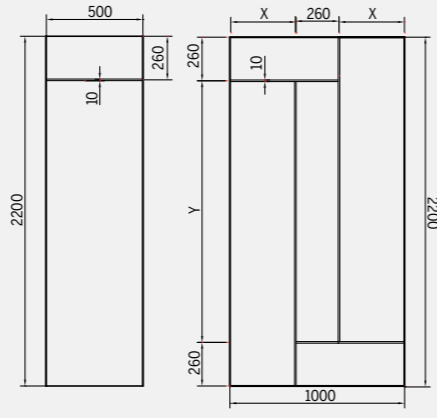

PITT 1413

PITT SX 1527



BRASED Grigio Tungsteno BDTG11 / Iron BDRN11  
Inserti: Iron BDRN11

PITT DX 1525

Maniglione BU890034  
QUADROZEN  
Cromo Satinato



Maniglione BU890024  
NOA  
Cromo Satinato



BRASED Grigio Tungsteno BDTG11 / Iron BDRN11  
Inserti: Iron BDRN11

PITT SX 1527



UBERALL Wengè 11 UBWE11/ STAROX Silver 51 STSI51  
Inserti: Inox Bond 52 STIB52

PITT DX 1525



UBERALL Ciliegio 42 UBCI42  
UBERALL Castagno 41 UBBS41 / RAL 1013  
Inserti: Inox Bond 52 STIB52

PITT DX 1525



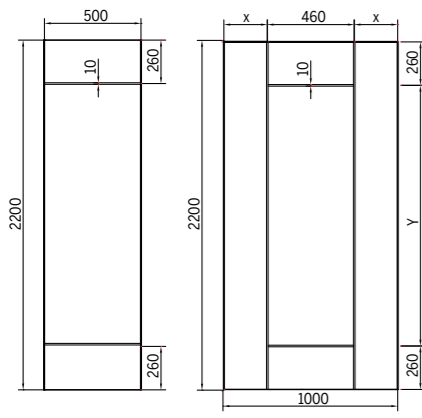

GETTY 1415

GETTY 1522

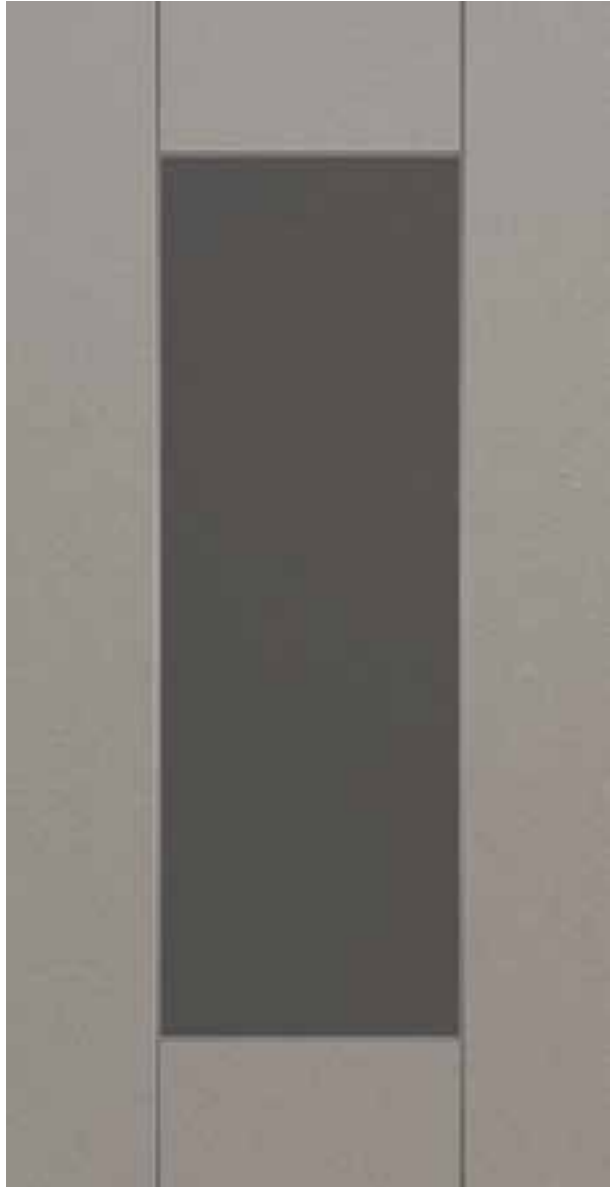

VELVET Acciaio VEACNR / VELVET Grigio Fumo VEGFNR  
Inserti: Inox Bond 52 STIB52

GETTY 1522

Maniglione BU890044  
WAVE  
Cromo Satinato



Maniglione BU3468  
RAIN 600  
Acciaio Inox

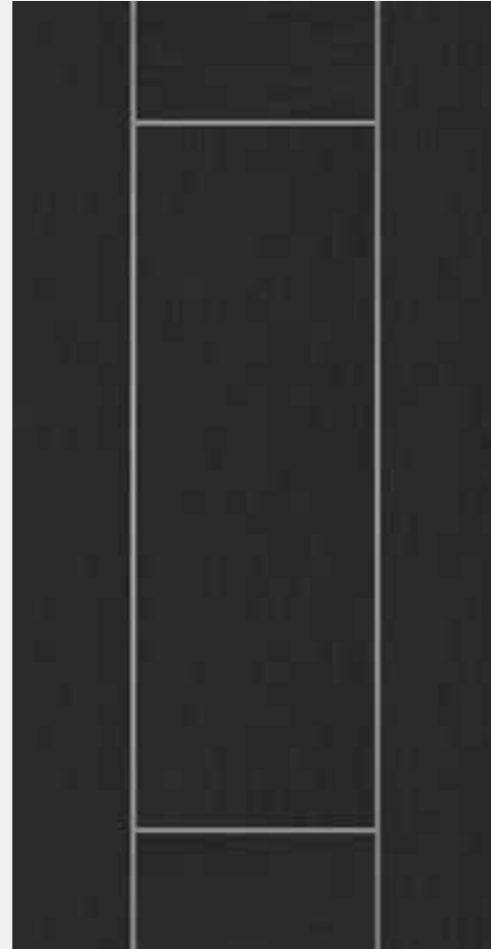

BRASED Grigio Ardesia BDGR11  
Inserti: Inox Bond 52 STIB52

GETTY 1522

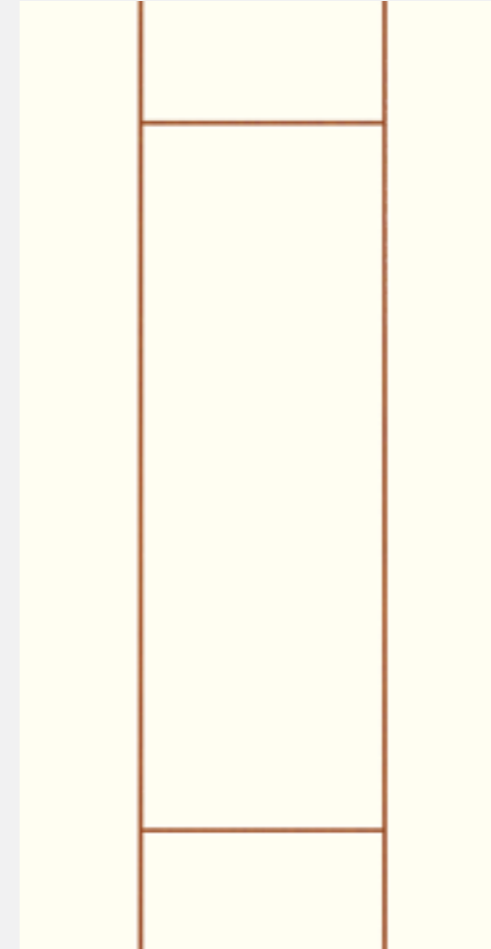

RAL 9010  
Inserti: Noce 43 UBNC43

GETTY 1522



VELVET Granata VEGNR  
STAROX Rosso Passion 51 STRP51  
Inserti: Inox Bond 52 STIB52

GETTY 1522

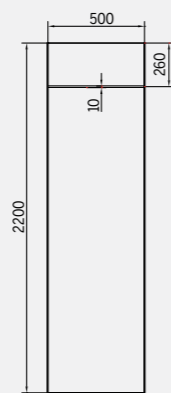

PITTI 1413

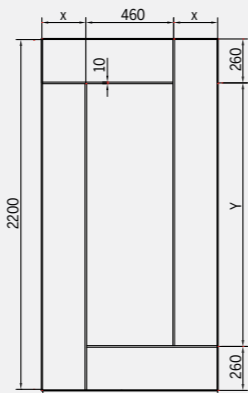

SCOTLAND SX 1528

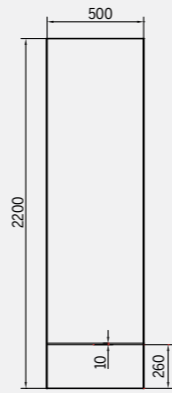

PITTI 1414

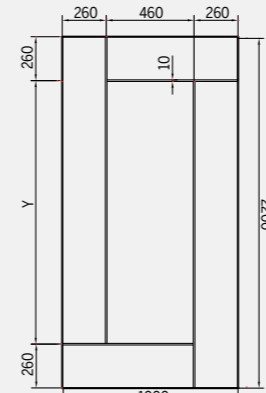

SCOTLAND DX 1526



POLYCROM Ferro Micaceo FEMIC  
Inserti: Inox Bond 52 STIB52 Alluminio

SCOTLAND SX 1528



RAL 1013 / POLYCROM Marrone Corten CORMAR  
Inserti: Inox Bond 52 STIB52

SCOTLAND DX 1526



BRASED Ruggine BDGG11 / Specchio BDSH11  
Inserti: Inox Bond 52 STIB52

SCOTLAND SX 1528



UBERALL Renolit 21 UBRN21/ Renolit 11 UBRN11  
Inserti: Inox Bond 52 STIB52

SCOTLAND SX 1528

Maniglione BU3388  
COOL 800  
Acciaio

Maniglione BU3738  
LUXURY  
Acciaio Inox  
AISI 316L



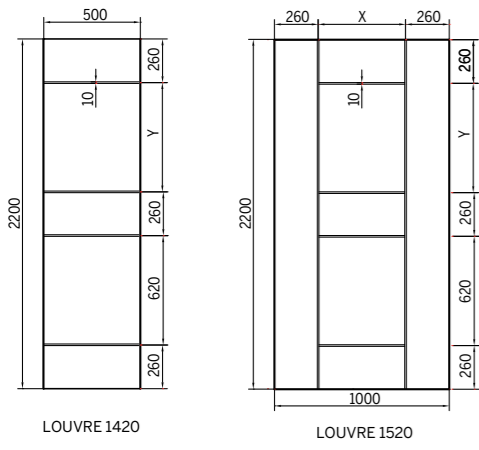

LOUVRE 1420

LOUVRE 1520



VELVET Cerrano VECRNR  
Inseri: Inox Bond 52 STIB52

LOUVRE 1520

Maniglione BU890034  
QUADROZEN  
Cromo Satinato



Pomolo BU5029  
POMOLO FISSO  
Cromo Satinato



PLANA  
IL PORTONCINO ESSENZIALE

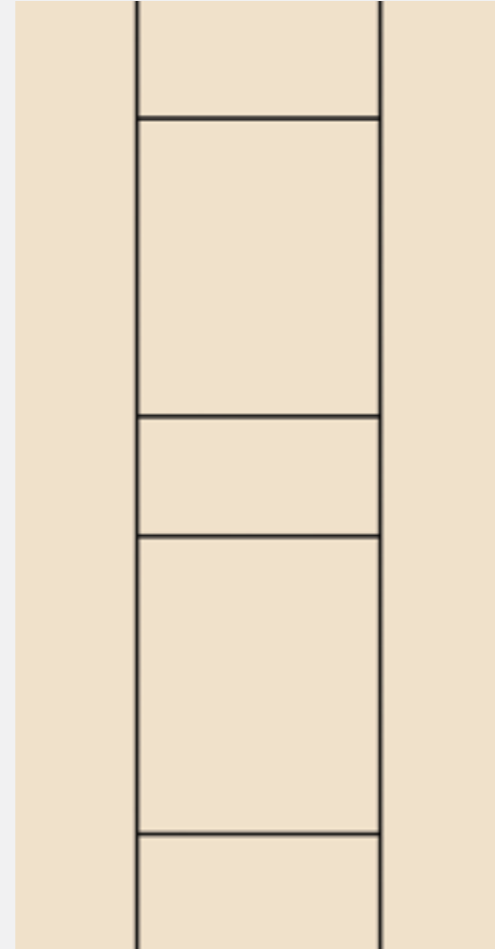

RAL 1013  
Inseri: Anodizzato Nero OXNE

LOUVRE 1520



POLYCROM Verde Polvere M7100  
Inseri: Inox Bond 52 STIB52

LOUVRE 1520



BRASED Iron BDRN11 / Grigio Tungsteno BDTG11  
Inseri: Inox Bond 52 STIB52

LOUVRE 1520



HOLON SX1538



pag. 22



pag. 22



pag. 23



pag. 23

VITRA 1540



pag. 24

LINO 1535



pag. 32



pag. 32



pag. 33



pag. 33

ERMITAGE 1519



pag. 36



pag. 24

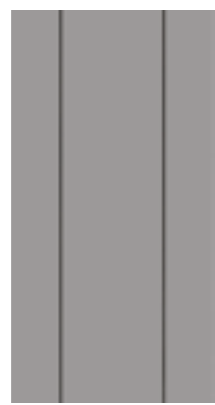

pag. 25



pag. 25

CANTÙ SX1529



pag. 26



pag. 27



pag. 36



pag. 37



pag. 37

ALBERT 1518



pag. 38



pag. 38



pag. 27



pag. 27

DALMINE 1532



pag. 28



pag. 28

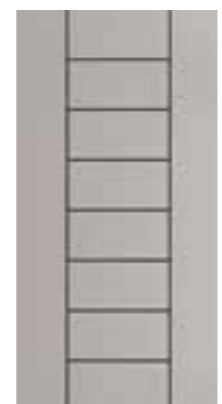

pag. 29



pag. 39



pag. 39

AGUSTA 1516

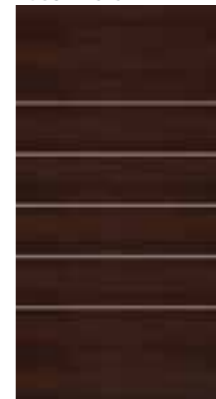

pag. 40



pag. 41



pag. 41



pag. 29

BIJOU SX1533



pag. 30



pag. 30



pag. 31



pag. 31



pag. 41

MAO 1517

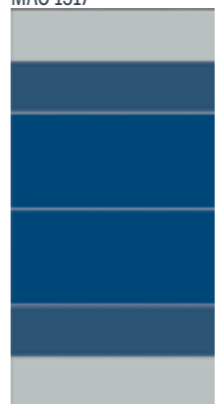

pag. 42



pag. 42

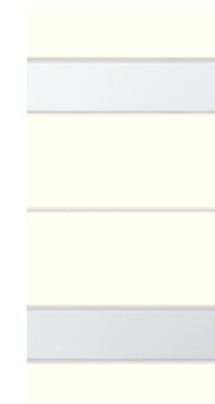

pag. 43

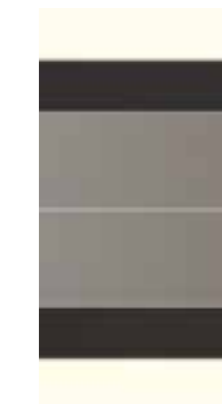

pag. 43

MOMA 1531

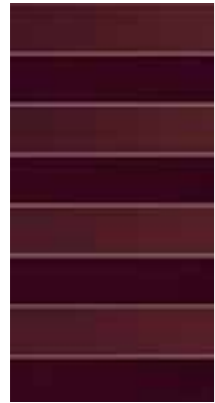

pag. 44

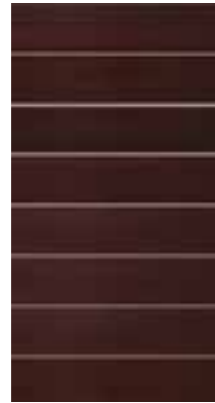

pag. 44

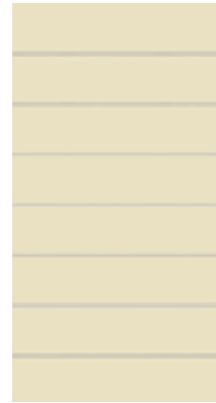

pag. 45



pag. 45

FLOU 1537

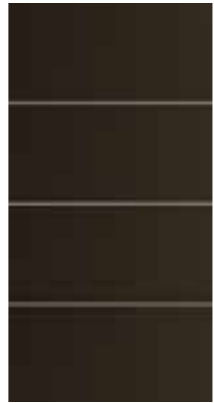

pag. 48

MELBOURNE 1536



pag. 56



pag. 56



pag. 57



pag. 57

PITTI DX 1525



pag. 60



pag. 48



pag. 49

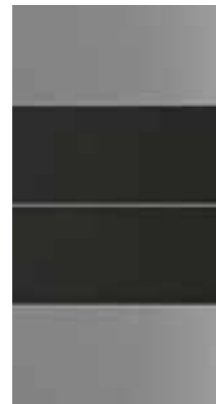

pag. 49

MORI 1521



pag. 50



pag. 50

PITTI SX 1527



pag. 60



pag. 61



pag. 61

GETTY 1522



pag. 62



pag. 62

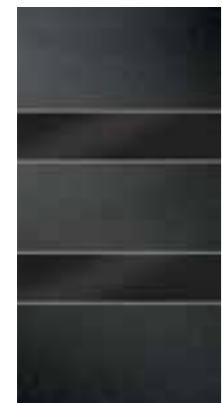

pag. 51



pag. 51

ALBO 1524



pag. 52



pag. 53



pag. 53



pag. 63



pag. 63

SCOTLAND SX 1528



pag. 64

SCOTLAND DX 1526



pag. 65



pag. 65

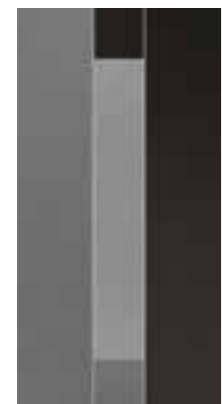

pag. 53

ALBO 1523

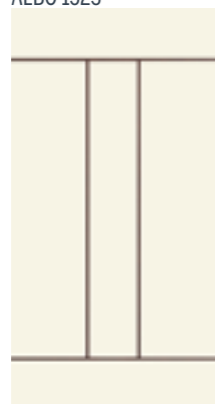

pag. 54



pag. 54



pag. 55



pag. 55



pag. 65

LOUVRE 1520



pag. 66

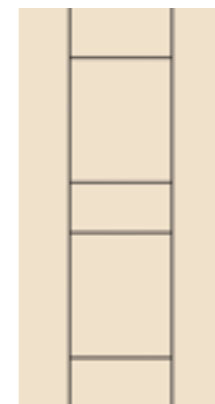

pag. 66



pag. 67



pag. 67

## Colori STANDARD

verniciato, tinta legno, ossidati

## Verniciato:

Lucidi RAL 9010  
RAL 1013  
RAL 9006

Opachi K 9010  
K 1013  
K 6005  
K 8017

M 7000 Grigio Polvere  
M 7100 Verde Polvere  
M 7200 Marrone Polvere  
FEMIC Ferro Micaceo  
CORMAR Marrone Corten

## Tinta legno:

UBNC41 Noce 41  
UBNC43 Noce 43  
UBCS41 Castagno 41  
UBRN21 Renolit 21  
UBRN11 Renolit 11  
UBDU31 Douglas 31  
UBWE11 Wengè 11  
UBCI42 Ciliegio 42  
USRV25 Rovere 25  
HDPL35 Platano 35

## Ossidati:

OXAR Anodizzato Argento  
OXNE Anodizzato Nero  
OXVUNC Anodizzato Argento VUNC

## Colori SPECIALI

starox, brased, velvet

## Starox:

STSI51 Silver 51  
STIB52 Inox Bond 52  
STGF51 Grigio Fly 51  
STNH51 Night 51  
STRP51 Rosso Passion 51

## Brased Ultra:

BDSH11 Specchio  
BDRN11 Iron  
BDTG11 Grigio Tungsteno  
BDGR11 Grigio Ardesia  
BDGG11 Ruggine  
BDAM11 Amaranato

## Velvet Fine:

VEATNR Artic  
VEACNR Acciaio  
VEGFNR Grigio Fumo  
VENMNR Neromat  
VECRNR Cerrano  
VEGRNR Granata

## Colori per inserti in alluminio

## Inserto mm. 10:

RAL 9010  
K 9010  
UBNC43 Noce 43  
UBCI42 Ciliegio 42  
OXNE Anodizzato Nero  
STIB52 Inox Bond 52  
BDRN11 Iron  
BDTG11 Grigio Tungsteno

## Inserto mm. 2:

RAL 9010  
K 9010  
OXNE Anodizzato Nero  
STIB52 Inox Bond 52  
BDRN11 Iron  
BDTG11 Grigio Tungsteno

 **Ponzio**  
Aluminium design since 1941

**IN ESCLUSIVA** **PLANA**  
IL PORTONCINO ESSENZIALE

# LISTINO PREZZI PANNELLI

Dimensioni standard cm. 100x220

## T.H.F.

7 mm	Codice	
	Finiture STANDARD	€ 1.090
	Finiture SPECIALI	€ 1.200
12 mm	Codice	
	Finiture STANDARD	€ 1.120
	Finiture SPECIALI	€ 1.240
15 mm	Codice	
	Finiture STANDARD	€ 1.150
	Finiture SPECIALI	€ 1.270

### NOTE:

- Fuori Misura (misura max cm. 115 x 245)..... + € 200,00/cad.
- Lavorazioni di ribassamento perimetrali..... non realizzabili

### ESEMPIO:

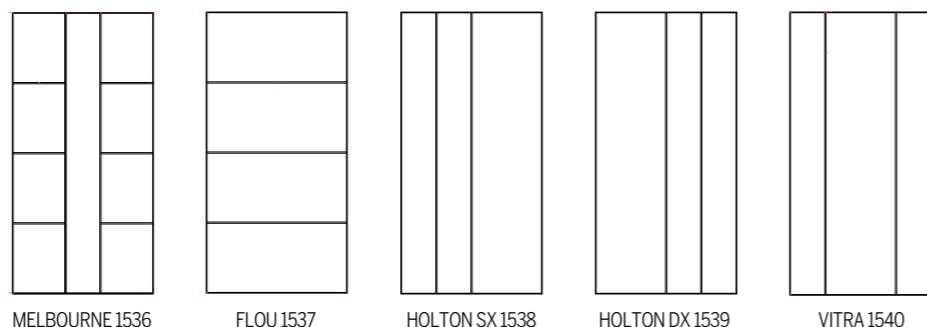
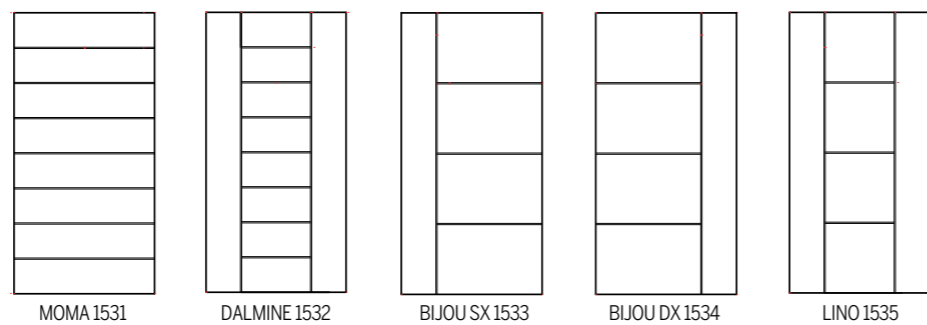
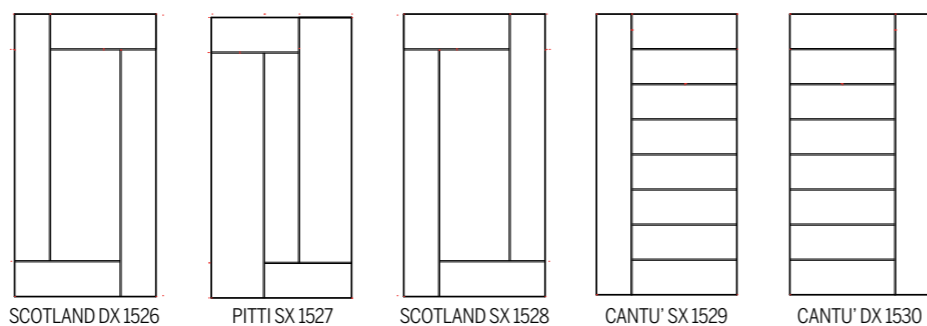
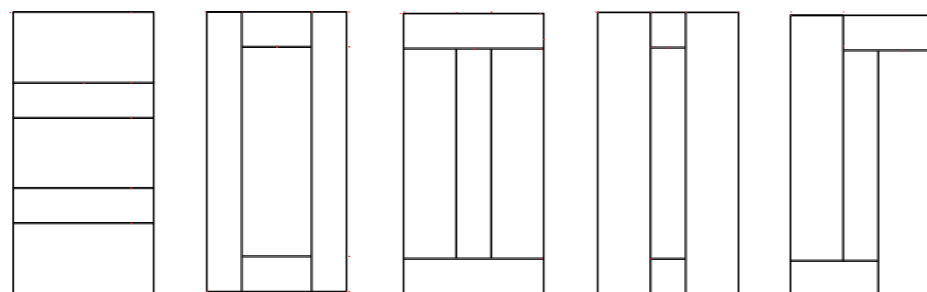
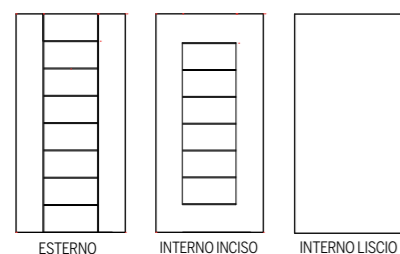

## H.I.++ FLEXIBLE CORE

24 mm	Codice	
	Finiture STANDARD	€ 1.840
	Finiture SPECIALI	€ 2.024
30 mm	Codice	
	Finiture STANDARD	€ 1.890
	Finiture SPECIALI	€ 2.080
35 mm	Codice	
	Finiture STANDARD	€ 1.960
	Finiture SPECIALI	€ 2.156
40 mm	Codice	
	Finiture STANDARD	€ 2.050
	Finiture SPECIALI	€ 2.255

### NOTE:

Il prezzo indicato si riferisce al pannello con lato esterno lavorato ad inserti nel modello scelto e lato interno liscio o inciso.

- Lato interno con lavorazione ad inserti..... + € 560,00/cad. (come lato esterno)
- Fuori Misura (misura max cm. 115 x 245)..... + € 240,00/cad.

# LISTINO PREZZI ANTINE

Dimensioni standard cm. 50x220

## T.H.F.

7 mm	Codice	
	Finiture STANDARD	€ 545
	Finiture SPECIALI	€ 600
12 mm	Codice	
	Finiture STANDARD	€ 560
	Finiture SPECIALI	€ 620
15 mm	Codice	
	Finiture STANDARD	€ 575
	Finiture SPECIALI	€ 635

### NOTE:

- Fuori Misura (misura max cm. 58 x 245)..... + € 100,00/cad.
- Lavorazioni di ribassamento perimetrali..... non realizzabili

### ESEMPIO:

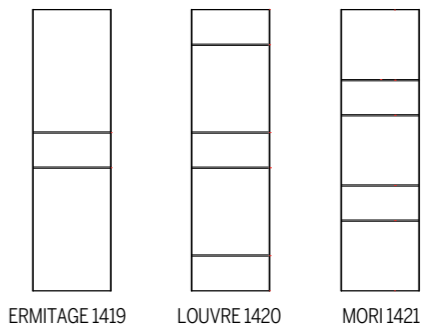
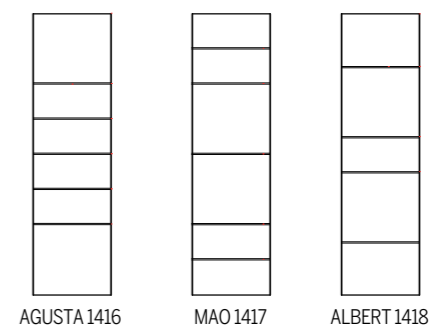
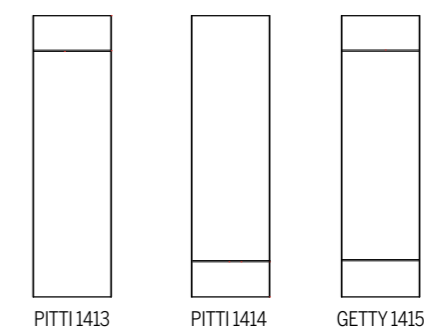
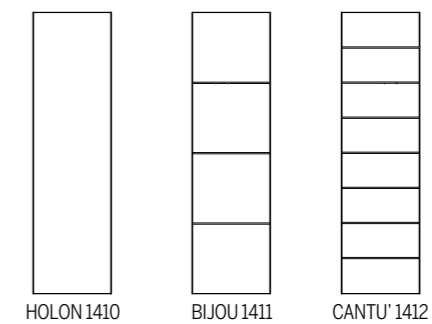
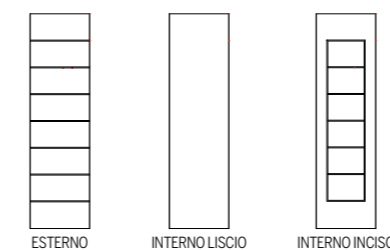

## H.I.++ FLEXIBLE CORE

24 mm	Codice	
	Finiture STANDARD	€ 920
	Finiture SPECIALI	€ 1.012
30 mm	Codice	
	Finiture STANDARD	€ 945
	Finiture SPECIALI	€ 1.040
35 mm	Codice	
	Finiture STANDARD	€ 980
	Finiture SPECIALI	€ 1.078
40 mm	Codice	
	Finiture STANDARD	€ 1.025
	Finiture SPECIALI	€ 1.127

### NOTE:

Il prezzo indicato si riferisce al pannello con lato esterno lavorato ad inserti nel modello scelto e lato interno liscio o inciso.

- Lato interno con lavorazione ad inserti..... + € 280,00/cad. (come lato esterno)
- Fuori Misura (misura max cm. 58 x 245)..... + € 120,00/cad.





ACCESSORI

	Quadro attacco fisso	Quadro attacco girevole	Quadro attacco girevole	Bocchetta x serratura chiave sagomata
Finitura				Cromosat
Codice	BU01	BU02	BU03	BU034
Prezzo	€ 8,00	€ 11,00	€ 7,00	€ 15,00
	Bocchetta x serratura chiave sagomata	Bocchetta x serratura chiave sagomata	Bocchetta x serratura chiave sagomata	Bocchetta x serratura chiave sagomata
Finitura	Neromat	Patinet Steel	Acciaio	STAROX
Codice	BU035	BU037	BU038	BU039
Prezzo	€ 13,00	€ 14,00	€ 14,00	€ 14,00
	Bocchetta "defender"	Bocchetta "defender"	Bocchetta "defender"	Fissaggio per Maniglione acciaio inox
Finitura	Acciaio AISI 316L neromat	Acciaio AISI 316L	Cromosat	
Codice	BU065	BU068	BU074	BU075
Prezzo	€ 13,00	€ 15,00	€ 86,00	€ 14,00
	Fissaggio per Maniglione acciaio inox	Fissaggio sing. per Maniglione BU3648	Maniglione Elle	Maniglione Noa
Finitura			Cromo sat.	Cromo sat.
Codice	BU076	BU077	BU890014	BU890024
Prezzo	€ 11,00	€ 11,00	€ 90,00	€ 330,00
	Maniglione Quadrozen	Maniglione Wave	Maniglione Socrate	Spioncino
Finitura	Cromo sat.	Cromo sat.	Cromo sat.	Nickel cromato
Codice	BU890034	BU890044	BU344	BU894
Prezzo	€ 274,00	€ 580,00	€ 264,00	€ 9,00

ACCESSORI



Pomolo maniglia Marte  
Cromo sat.  
BU1324  
€ 84,00



Pomolo maniglia Marte  
STAROX  
BU1329  
€ 62,00



Pomolo Saturno  
Cromo sat.  
BU1364  
€ 74,00



Maniglia  
Acciaio inox AISI 316  
BU1754  
€ 33,00



Maniglia  
Acciaio inox AISI 316  
BU1764  
€ 102,00



Maniglia  
Acciaio inox AISI 316  
BU1774  
€ 84,00



Maniglione Zen  
Cromo sat.  
BU2364  
€ 305,00



Rosetta Nero  
Acciaio inox AISI 316L (nero)  
BU2495  
€ 29,00



Rosetta  
Acciaio inox AISI 316L  
BU2498  
€ 31,00



Rosetta Bianca  
Acciaio inox AISI 316L (bianco)  
BU249811  
€ 29,00



Rosetta nero  
Acciaio inox AISI 316L (nero)  
BU2505  
€ 29,00



Rosetta  
Acciaio inox AISI 316L  
BU2508  
€ 31,00



Maniglione Cool 200  
Acciaio inox  
BU3328  
€ 310,00



Maniglione Cool 400  
Acciaio inox  
BU3348  
€ 444,00



Maniglione Cool 800  
Acciaio inox  
BU3388  
€ 621,00



Maniglione Rain 320  
Acciaio inox  
BU3438  
€ 306,00



Maniglione Rain 600  
Acciaio inox  
BU3468  
€ 398,00



Maniglione Warm 250  
Neromat  
BU3525  
€ 247,00



Maniglione Warm 250  
Starox  
BU3529  
€ 295,00



Maniglione Warm 400  
Neromat  
BU3545  
€ 341,00

ACCESSORI



Maniglione Warm 400  
Starox  
BU3549  
€ 411,00



Maniglione Birichino  
Acciaio inox AISI 316L (nero)  
BU3575  
€ 302,00



Maniglione Birichino  
Acciaio inox AISI 316L  
BU3578  
€ 315,00



Maniglione Puntatore  
Acciaio inox AISI 316L (nero)  
BU3585  
€ 260,00



Maniglione Puntatore  
Acciaio inox AISI 316L  
BU3588  
€ 278,00



Maniglione Puntatore  
Acciaio inox AISI 316L (bianco)  
BU358811  
€ 356,00



Maniglione Twins  
Acciaio inox AISI 316L (nero)  
BU3595SX  
€ 240,00



Maniglione Twins  
Acciaio inox AISI 316L (nero)  
BU3595DX  
€ 240,00



Maniglione Twins  
Acciaio inox AISI 316L  
BU3598SX o BU3598DX  
€ 251,00



Maniglione Fashion  
Acciaio inox AISI 316L (nero)  
BU3605  
€ 280,00



Maniglione Fashion  
Acciaio inox AISI 316L  
BU3608  
€ 300,00



Maniglione Snow 300  
Neromat  
BU3635  
€ 363,00



Maniglione Snow 300  
Starox  
BU3639  
€ 435,00



Maniglione Trendy  
Acciaio inox AISI 316L  
BU3648  
€ 135,00



Maniglione Magnetic  
Acciaio inox AISI 316L  
BU3678  
€ 211,00



Maniglione Luxury  
Acciaio inox AISI 316L  
BU3738  
€ 329,00



Maniglione Mohicano  
Acciaio inox AISI 316L  
BU3748  
€ 231,00



Pomolo fisso  
Cromo sat.  
BU5029  
€ 181,00



Maniglia Louise  
Cromo sat.  
BU8604  
€ 77,00



Maniglia Thelma  
Cromo sat.  
BU8704  
€ 77,00

 **Ponzio**  
Aluminium design since 1941



PROGRAMMA FINITURE STANDARD | Surface finishings program

IN ESCLUSIVA  
PLANA  
IL PORTONCINO ESSENZIALE

PROGRAMMA FINITURE SPECIALI | Exclusive surface finishings program

IN ESCLUSIVA  
PLANA  
IL PORTONCINO ESSENZIALE



Ral K 6005



Anodizzato Nero OXNE



Noce 41 UBNC41



Rovere 25 USRV25



Silver 51 STSI51



Grigio Fumo VEGFNR



Specchio BDSH11



**Verniciati lucidi e opachi**  
Painted glossy and Matt



**Ossidati e Verniciati con effetti speciali**  
Oxidized and varnished with special effects



**Effetto legno**  
Wood effect



**Effetto legno garantito**  
Guaranteed wood effect



**Anodizzato Colorato**  
Coloured anodized finish



**Anodizzato Vellutato**  
Silky Anodized



**Anodizzato Graffiato**  
Scratched anodized



Ral 9010



Anodizzato Argento Vunc OXVUNC



Noce 43 UBNC43



Platano 35 HDPL35



Inox Bond 52 STIB52



Artic VEATNR



Iron BDRN11

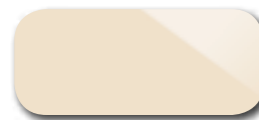

Ral 1013



Argento Spazzolato OXAR



Wengè UBWE11



Grigio Fly 51 STGF51



Acciaio VEACNR



Grigio Tungsteno BDTG11



Ral 9006



Grigio Polvere M7000



Castagno 41 UBNS41



Night 51 STNH51



Granata VEGNR



Amaranto BDAM11

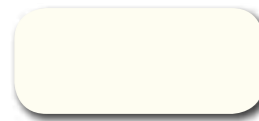

Ral K 9010



Verde Polvere M7100



Renolit 11 UBRN11



Rosso Passion 51 STRP51

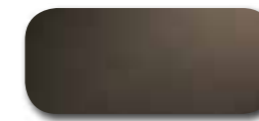

Cerrano VECNR

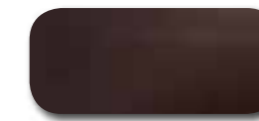

Ruggine BDGG11



Ral K 1013



Marrone Polvere M7200



Renolit 21 UBRN21



Ral K 8017



Ferro Micaceo FEMIC



Ciliegio 42 UBCI42



Marrone Corten CORMAR



Douglas 31 UBDU31

INSERTI | inserts

10 mm.



Ral 9010



K 9010



Noce 43 UBNC43



Ciliegio 42 UBCI42



Anodizzato Nero OXNE



Inox Bond 52 STIB52



Iron BDRN11



Grigio Tungsteno BDTG11

2 mm.



Ral 9010



K 9010



Anodizzato Nero OXNE



Inox Bond 52 STIB52



Iron BDRN11



Grigio Tungsteno BDTG11



PLANA  
IL PORTONCINO ESSENZIALE