

PERSEA[®]
SISTEMI PORTE INTERNE



CARATTERISTICHE TECNICHE

- Sistema per la costruzione di porte interne a battente con una o più ante
- Estrusi in lega di alluminio EN AW 6060 (UNI EN 573-3:1996 e EN 755-2:1999)
- Stato di fornitura T5 (UNI EN 515:1996)
- Tolleranza dimensionale e spessori conformi alla norma UNI EN 12020-2:2002
- Profondità anta 50 mm
- Larghezza nodo centrale 89/152 mm
- Fuga tra i profili 6 mm
- Spessore massimo vetro o pannello 40 mm
- Assemblaggio a 45°
- Accessori propri del sistema
- Guarnizione di battuta

TRACCIA DI CAPITOLATO

Fornitura e posa in opera di serramenti realizzati con i profili in alluminio del sistema "Persea porte interne".

I profilati dovranno essere realizzati mediante estrusione in lega di alluminio EN AW 6060-T5 con spessori e tolleranze dimensionali conformi alla norma UNI EN 12020-2:2002.

Il montaggio dovrà avvenire mediante tagli e giunzioni a 45°. L'anta avrà una profondità di 50 mm. Il nodo centrale avrà larghezza di 89 o 152 mm a seconda dell'anta usata, mentre il nodo laterale avrà larghezza di 67 o 98 mm sempre a seconda dell'anta usata.

L'assemblaggio dei profili sarà effettuato mediante squadrette in pressofuso a bottone o in alluminio estruso a cianfrinare o spinare.

Le guarnizioni e gli accessori utilizzati per il sistema sono originali, studiati e prodotti appositamente, e saranno scelti in funzione delle dimensioni e del peso del serramento a garanzia delle prestazioni dello stesso.

La protezione dei profilati viene effettuata mediante ossidazione anodica con classe di spessore maggiore di 15 micron, o mediante verniciatura a polveri di poliesteri termoindurenti e polimerizzate in forno con spessore medio garantito di 60 micron per le parti principali in vista, in conformità con le disposizioni contenute nelle norme europee UNI 10681:1998 e UNI 9983:1992, e nel rispetto delle procedure previste rispettivamente dai marchi di qualità Qualital: QUALANOD e QUALICOAT.



PERSEA[®]
SISTEMI PORTE INTERNE





INDICE



ACCESSORI	pag	1
PROFILI	pag	3
DETTAGLIO PROFILI	pag	7
SCHEMI DI MONTAGGIO	pag	13
LISTE DI TAGLIO	pag	31



PERSEA[®]
SISTEMI PORTE INTERNE



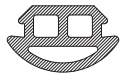
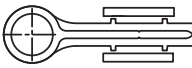

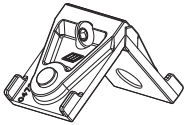
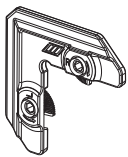
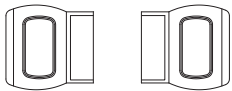
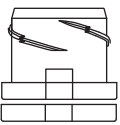

ACCESSORI





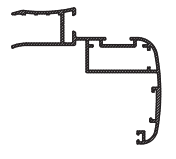
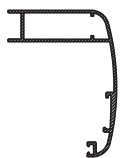
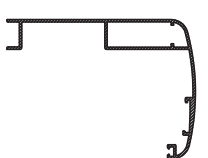
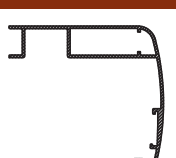

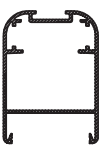
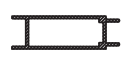
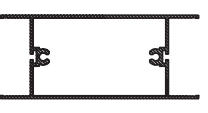

ARTICOLO	CODICE	DESCRIZIONE	CONF.	PREZZO
	ACAS 021	GUARNIZIONE A PALLONCINO		
	ACAS 032	GUARNIZIONE DI BATTUTA TELAIO		
	ACAS 033	CERNIERA		
	ACAS 034	SPAZZOLINO 6,9X1.000		
	ACAS 035	SQUADRETTA A PULSANTE		
	ACAS 003	SQUADRETTA DI ALLINEAMENTO		
	ACAS 036	PREMI E APRI		
	ACAS 037	REGOLO A MURO		





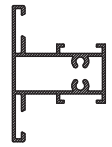
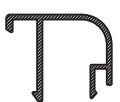

PROFILI

 PROFILO	CODICE	DESCRIZIONE	 gr/ml	Sup.0x	Jx cm ⁴	Jy cm ⁴
	PSPI 401	TELAIO	1.380			
	PSPI 402	IMBOTTE 60 mm	760			
	PSPI 403	IMBOTTE 110 mm	1.169			
	PSPI 404	IMBOTTE 85 mm	1.075			
	PSPI 405	ANTA	730			
	PSPI 406	ANTA MAGGIORATA	980			
	PSPI 407	PROLUNGA IMBOTTE	490			
	PSPI 408	FASCIA	1.260			



 PROFILO	CODICE	DESCRIZIONE	 gr/ml	Sup.0x	Jx cm ⁴	Jy cm ⁴
	PSPI 409	PROFILO DI RIPORTO	400			
	PSPI 410	PROFILO SOTTOZOCLOLO	330			
	PSPI 411	RIDUTTORE	270			
	PSPI 412	TRAVERSO	1.018			
	PSPI 413	FERMAVETRO	281			
	PSPI 414	PROFILO COMPENSATORE	550			
	PSPI 415	IMBOTTE PORTA SCORREVOLE 46 mm	848			
	PSPI 416	IMBOTTE PORTA SCORREVOLE 56 mm	923			
	PSPI 417	RIDUTTORE ARROTONDATO	389			

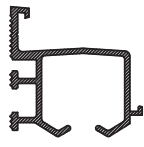
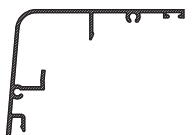

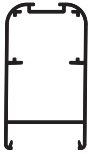
 PROFILO	CODICE	DESCRIZIONE	 gr/ml	Sup.0x	Jx cm ⁴	Jy cm ⁴
	PSPI 418	GUIDA CARRELLO SUPERIORE	1.080			
	PSPI 419	CARTER SUPERIORE	856			
	PSPI 420	PROFILATO COMPENSATORE MURO	219			
	PSPI 421	PROFILO SOTTOTELAIO PORTA SPAZZOLINO	375			
	PSPI 422	ANTA MAGGIORATA DA 90 mm	1.229			



PERSEA[®]
SISTEMI PORTE INTERNE



CODICE:
PSPI 401

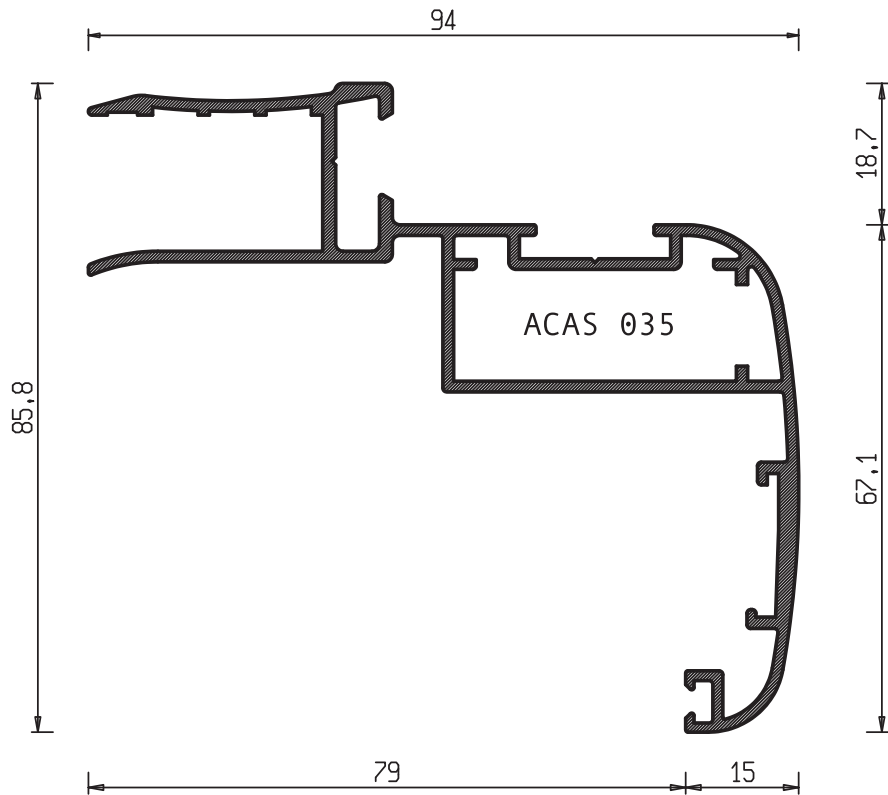

PESO gr/ml:
1.380

CODICE:
PSPI 402

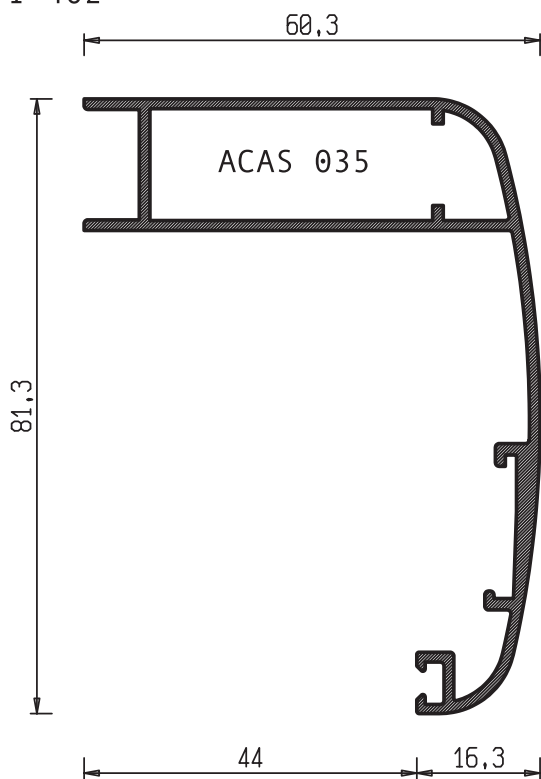

PESO gr/ml:
760

CODICE:
PSPI 407

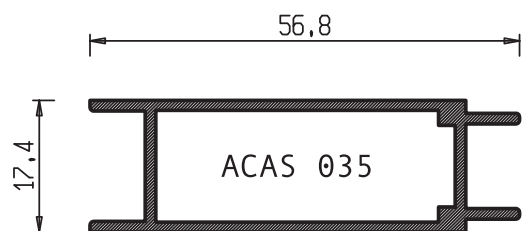

PESO gr/ml:
490



CODICE:
PSPI 404

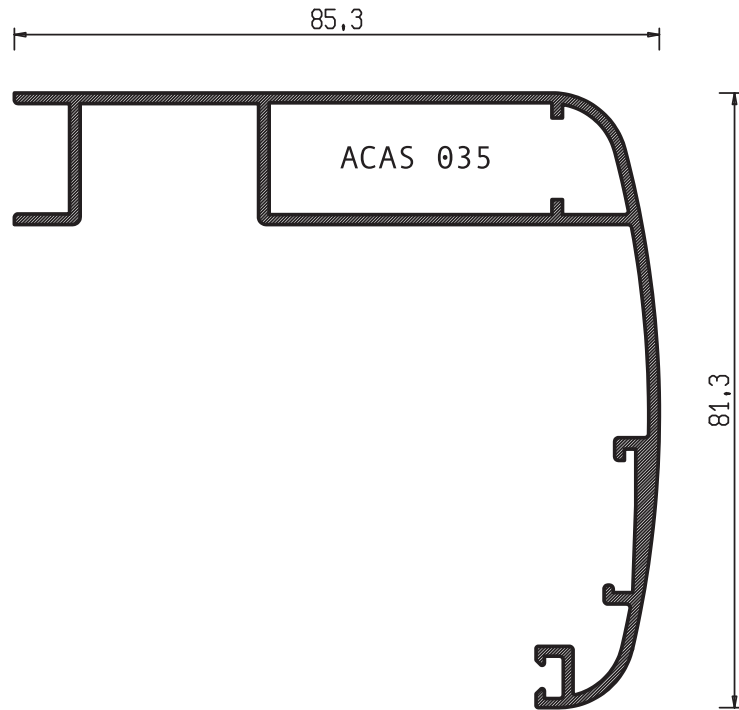

PESO gr/ml:
1.075

CODICE:
PSPI 403

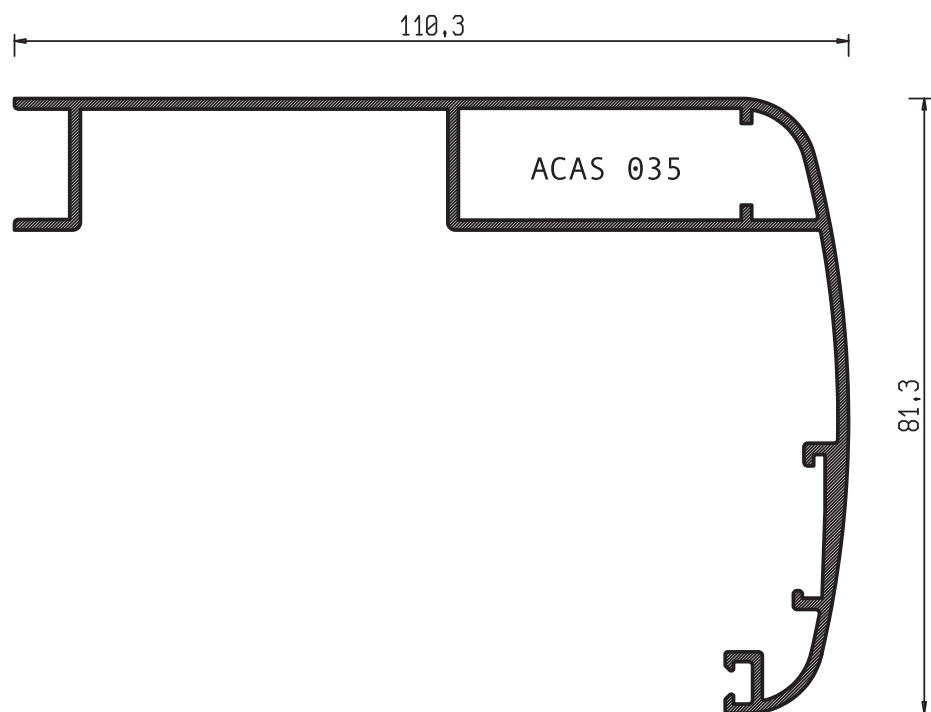

PESO gr/ml:
1.169



DETTAGLIO PROFILI

CODICE:
PSPI 405

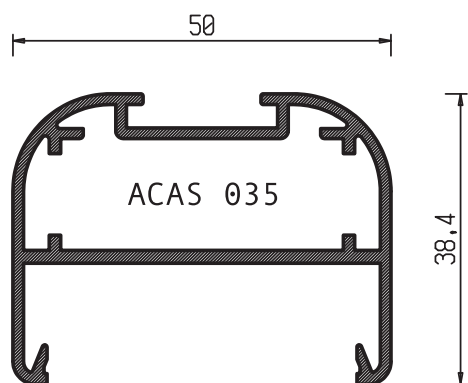

PESO gr/ml:
730

CODICE:
PSPI 406

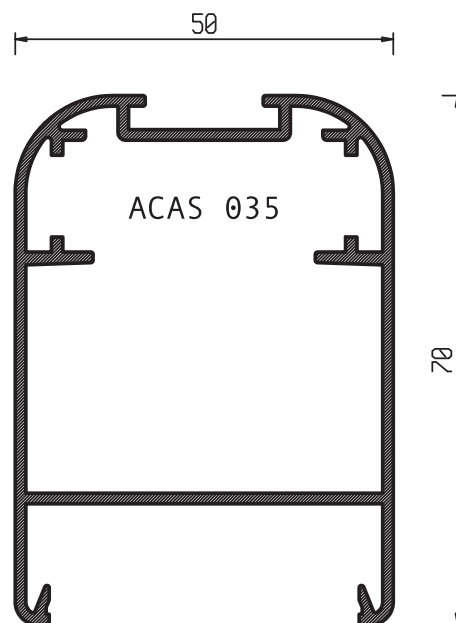

PESO gr/ml:
980

CODICE:
PSPI 409

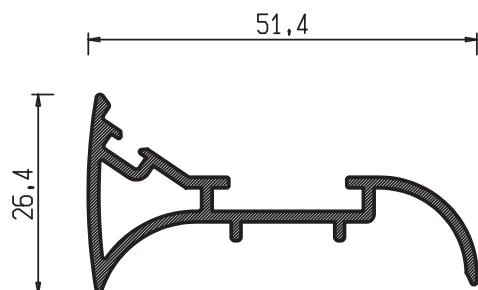

PESO gr/ml:
400

CODICE:
PSPI 408

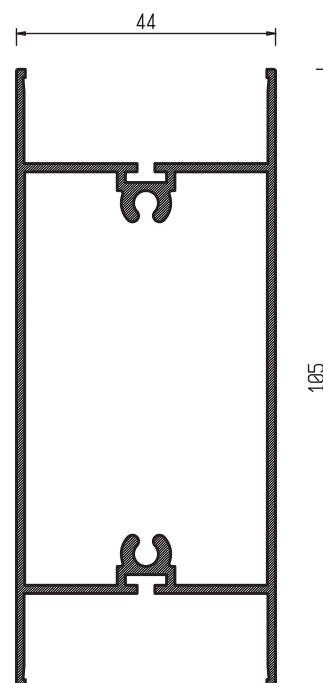

PESO gr/ml:
1.260



DETTAGLIO PROFILI

CODICE:
PSPI 410

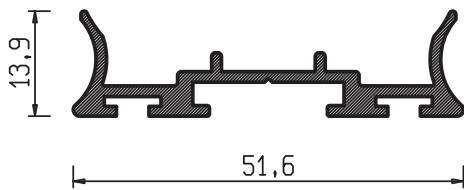

PESO gr/ml:
330

CODICE:
PSPI 411

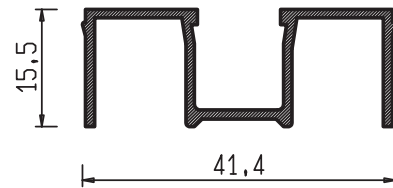

PESO gr/ml:
270

CODICE:
PSPI 412

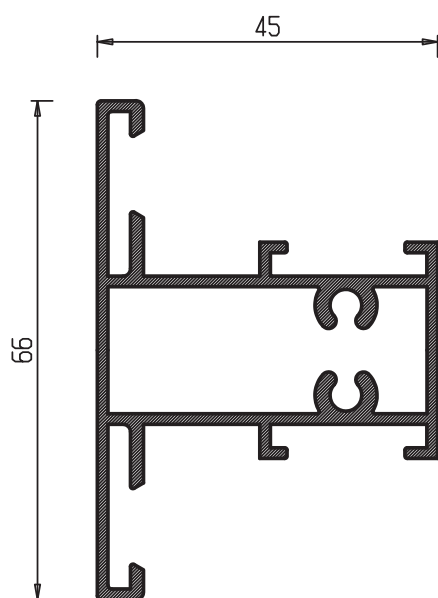

PESO gr/ml:
1.018

CODICE:
PSPI 413

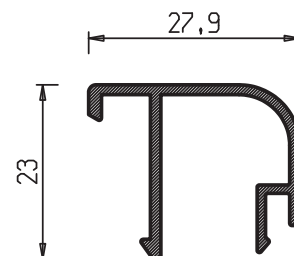

PESO gr/ml:
281



DETTAGLIO PROFILI

CODICE:
PSPI 414

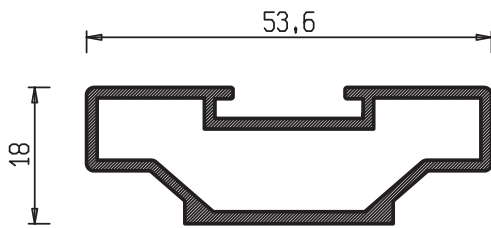

PESO gr/ml:
550

CODICE:
PSPI 415

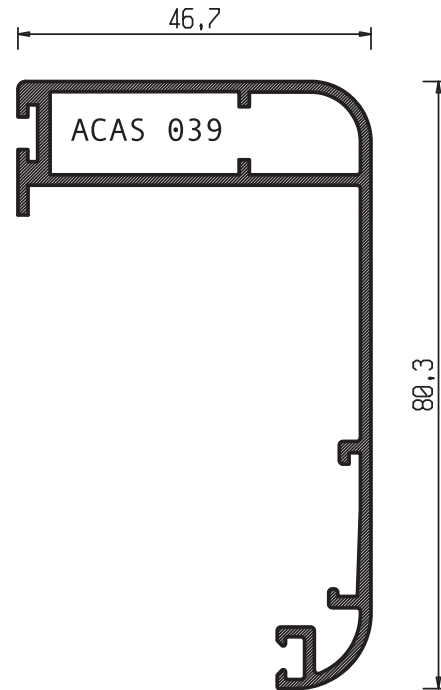

PESO gr/ml:
848

CODICE:
PSPI 416

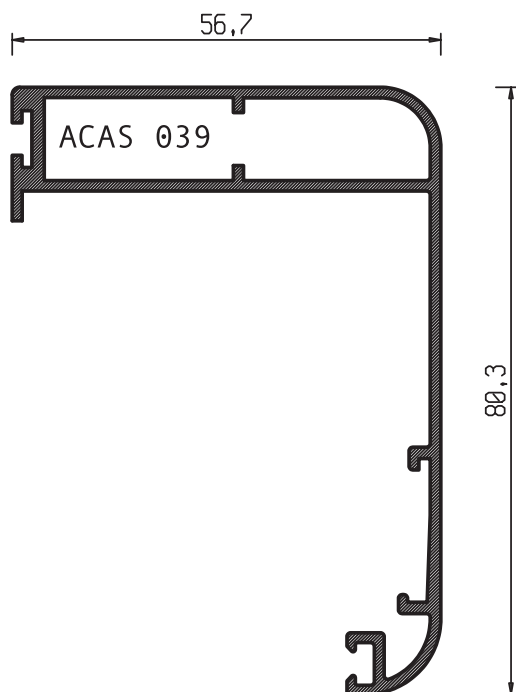

PESO gr/ml:
923

CODICE:
PSPI 417

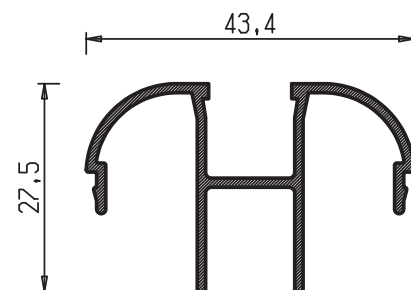

PESO gr/ml:
389



DETTAGLIO PROFILI

CODICE:
PSPI 418

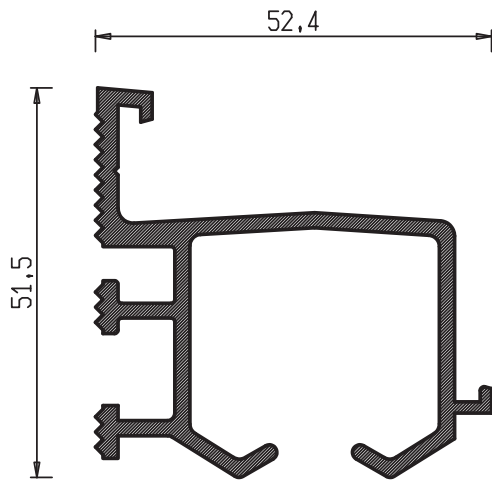

PESO gr/ml:
1080

CODICE:
PSPI 419

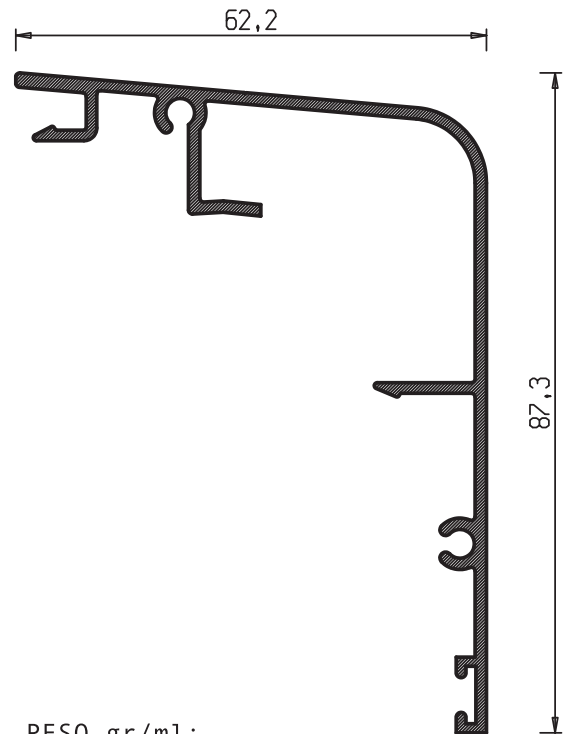

PESO gr/ml:
856

CODICE:
PSPI 420

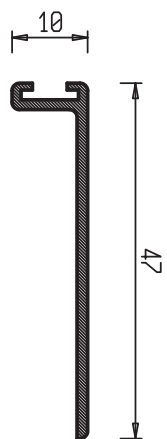

PESO gr/ml:
219

CODICE:
PSPI 421

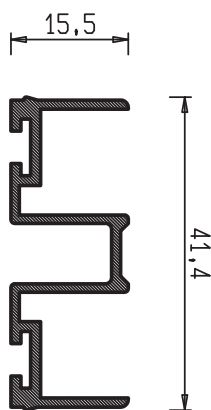

PESO gr/ml:
375

CODICE:
PSPI 422

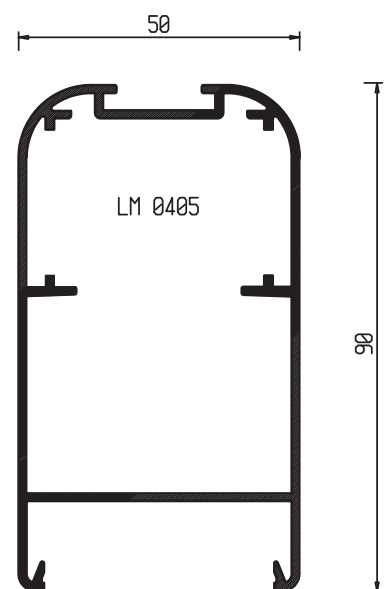

PESO gr/ml:
1.229

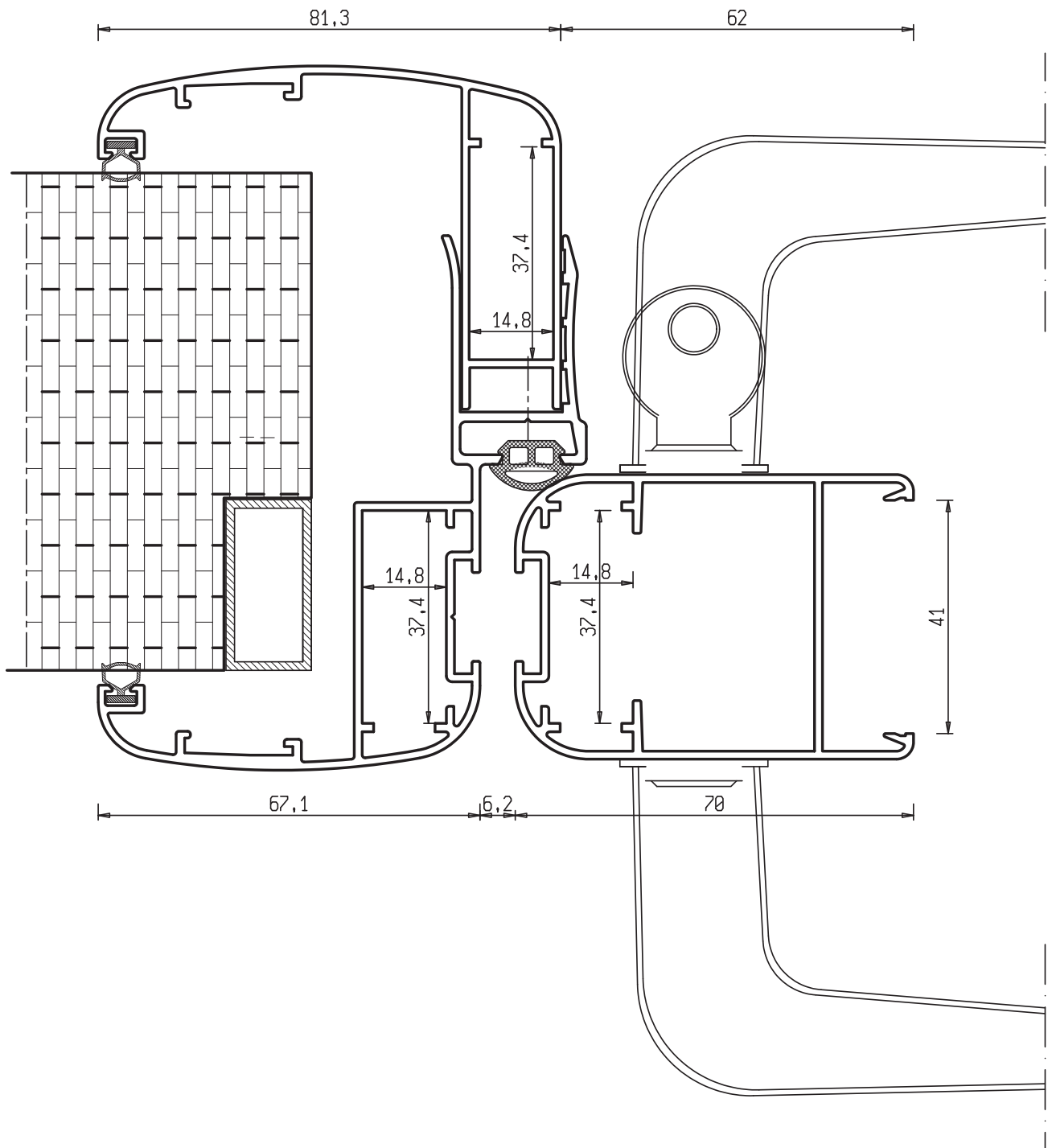

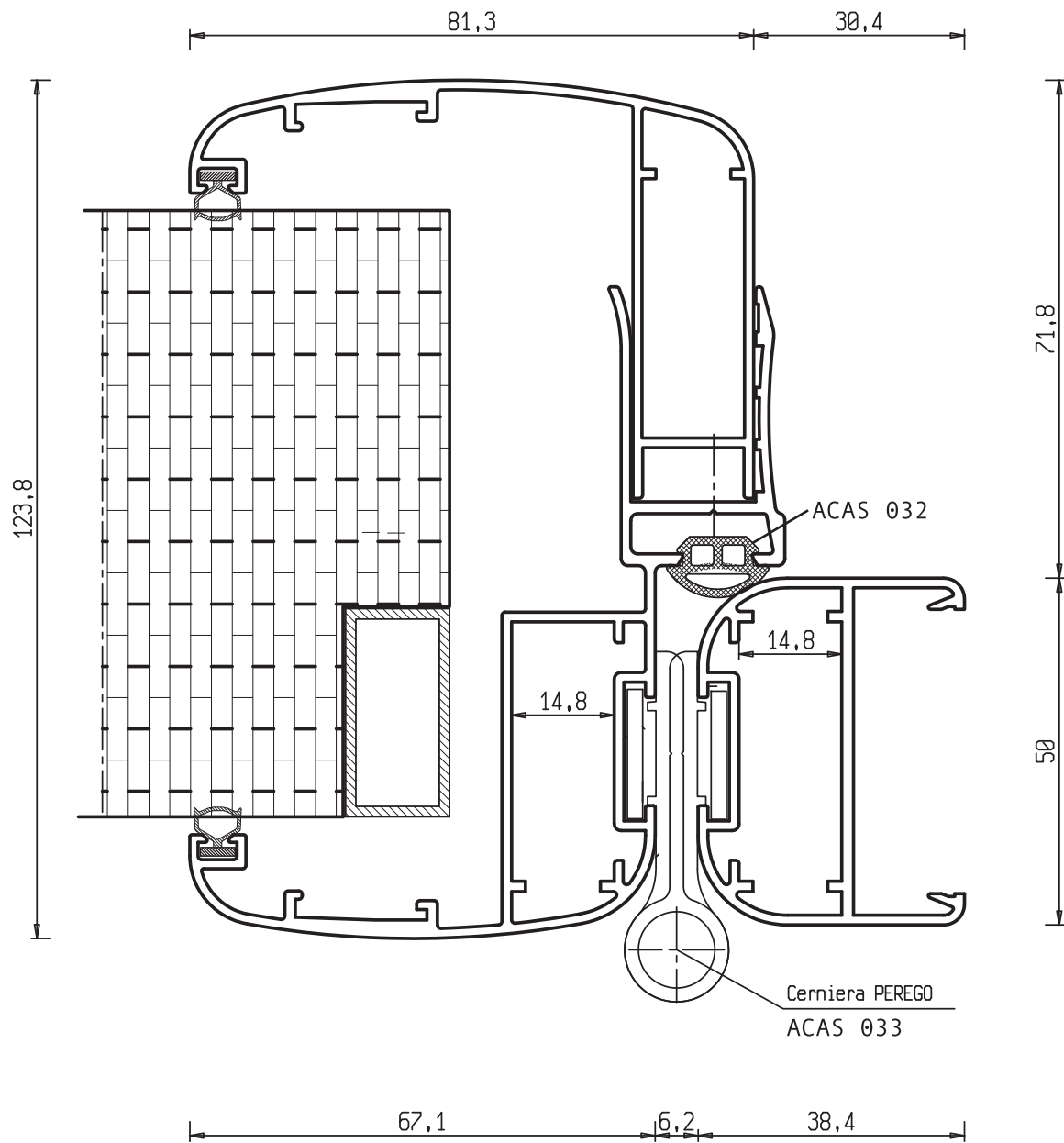

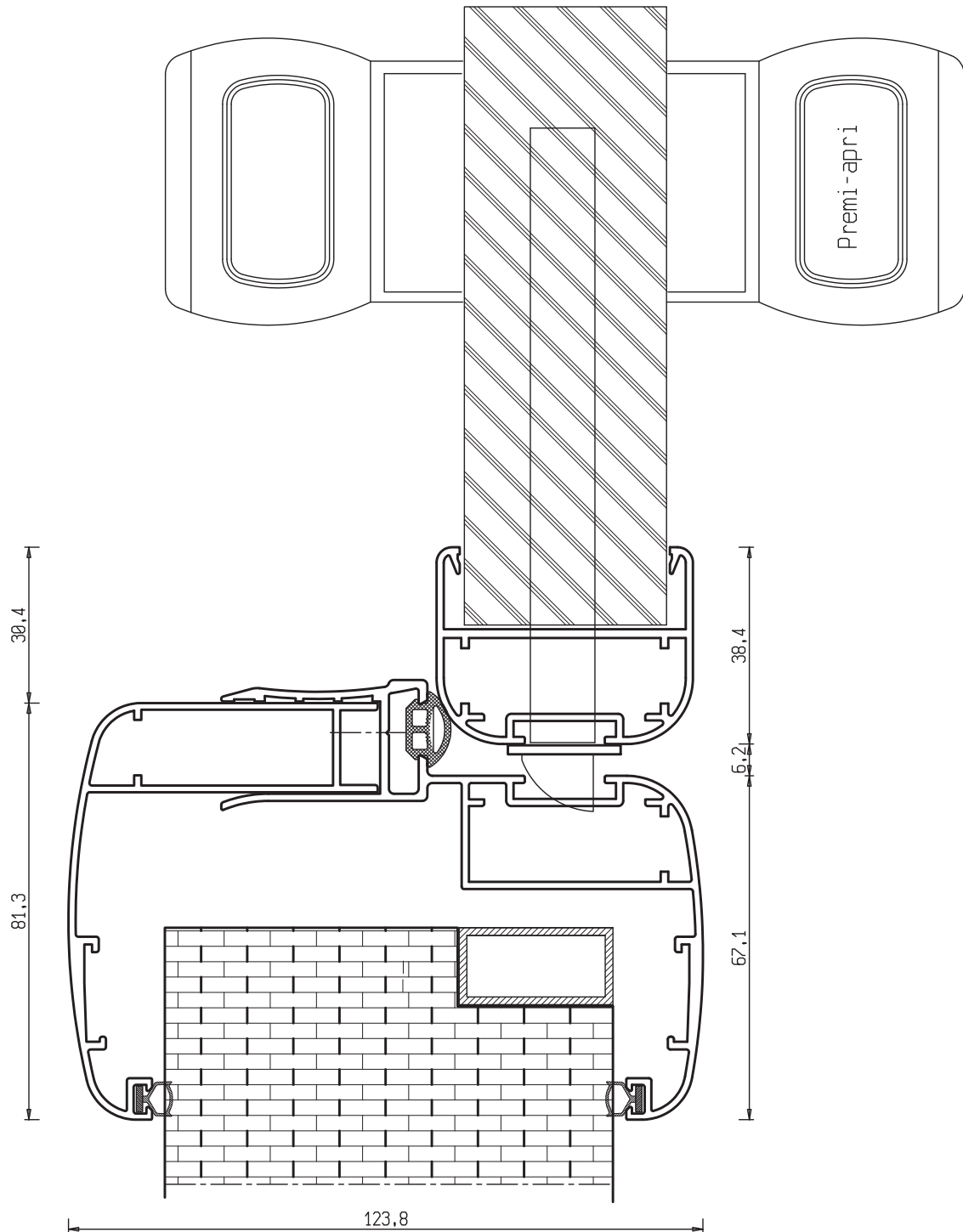

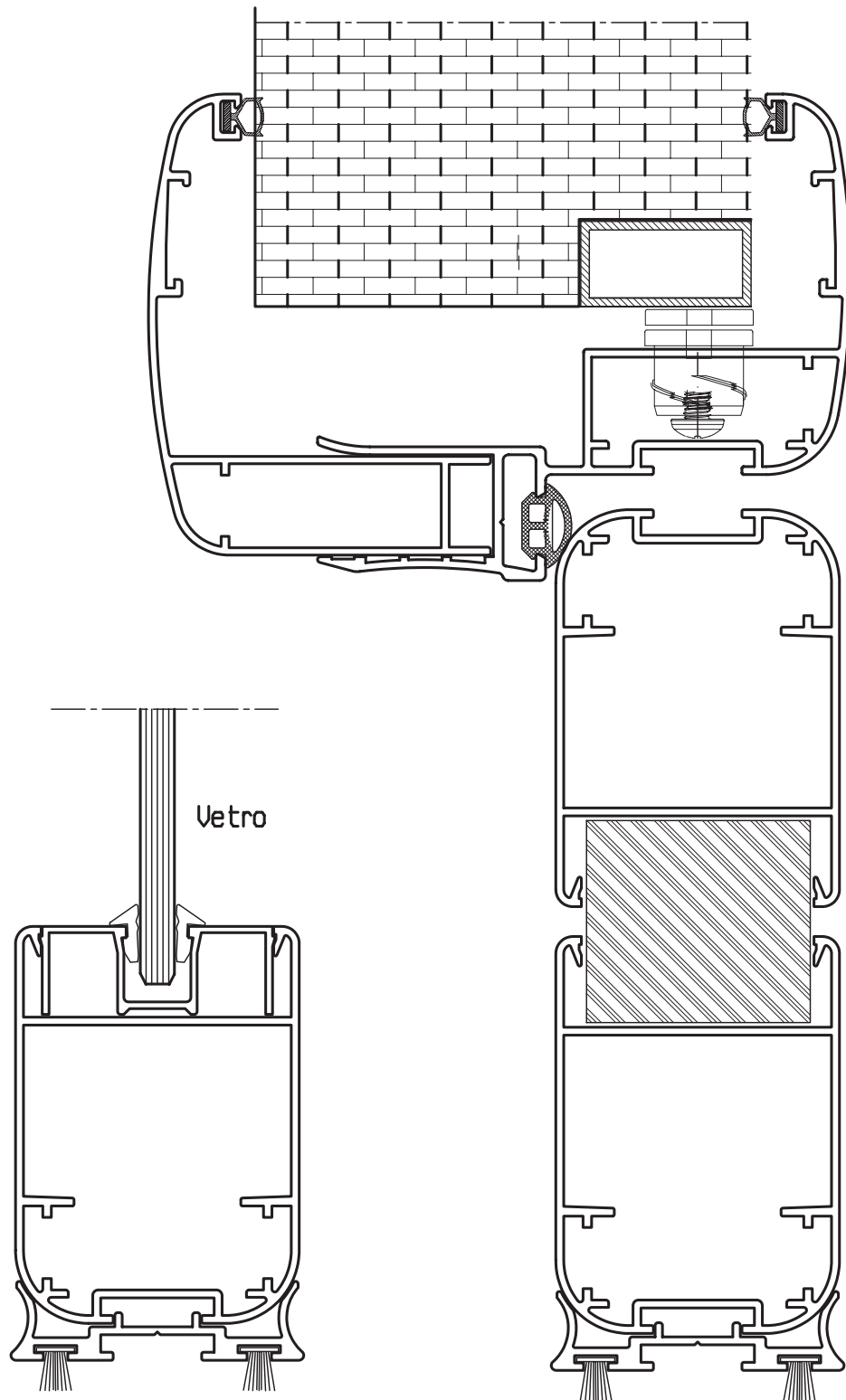

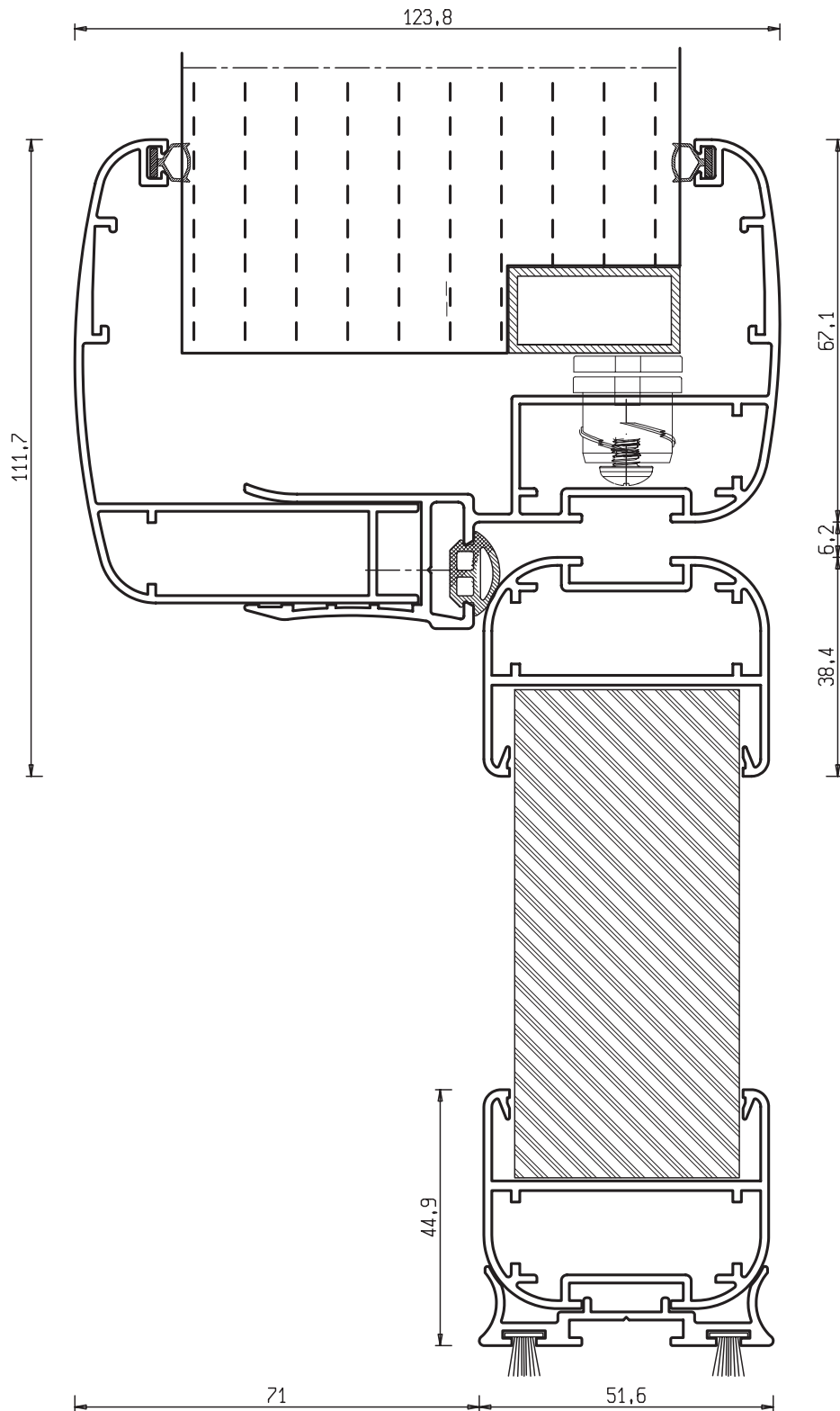



Quadratura fissa

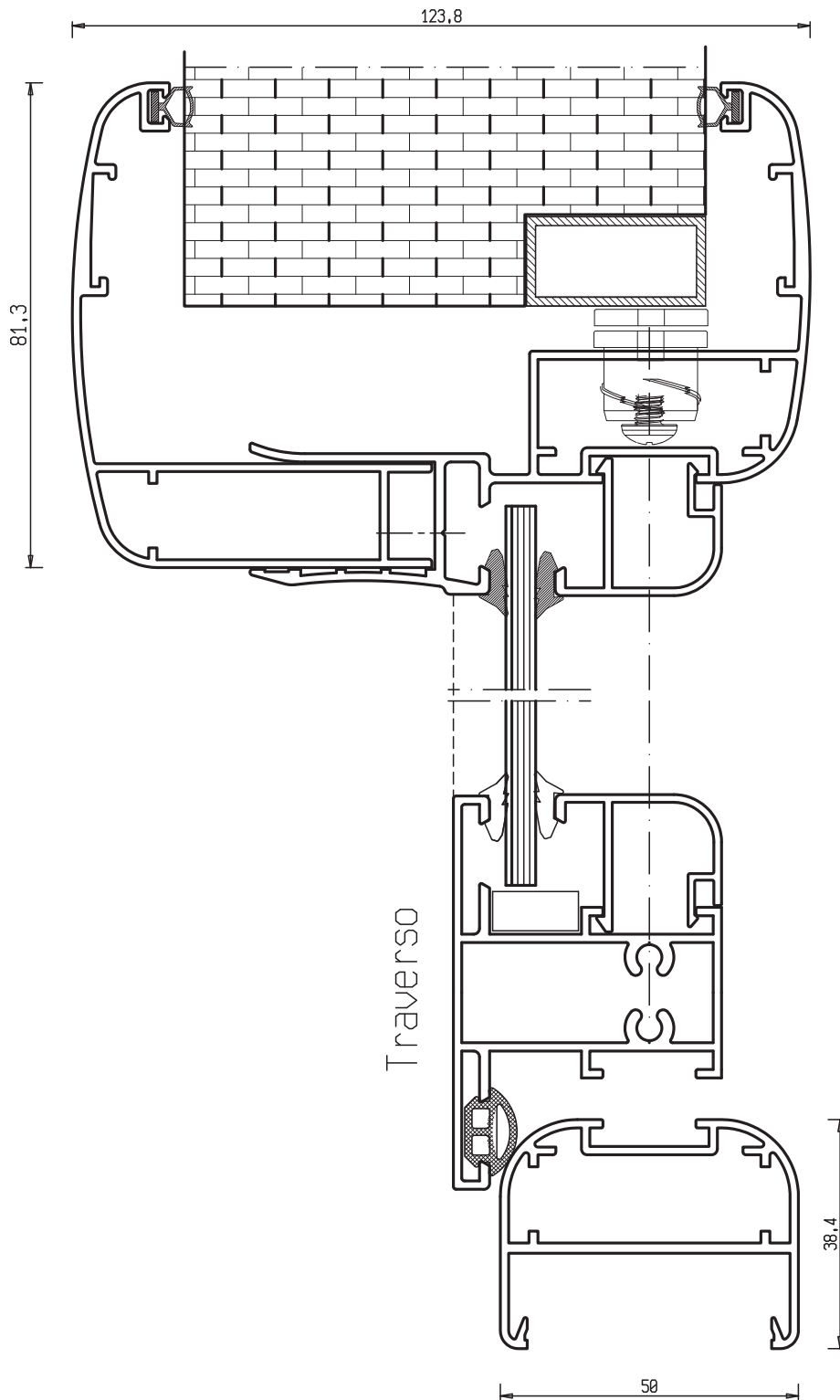

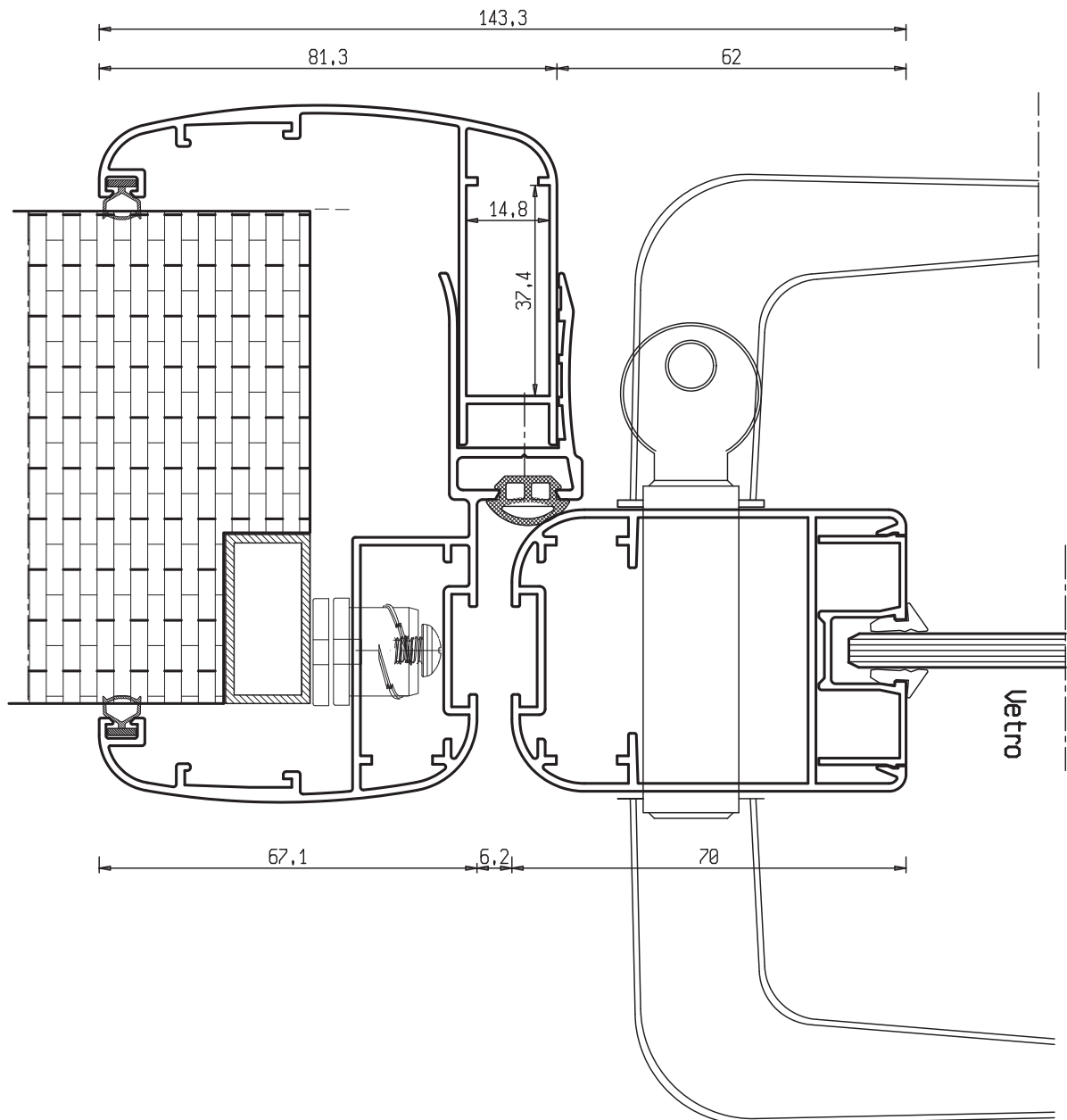

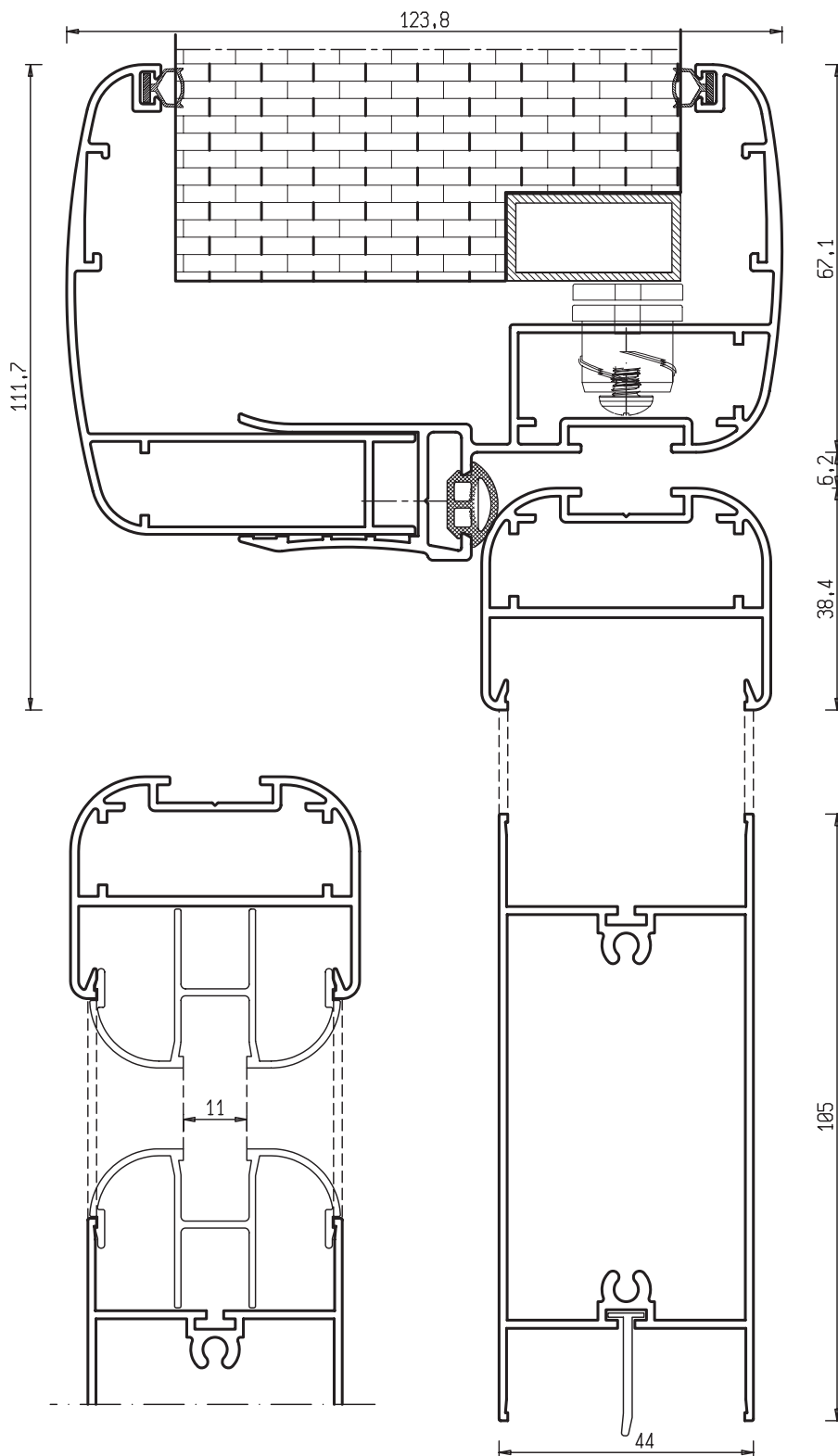

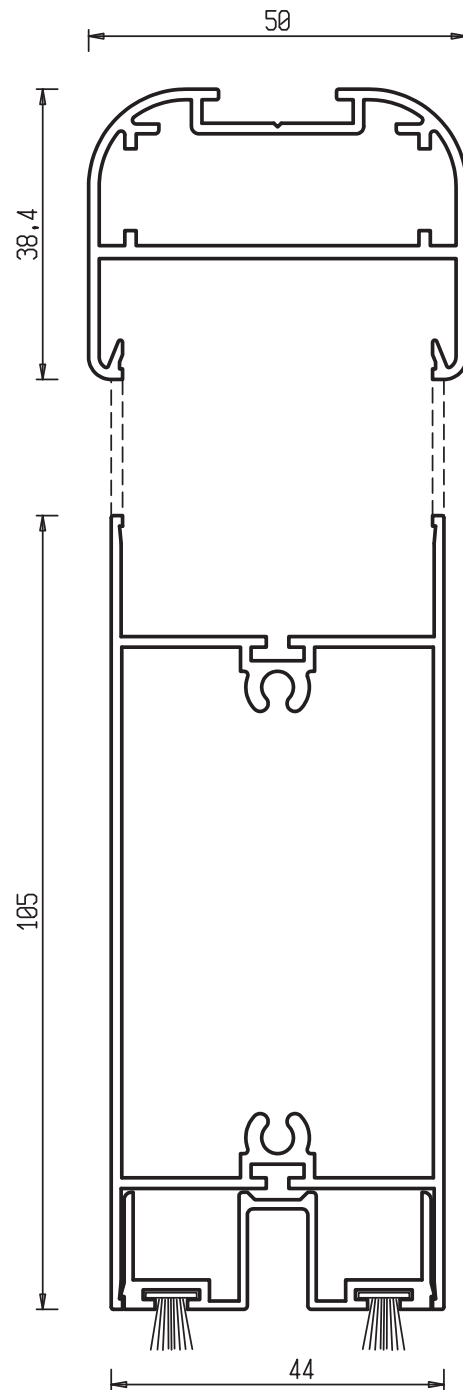

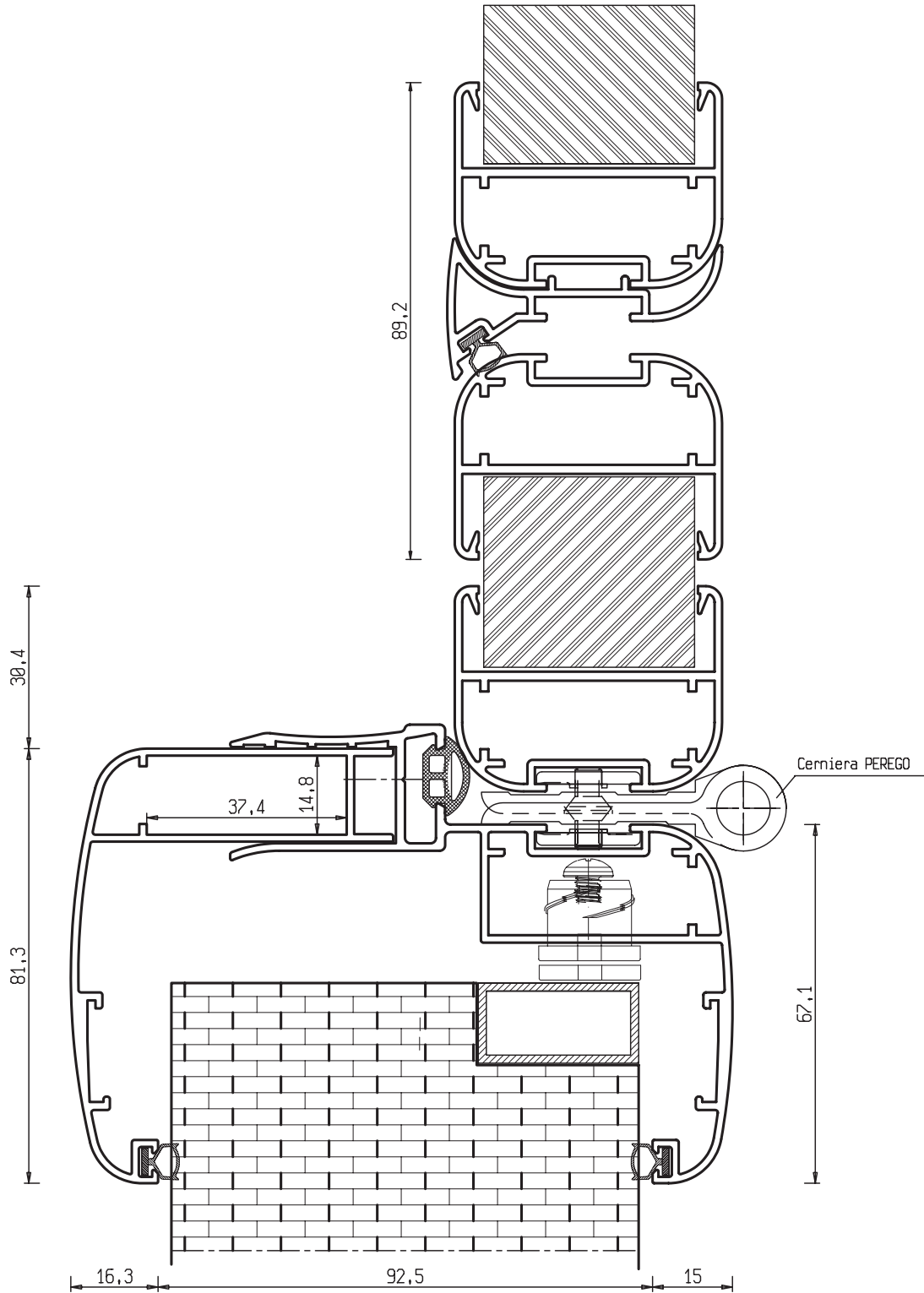

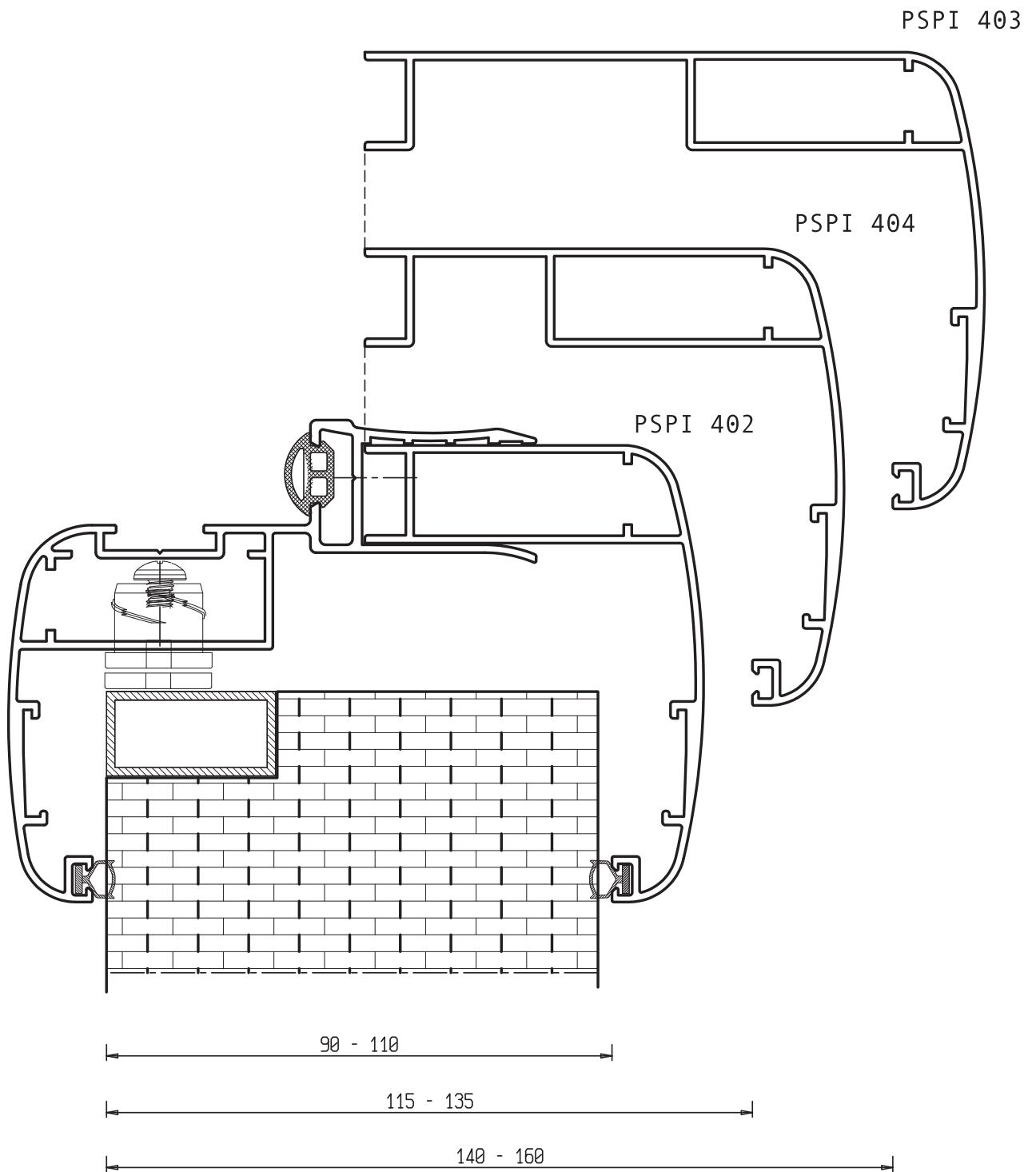

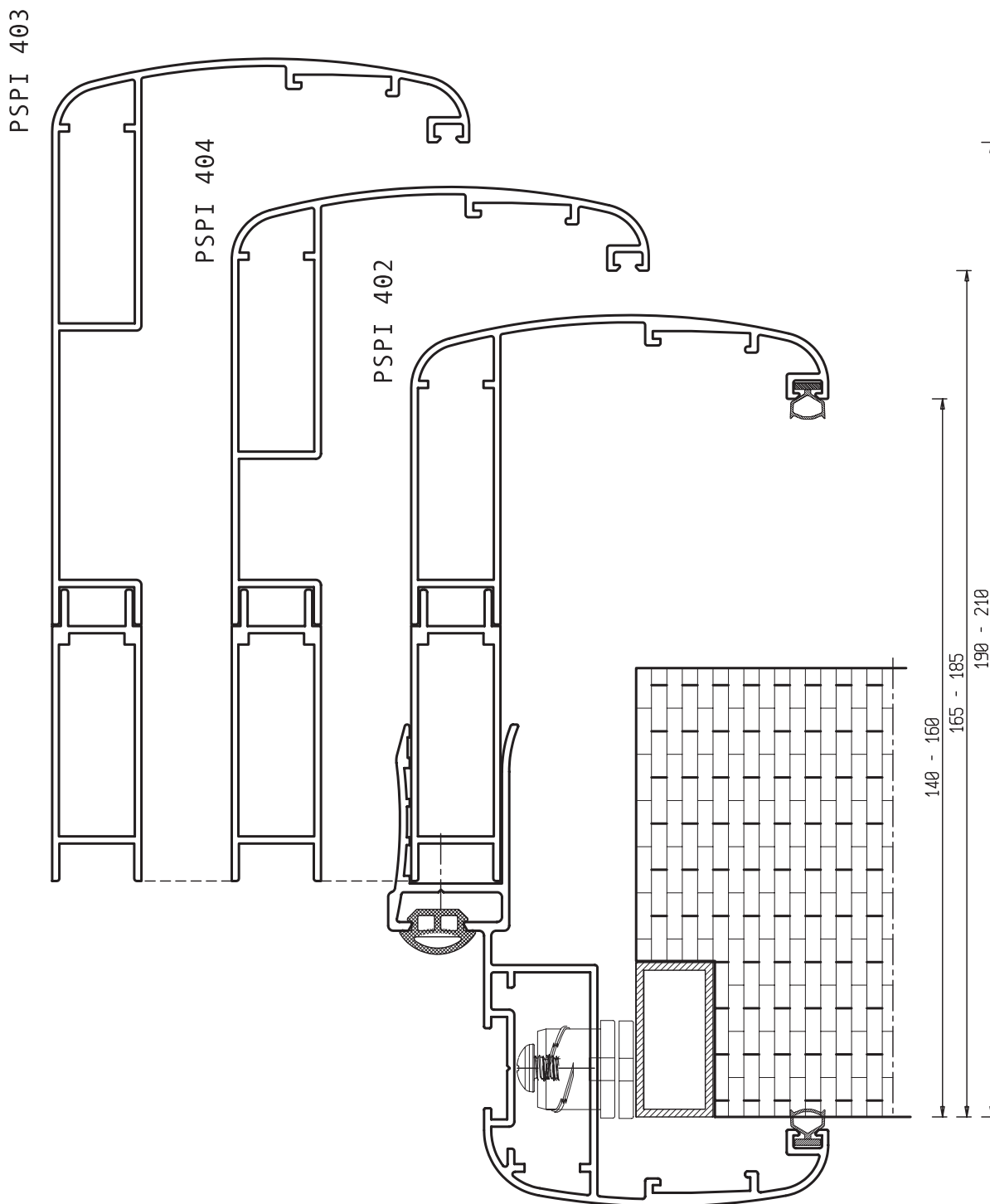

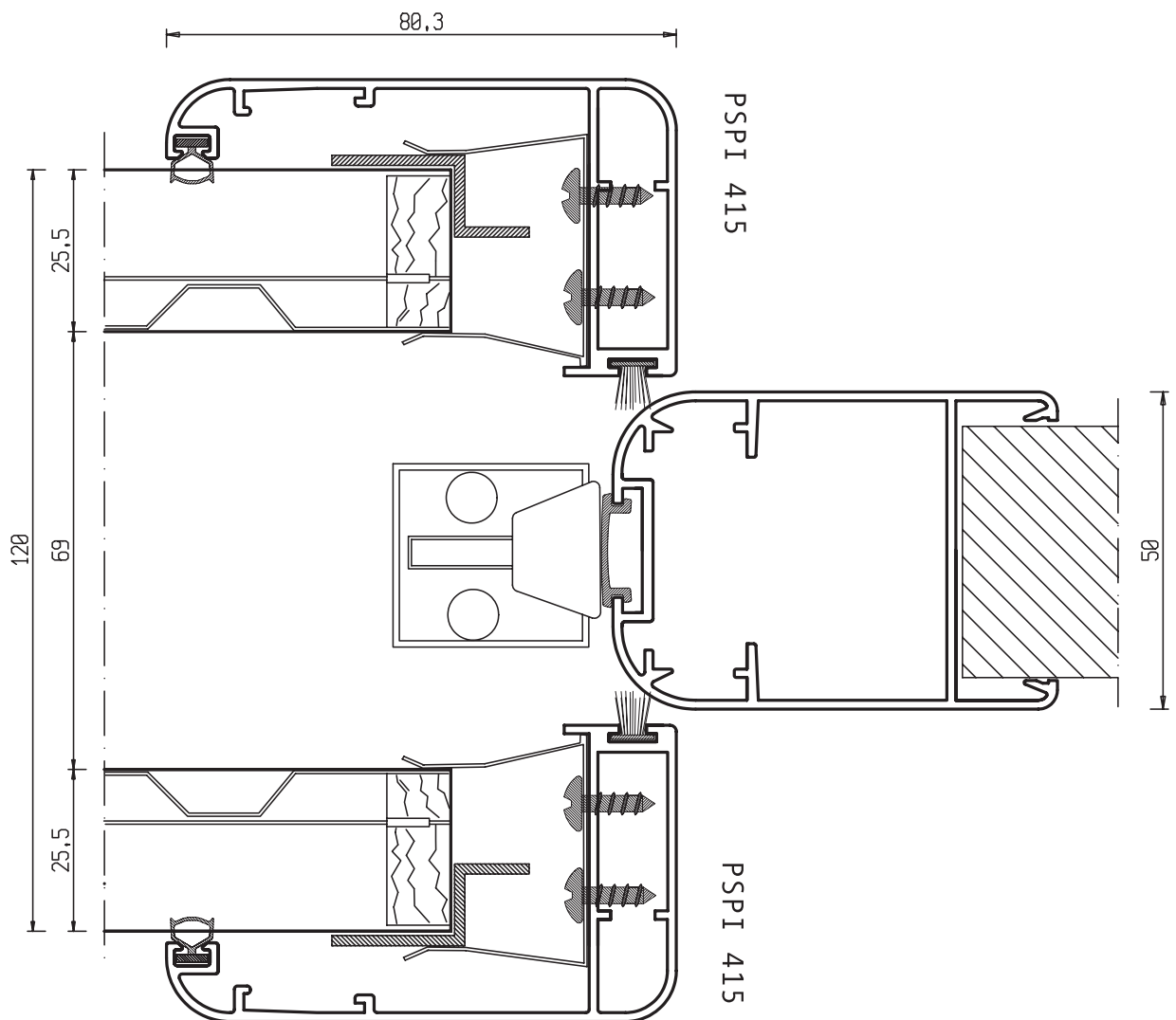

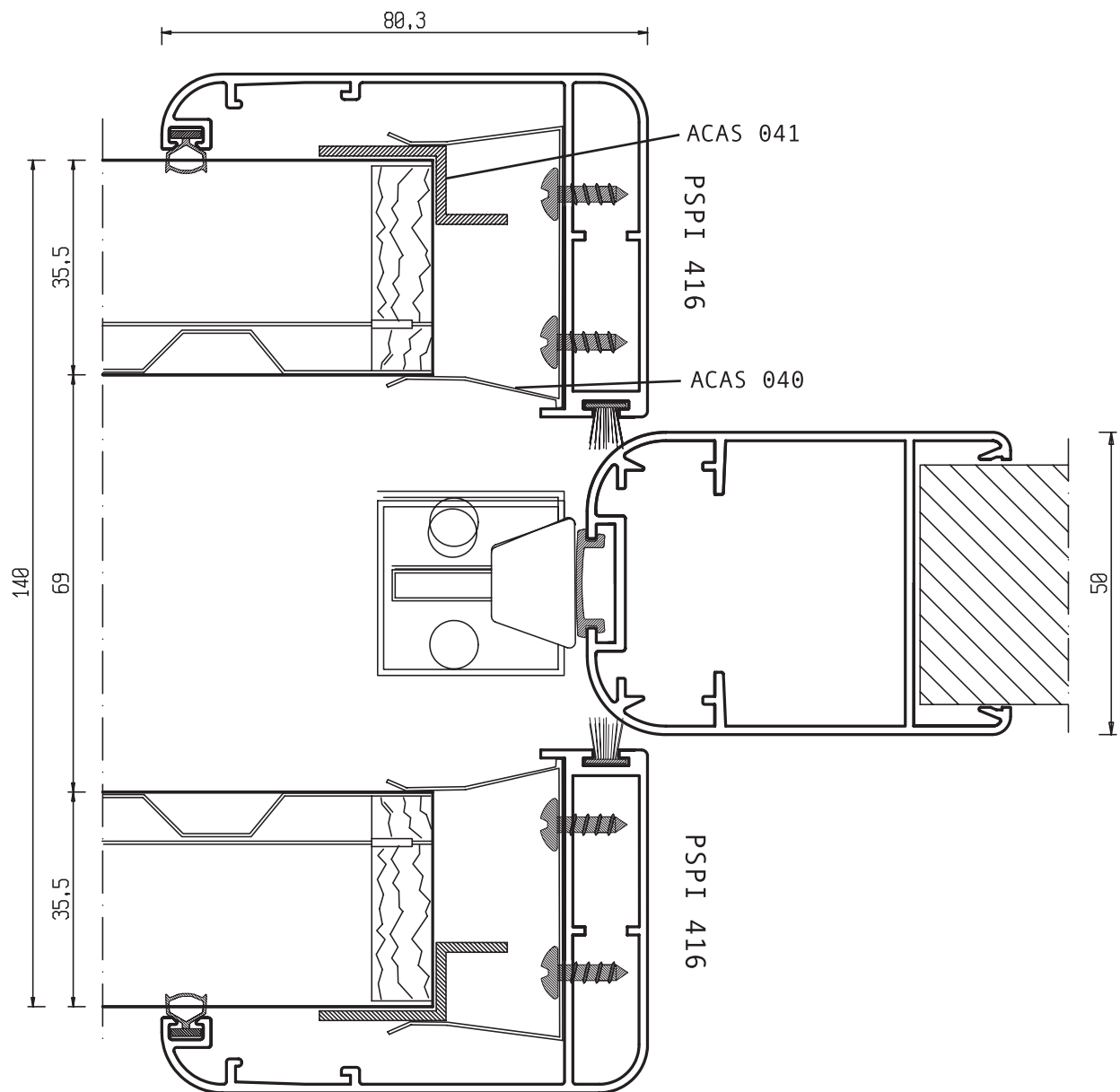

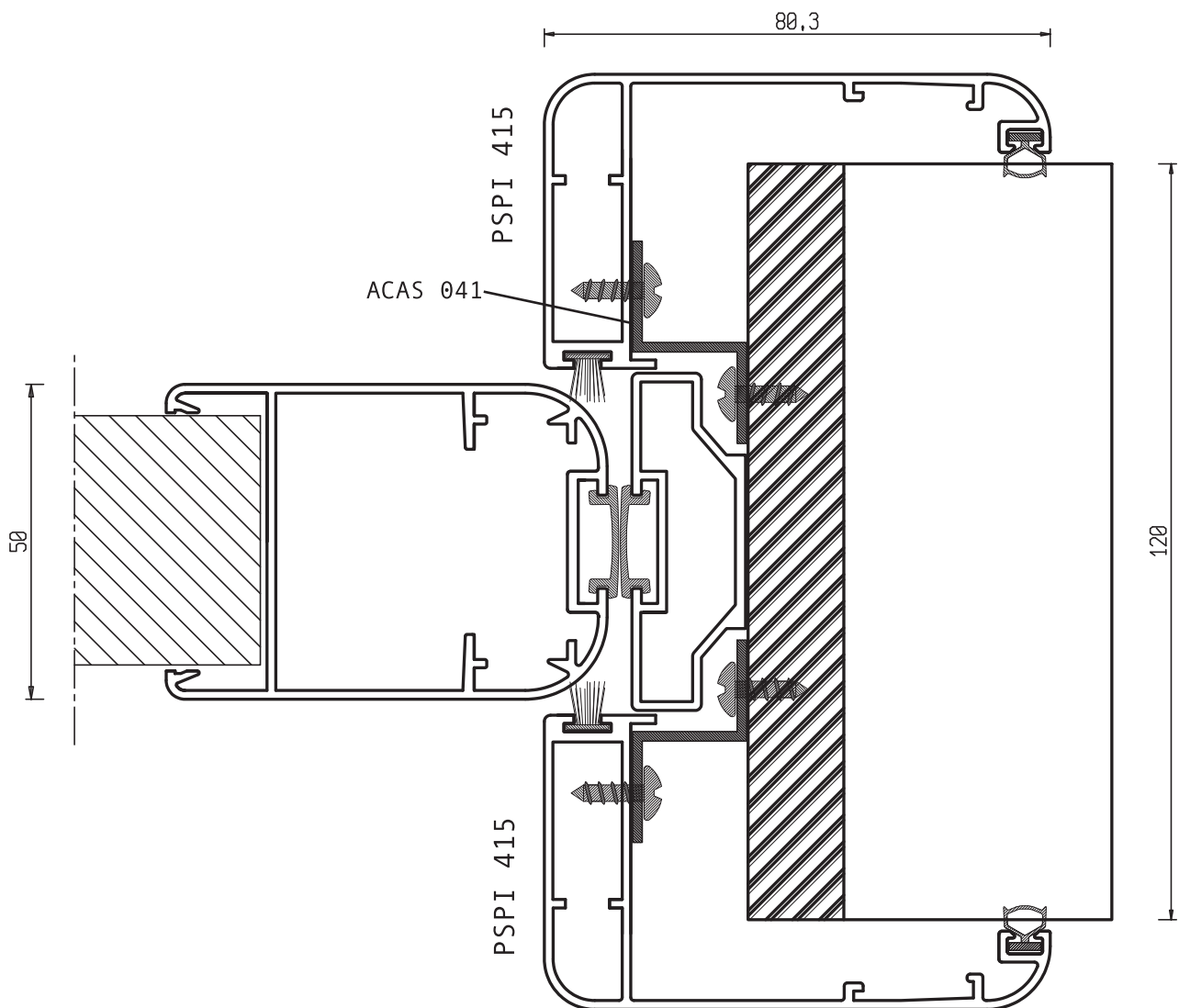

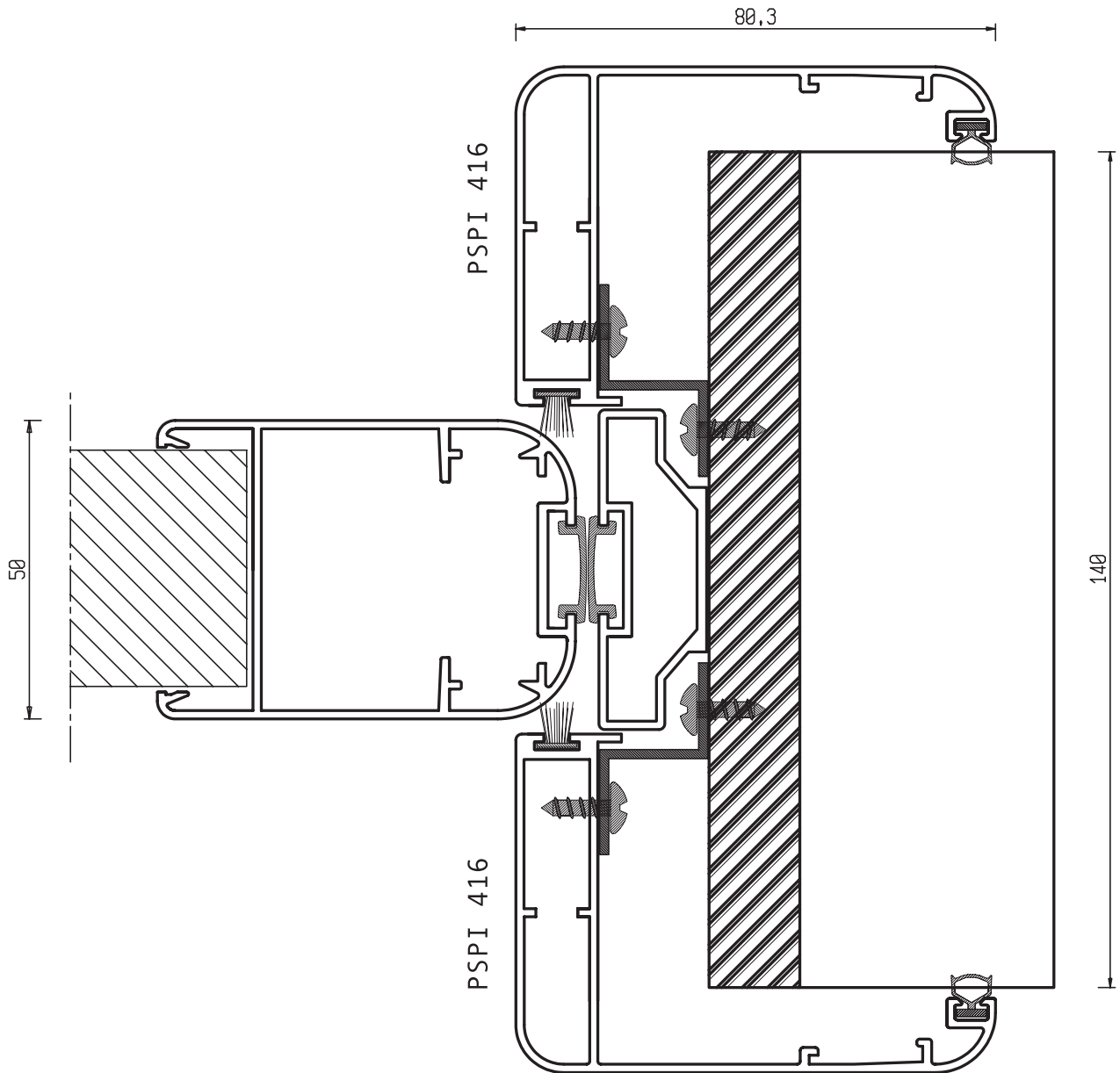

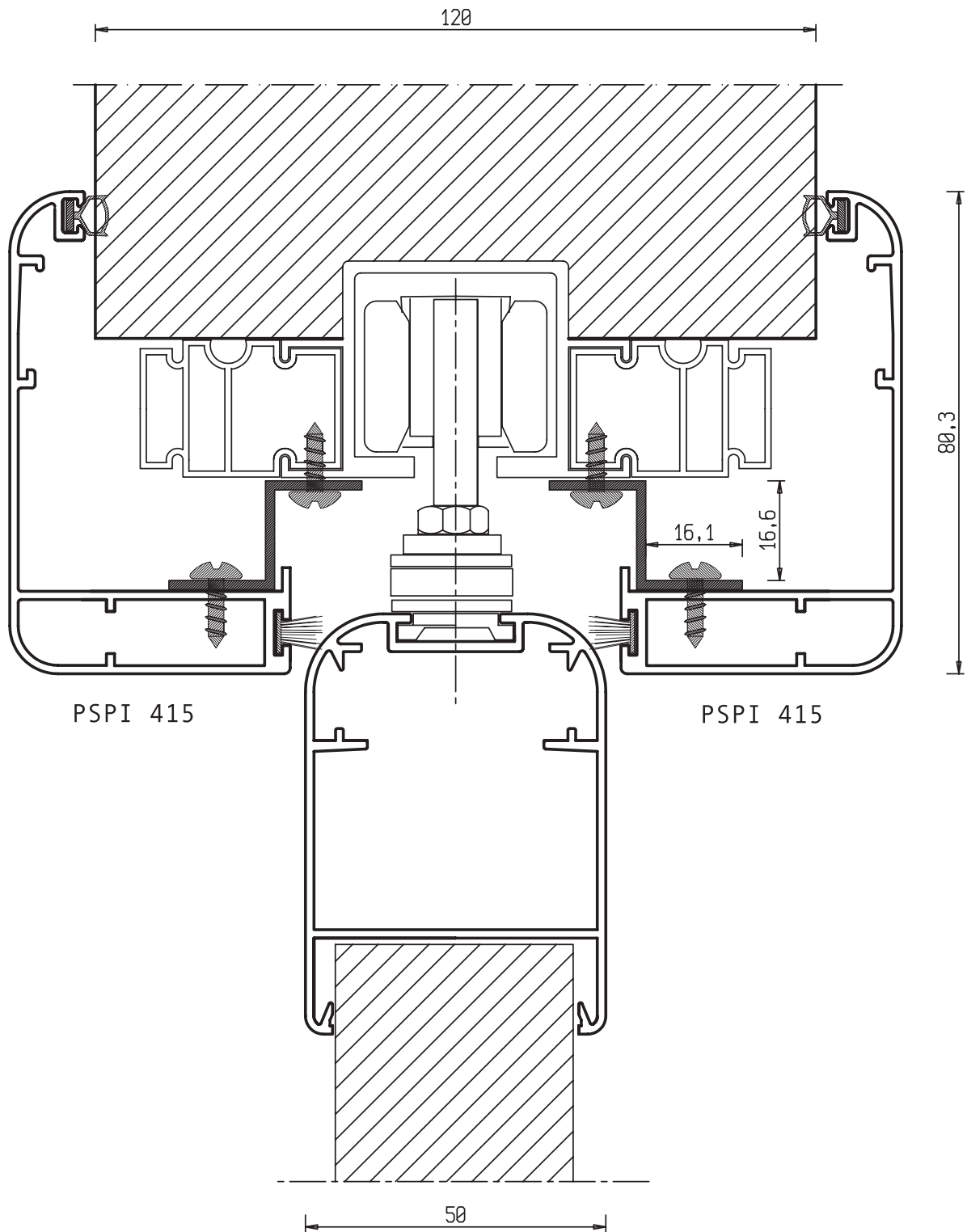

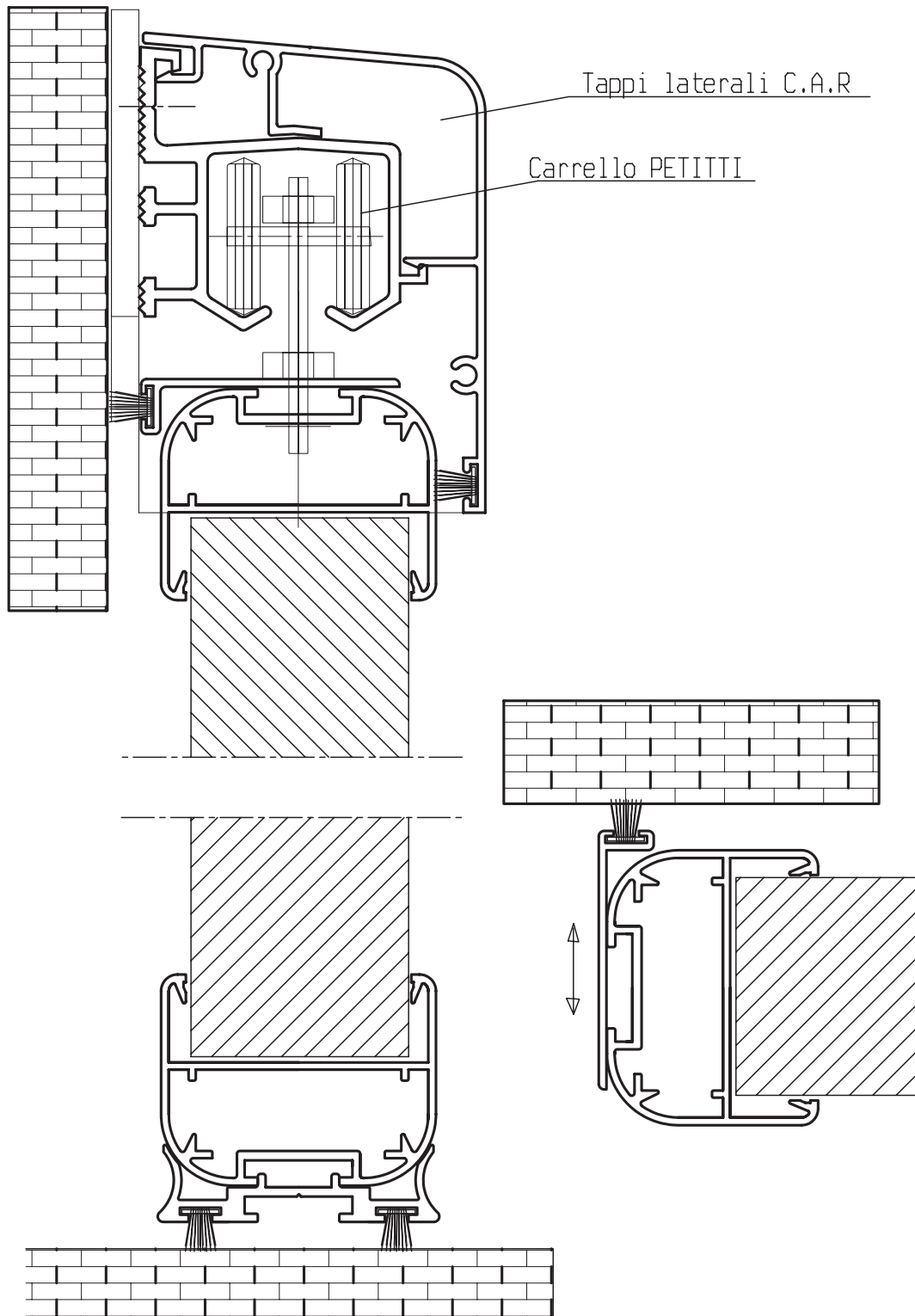

Lista di taglio porta a 1 anta

Profilo	Descrizione	Pezzi Oriz.	Pezzi Vert.	Misure Oriz.	Misure Vert.
PSP1401	Telaio	1	2	Lt+75	Ht+37.5
PSP1402	Imbotte	1	2	Lt+75	Ht+37.5
PSP1405	Anta	1	2	Lt-72	Ht-41
PSP1408	Fascia	1		Lt-116	

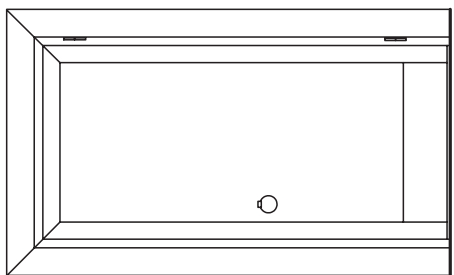
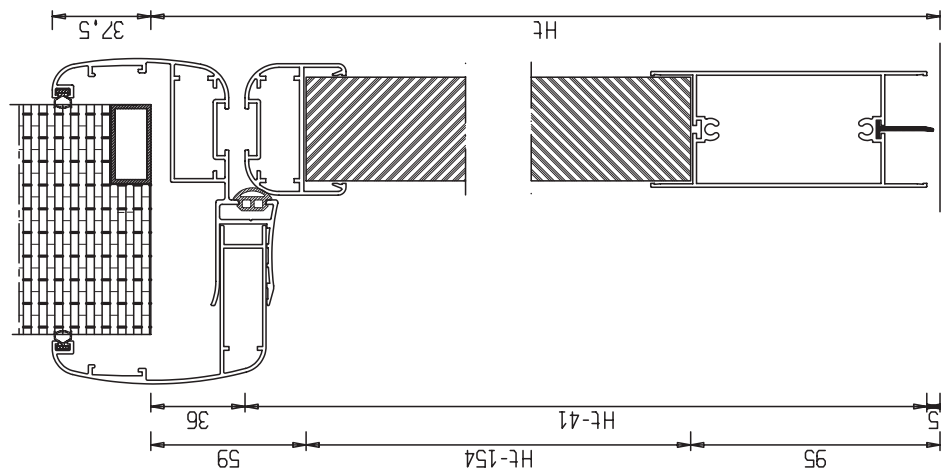

Pannello
Lv = Lt-118
Hv = Ht-154

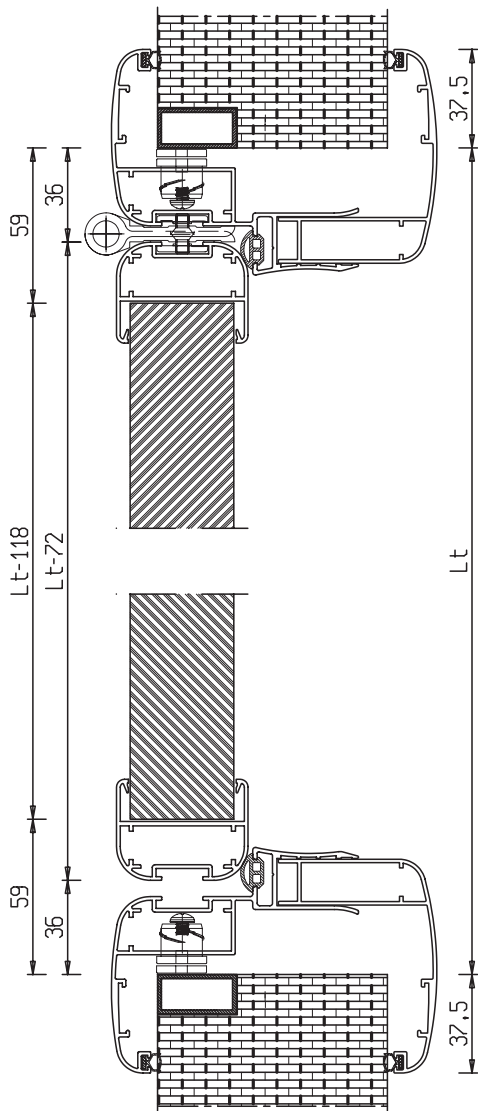

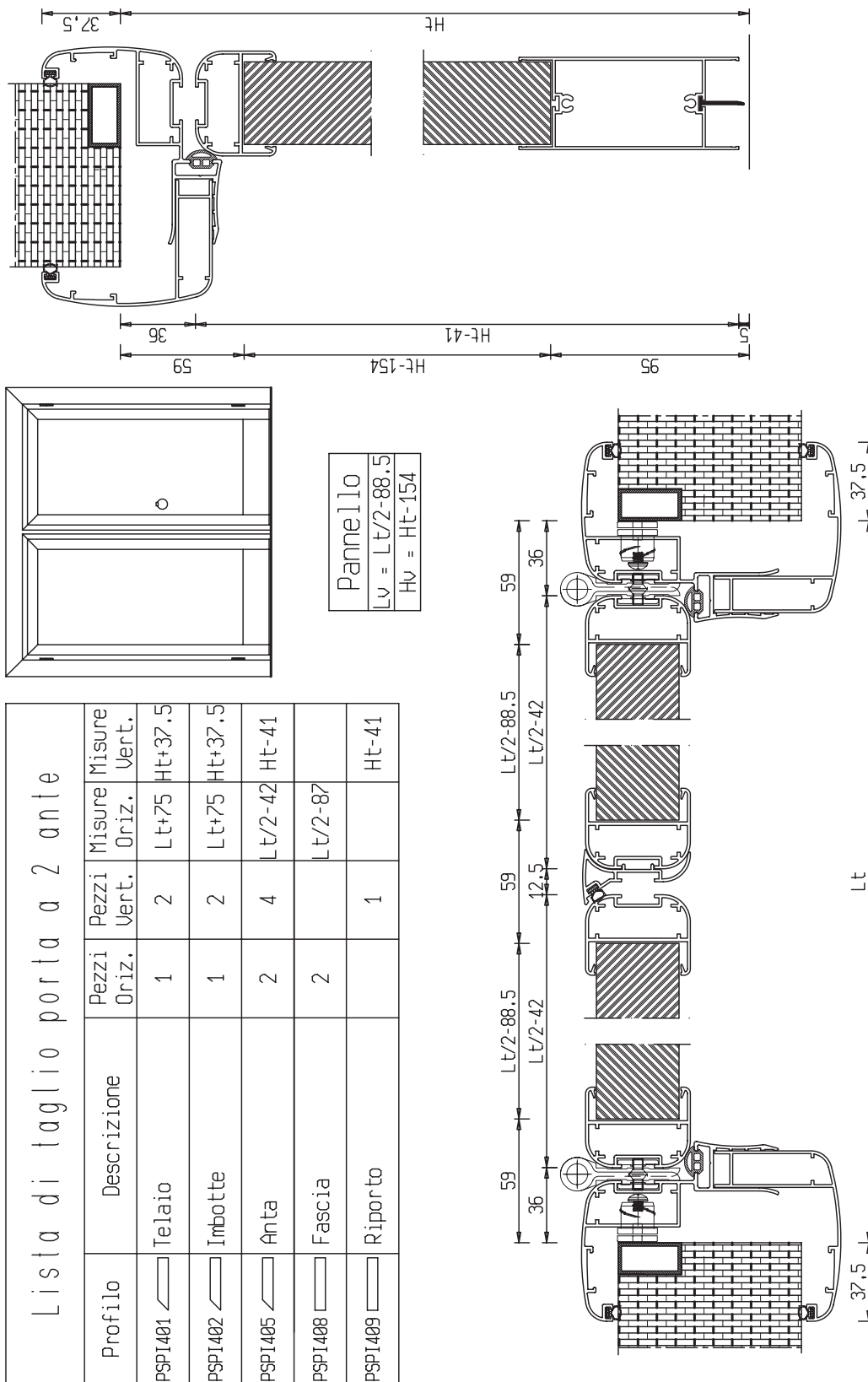

Pannello
Lv = Lt/2-88,5
Hv = Ht-154

Lista di taglio porta a 2 ante

Profilo	Descrizione	Pezzi Oriz.	Pezzi Vert.	Misure Oriz.	Misure Vert.
PSP1401	Telaio	1	2	Lt+75	Ht+37,5
PSP1402	Imbotte	1	2	Lt+75	Ht+37,5
PSP1405	Anta	2	4	Lt/2-42	Ht-41
PSP1408	Fascia	2		Lt/2-87	
PSP1409	Riporto		1		Ht-41



Lista di taglio porta a 1 anta

Profilo	Descrizione	Pezzi Oriz.	Pezzi Vert.	Misure Oriz.	Misure Vert.
PSP1401	Telaio	1	2	Lt+75	-
PSP1402	Imbotte	1	2	Lt+75	-
PSP1405	Anta	1	2	Lt-72	-
PSP1408	Fascia	1		Lt-116	
PSP1412	Traverso	1		Lt-59	
PSP1413	Fermavetro	2	2	Lt-59	-

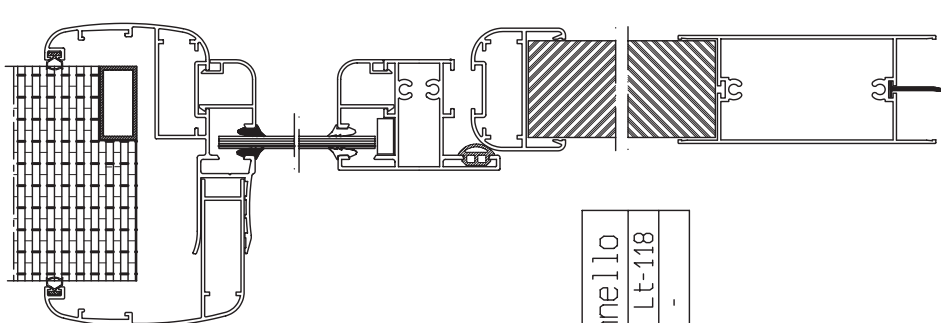
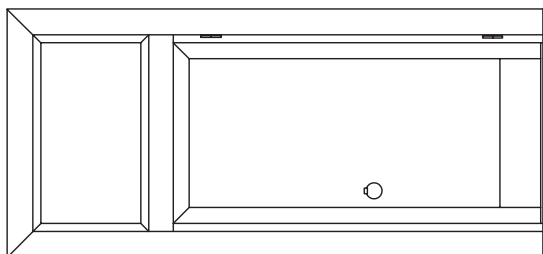

Pannello	-
Lv = Lt-118	-

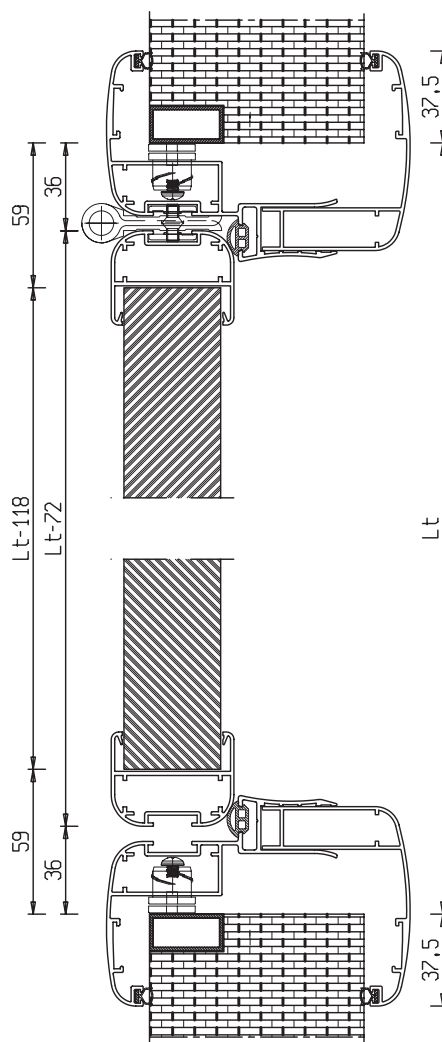

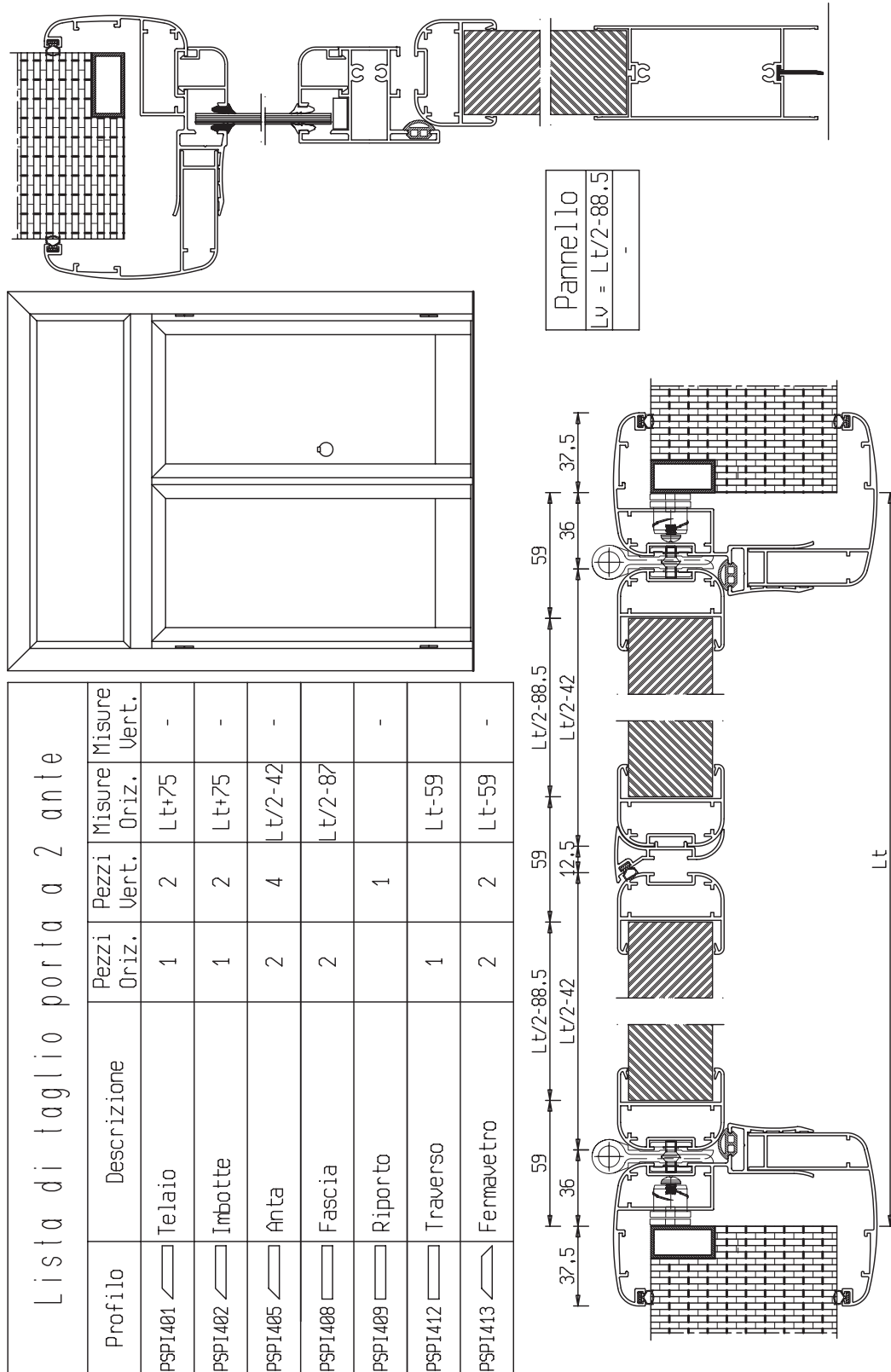



Lista di taglio porta a 1 anta

Profilo	Descrizione	Pezzi Oriz.	Pezzi Vert.	Misure Oriz.	Misure Vert.
PSP1401	Telaio	1	2	Lt+75	Ht+37.5
PSP1402	Imbotte	1	2	Lt+75	Ht+37.5
PSP1405	Anta	1	2	Lt-72	Ht-41
PSP1408	Fascia	2		Lt-116	

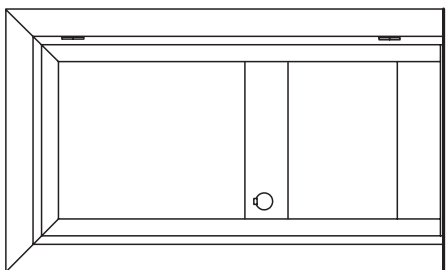

Pannello	
Lv = Lt-118	
	-

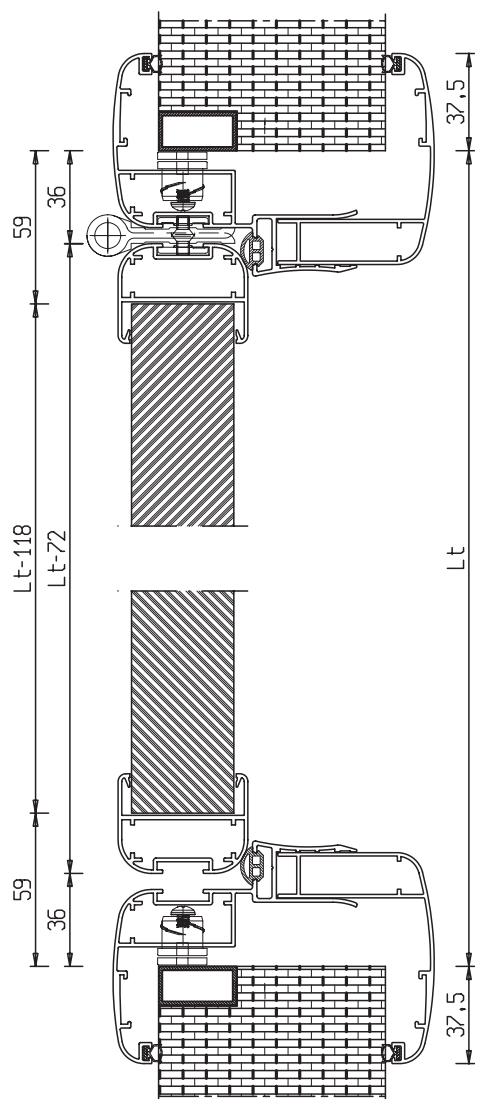
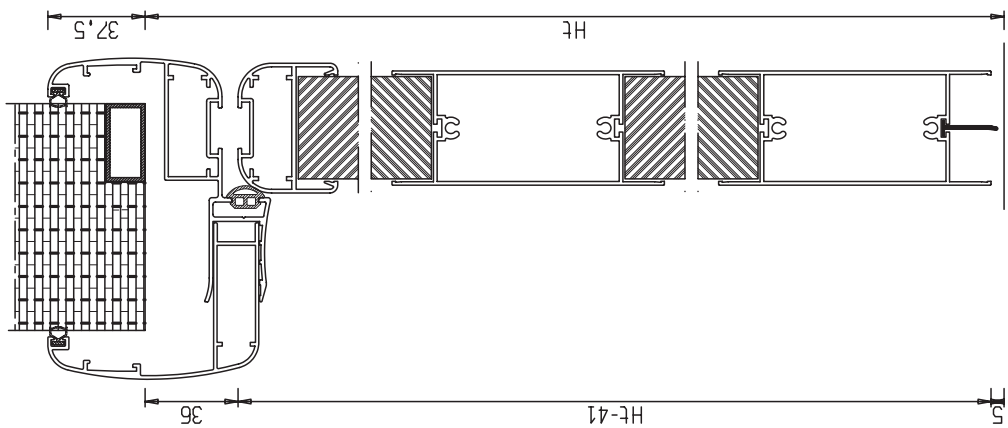

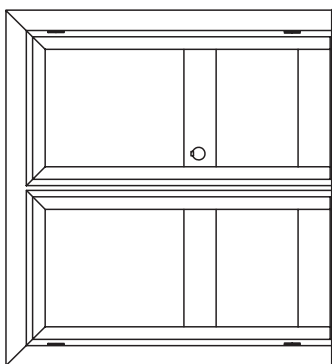
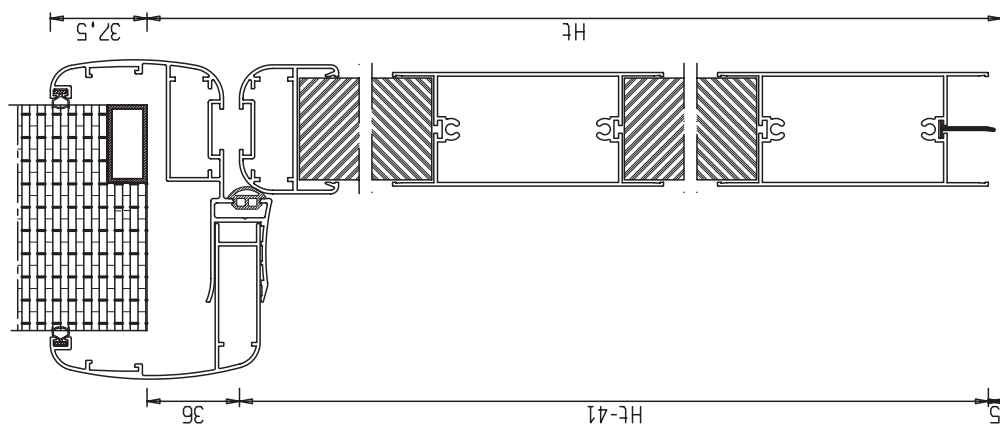

Pannello
Lv = Lt/2-88.5

Lista di taglio porta a 2 ante

Profilo	Descrizione	Pezzi Oriz.	Pezzi Vert.	Misure Oriz.	Misure Vert.
PSP1401	Telaio	1	2	Lt+75	Ht+37.5
PSP1402	Imbotte	1	2	Lt+75	Ht+37.5
PSP1405	Anta	2	4	Lt/2-42	Ht-41
PSP1408	Fascia	4		Lt/2-87	
PSP1409	Riporto		1		Ht-41

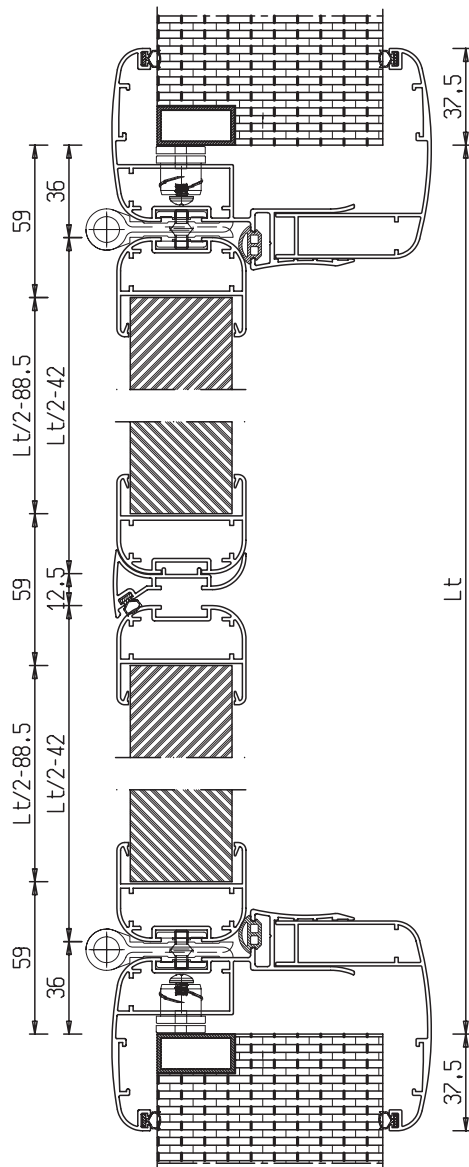



Lista di taglio porta a 1 anta

Profilo	Descrizione	Pezzi Oriz.	Pezzi Vert.	Misure Oriz.	Misure Vert.
PSP1415	Imbotte	2	4	-	-
PSP1405	Anta	2	2	-	-
PSP1408	Fascia	1	-	-	-
PSP1421	Profilo sottofascia	1	-	-	-
PSP1414	Compensatore	-	1	-	-

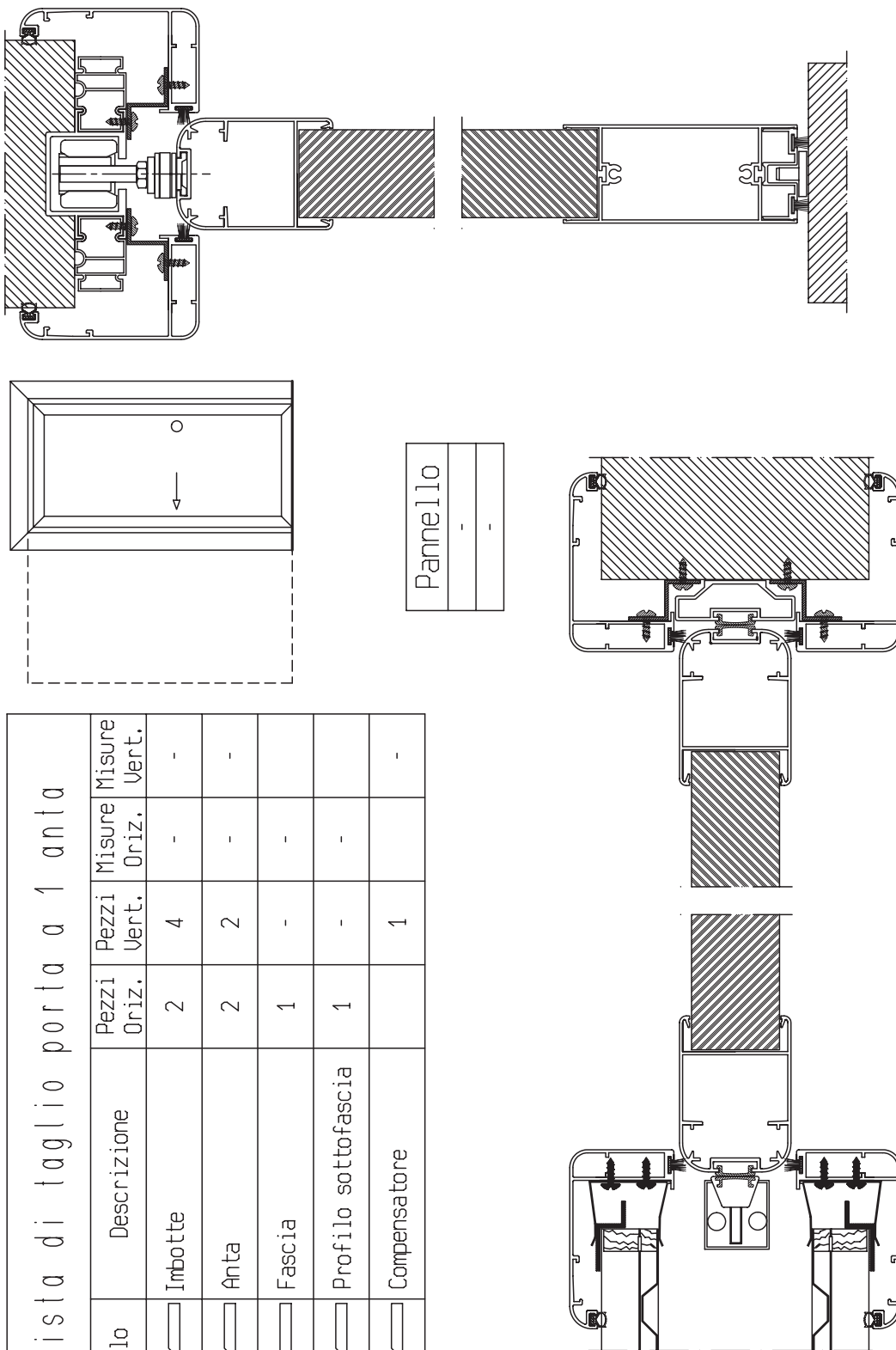

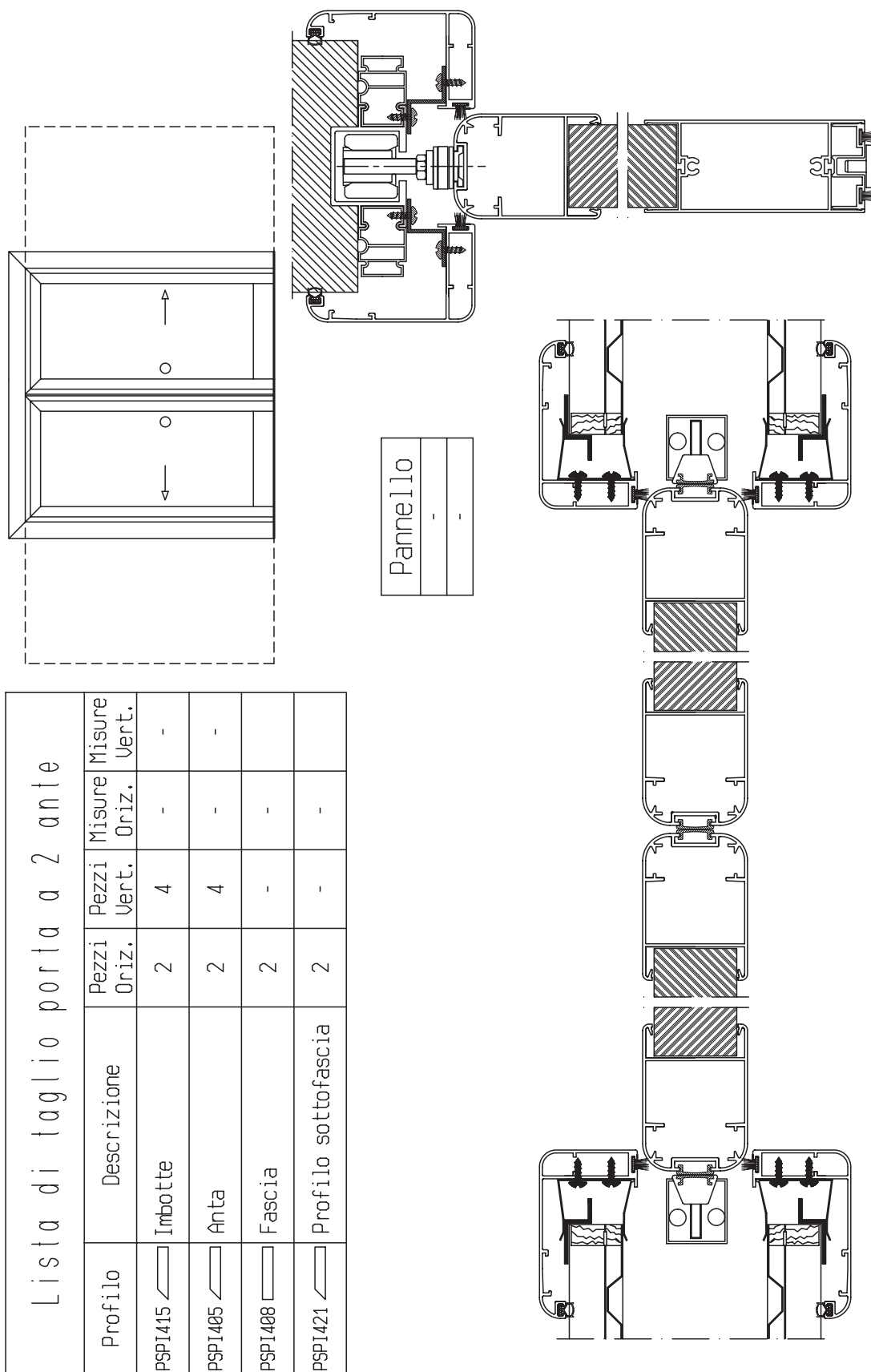

Lista di taglio porta a 2 ante

Profilo	Descrizione	Pezzi Oriz.	Pezzi Vert.	Misure Oriz.	Misure Vert.
PSP1415	Imbotte	2	4	-	-
PSP1405	Anta	2	4	-	-
PSP1408	Fascia	2	-	-	-
PSP1421	Profilo sottofascia	2	-	-	-



PERSEA[®]
SISTEMI PORTE INTERNE



www.persea.eu