Produzione pannelli bugnati

CATALOGO 2016





Art. 61 - GUINEA



Art. 1 - ALGERIA



Art. 93 - TAIWAN



Art. 14 - SIRIA



Art. 118 - ALABAMA



Art. 86 - DANIMARCA



Art. 57 - GIAMAICA



Art. 35 - URUGUAY



ART. 104 - COLOMBIA



ART. 69 - LETTONIA



ART. 109 - COREA



ART. 26 - SUD AFRICA



ART. 79/B - COSTA RICA



ART. 33 - LIBERIA



ART. 62 - GUATEMALA



ART. 49 - MESSICO



ART. 127 - ILLINOIS



ART. 46 - NORVEGIA



ART. 56 - GERMANIA



ART. 82/A - CILE

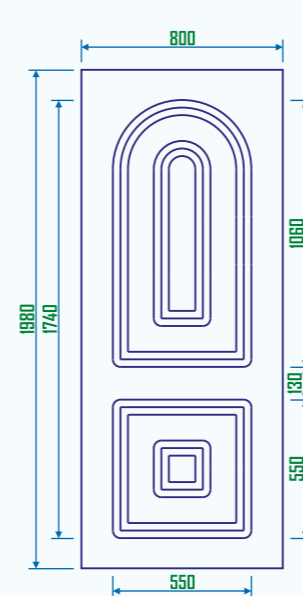

ART. 1 - ALGERIA

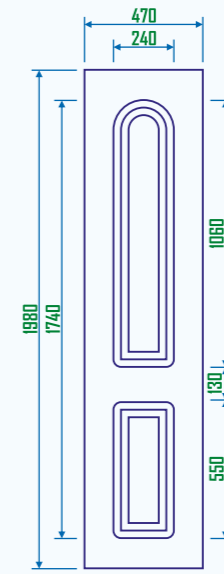

ART. 2 - ARGENTINA

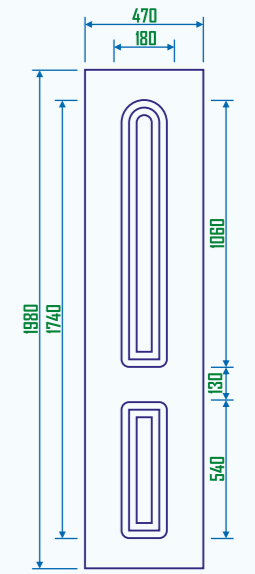

ART. 3 - AUSTRALIA

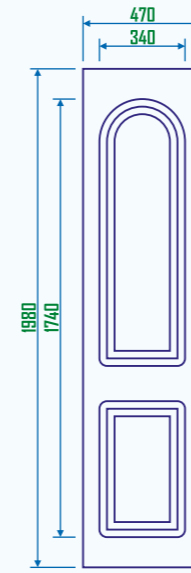

ART. 4 - AUSTRIA

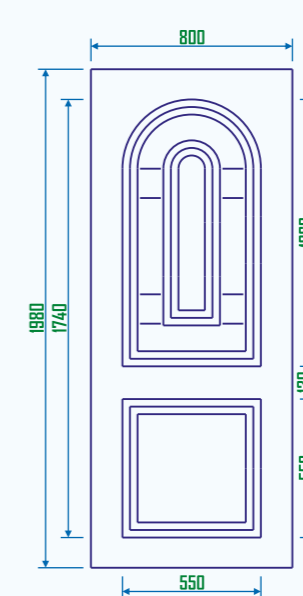

ART. 5 - BOLIVIA

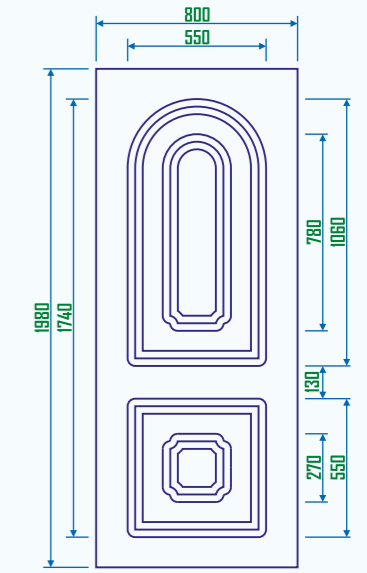

ART. 6 - UGANDA

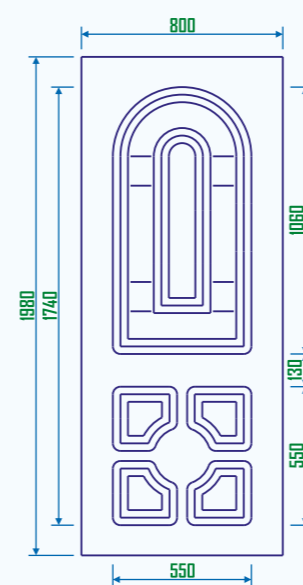

ART. 7 - UNGHERIA

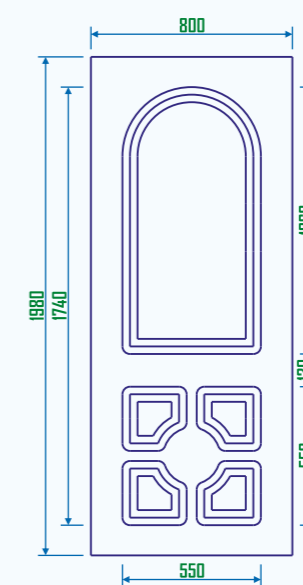

ART. 8 - VENEZUELA

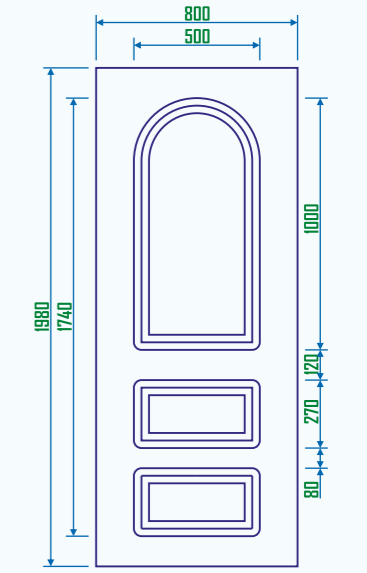

ART. 9 - VIETNAM

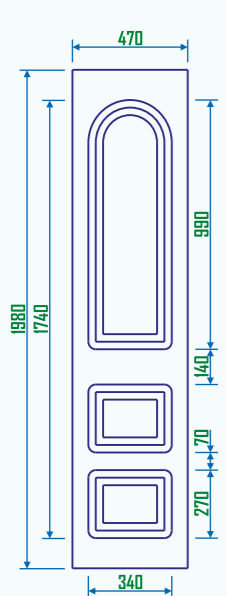

Art. 10 - ROMANIA

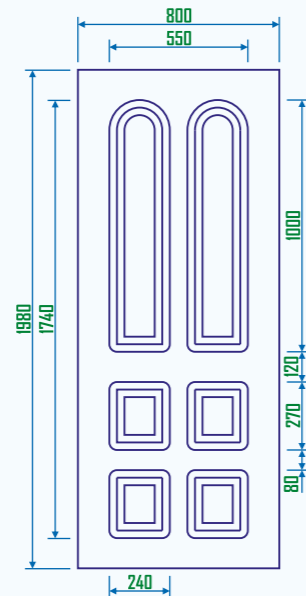

Art. 11 - THAILANDIA

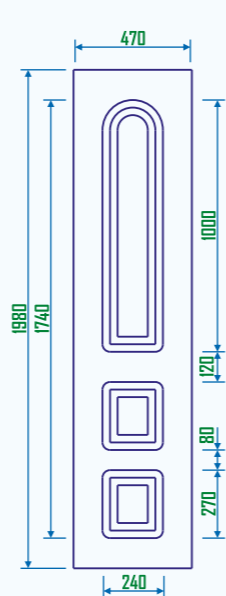

Art. 12 - ALASKA

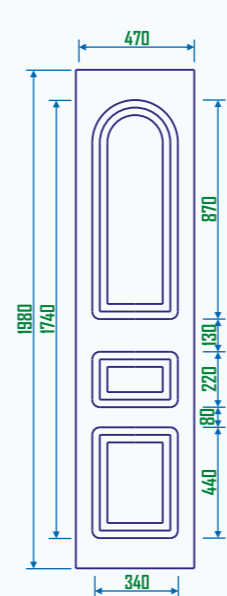

Art. 19 - SENEGAL

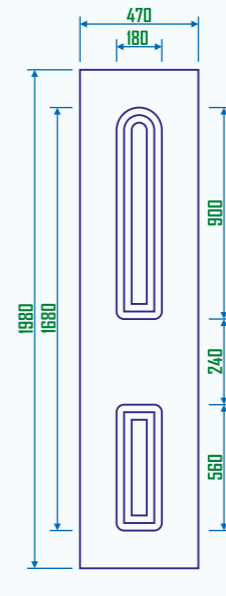

Art. 20 - RUANDA

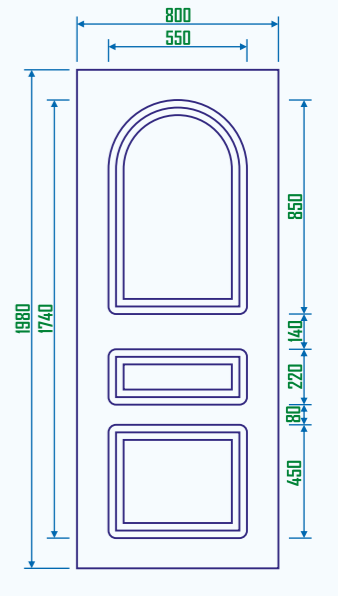

Art. 21 - RUSSIA

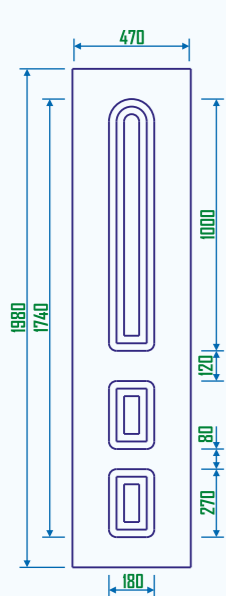

Art. 13 - SUDAN

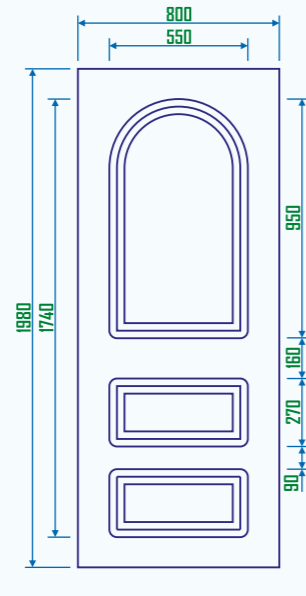

Art. 14 - SIRIA

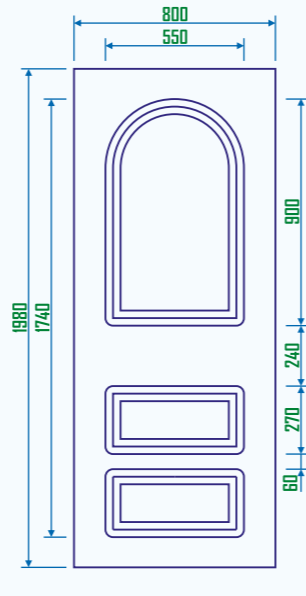

Art. 15 - SINGAPORE

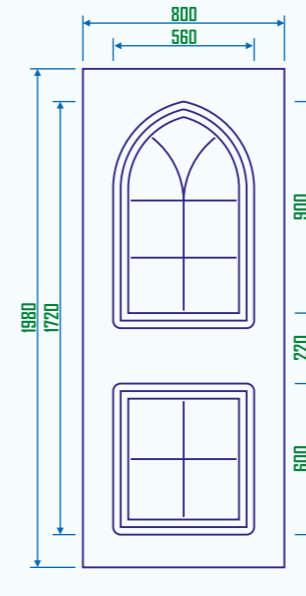

Art. 22 - SLOVACCHIA

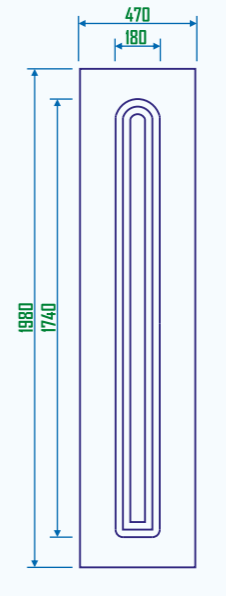

Art. 23 - SLOVENIA

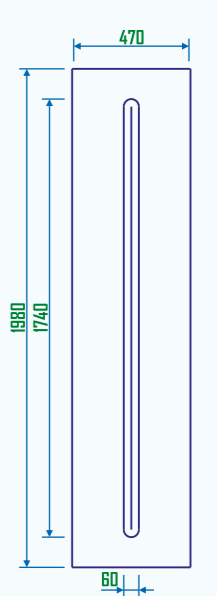

Art. 24 - SPAGNA

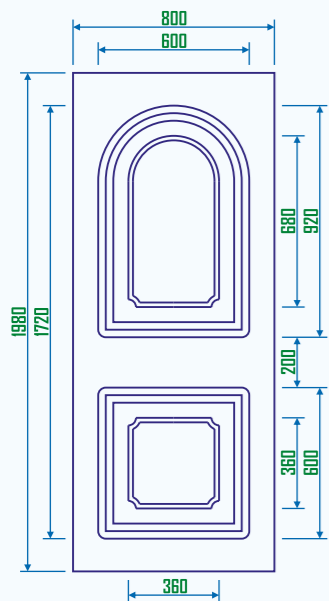

Art. 16 - TANZANIA

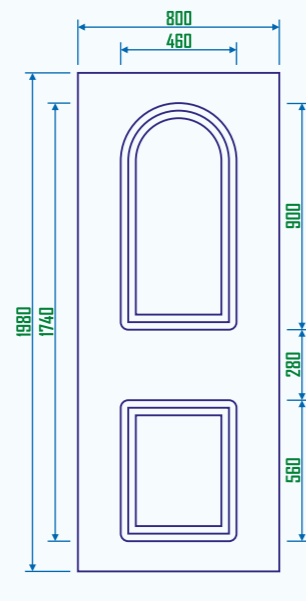

Art. 17 - SAN MARINO

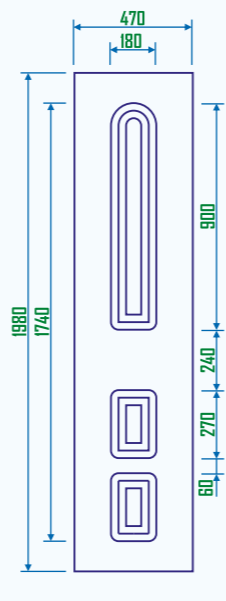

Art. 9 - OKLAOMA

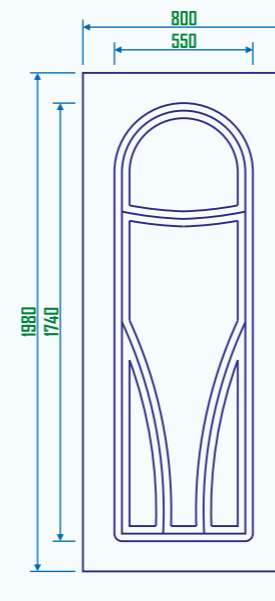

Art. 25 - SOMALIA

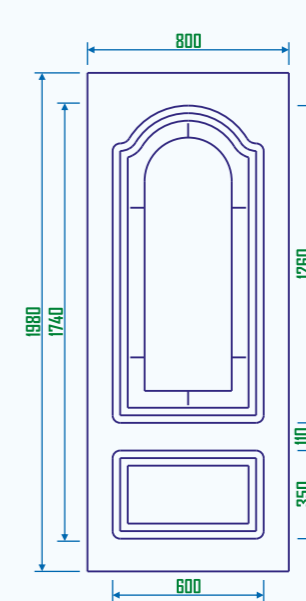

Art. 26 - SUD AFRICA

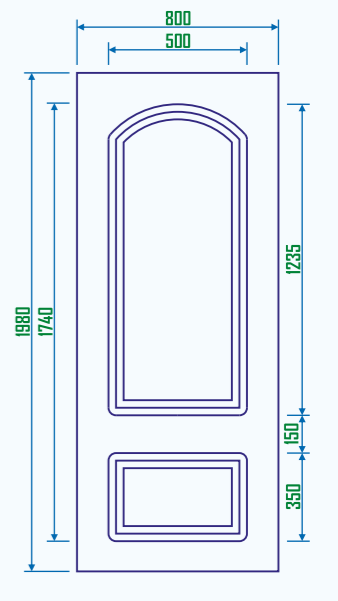

Art. 27 - STATI UNITI

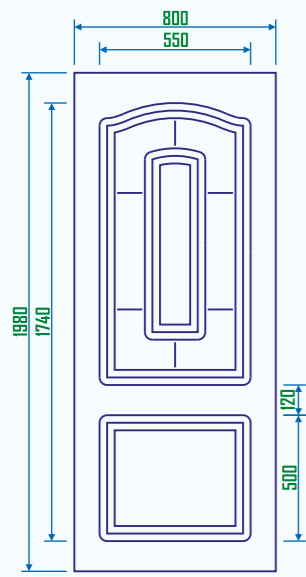

ART. 28 - FRANCIA

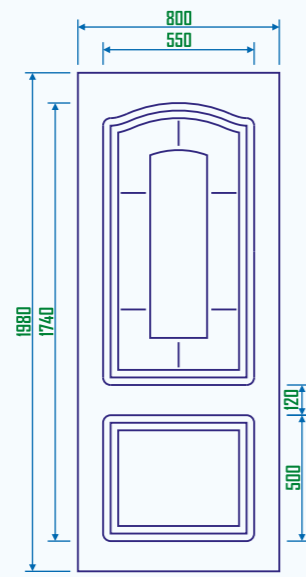

ART. 29 - SVEZIA

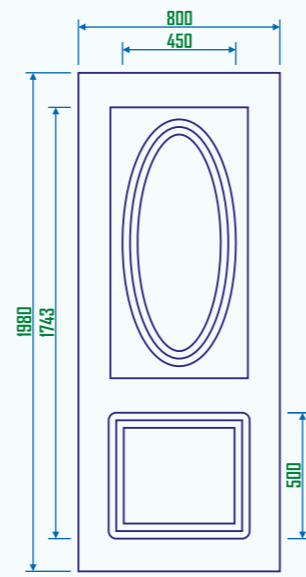

ART. 30 - SVIZZERA

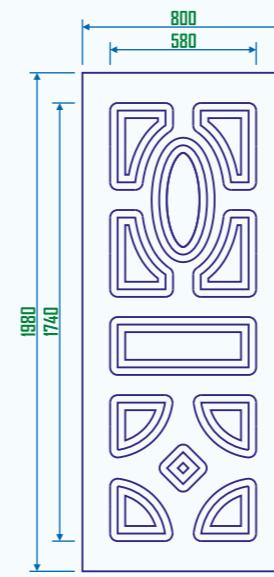

ART. 37 - LITUANIA

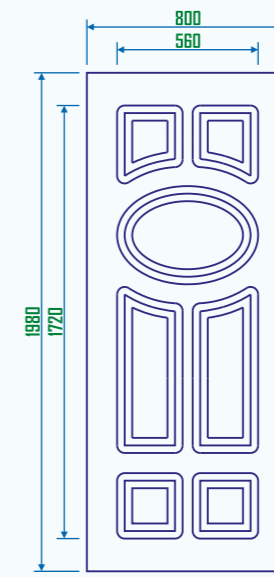

ART. 38 - MALDIVE

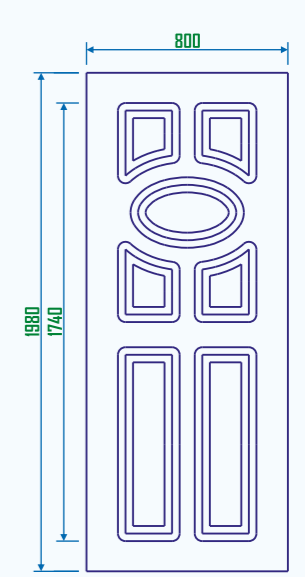

ART. 39 - MAROCCO

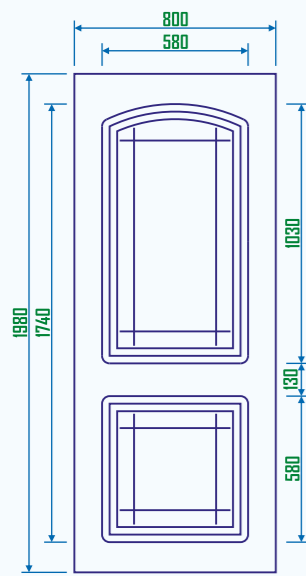

ART. 31 - TUNISIA

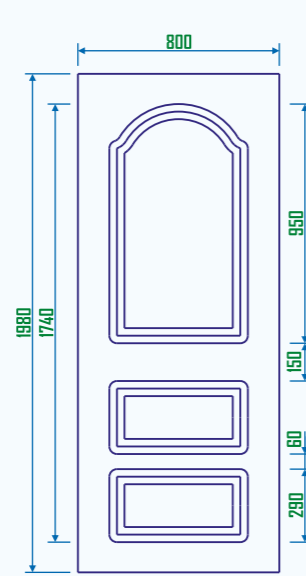

ART. 32 - TURCHIA

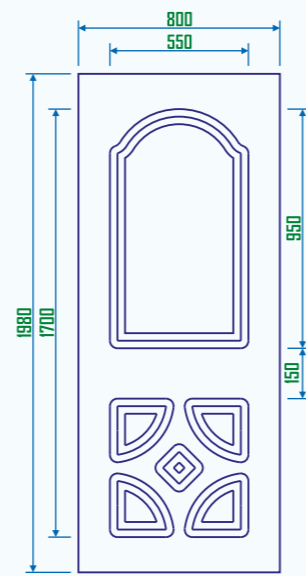

ART. 33 - LIBERIA

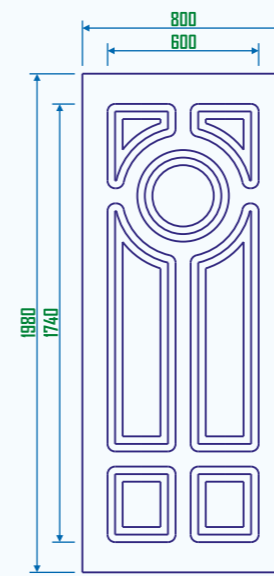

ART. 40 - NEPAL

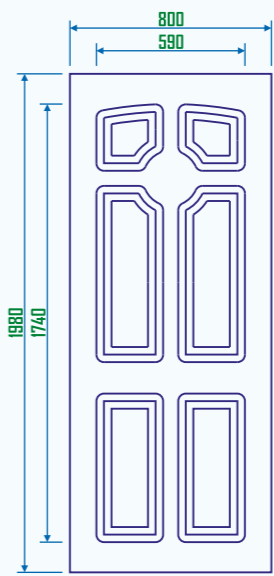

ART. 41 - MONACO

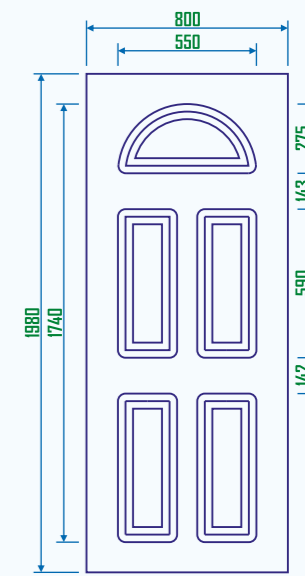

ART. 42 - MOLDAVIA

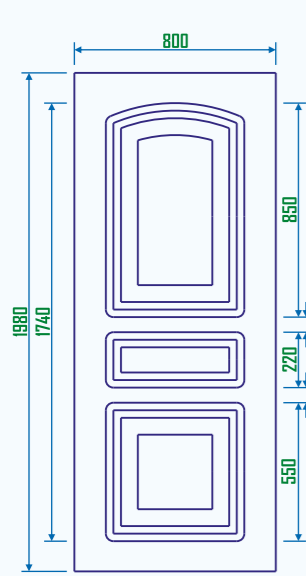

ART. 34 - LIBANO

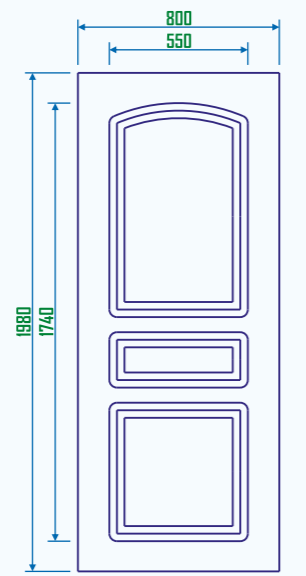

ART. 35 - URUGUAY

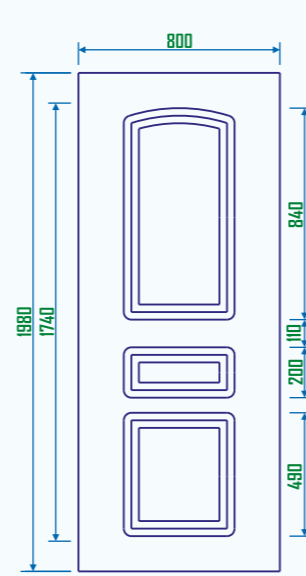

ART. 36 - UCRAINA

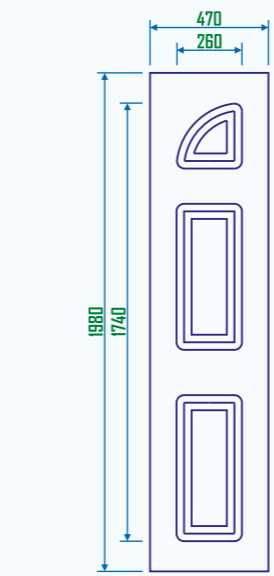

ART. 43/A - MONGOLIA

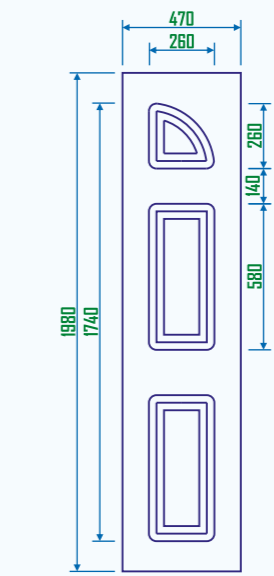

ART. 43/B - MONGOLIA

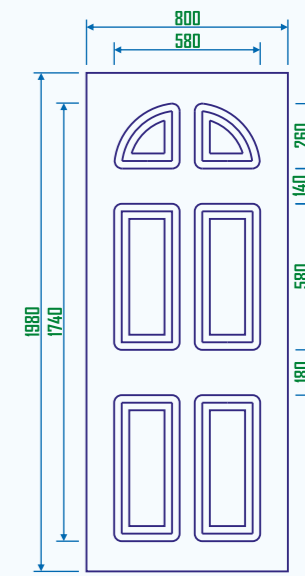

ART. 44 - NICARAGUA

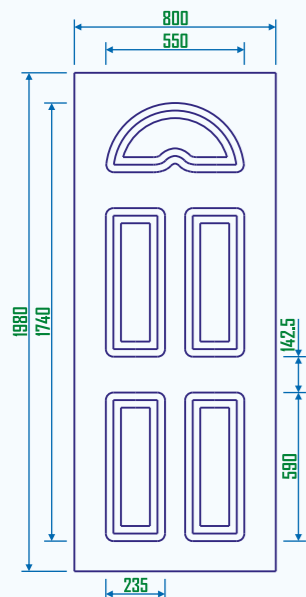

ART. 45 - NIGERIA

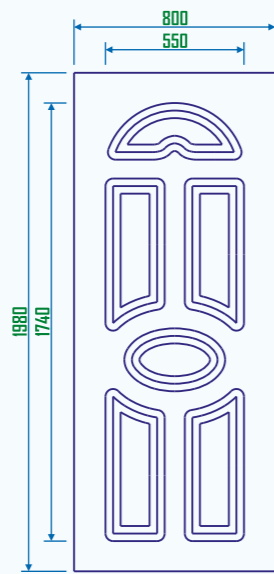

ART. 46 - NORVEGIA

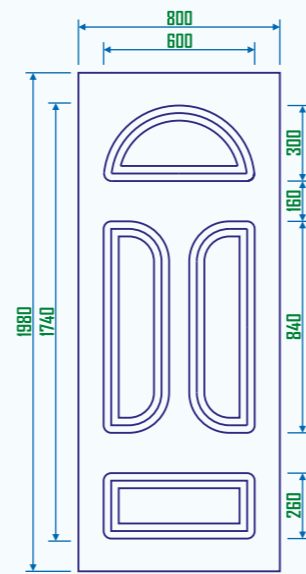

ART. 47 - PAKISTAN

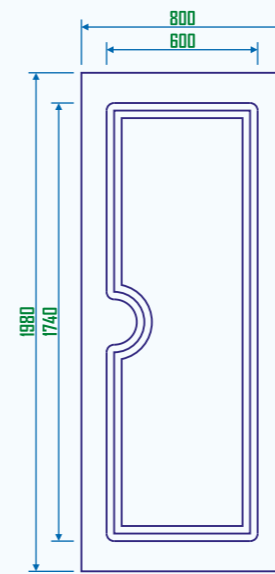

ART. 54 - PORTOGALLO

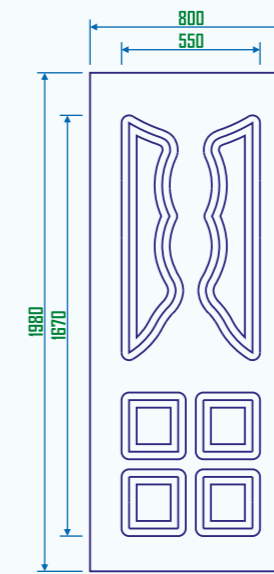

ART. 55 - POLONIA

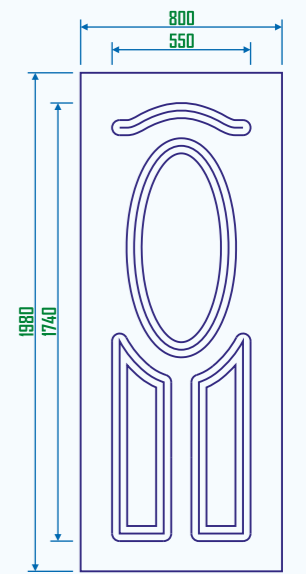

ART. 56 - GERMANIA

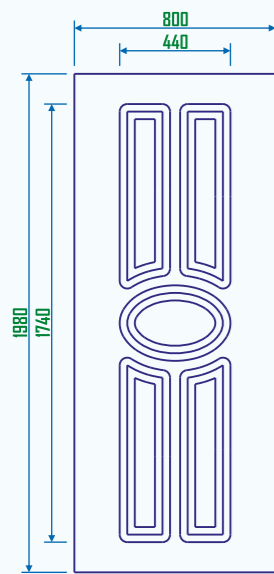

ART. 48 - PANAMA

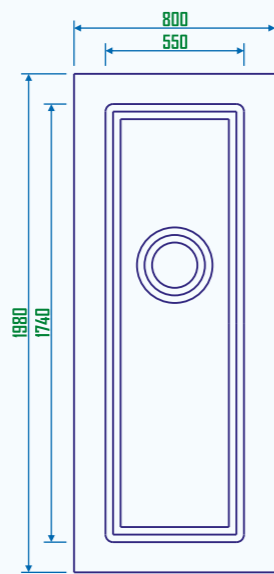

ART. 49 - MESSICO

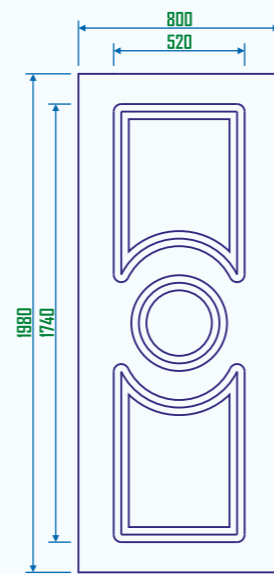

ART. 50 - PARAGUAY

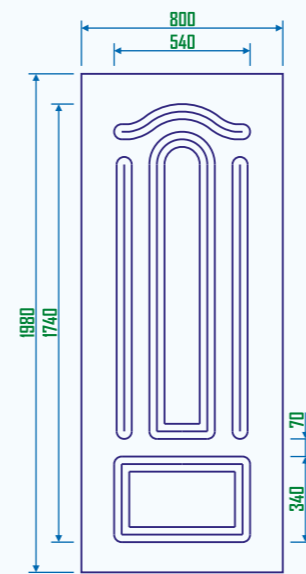

ART. 57 - GIAMAICA

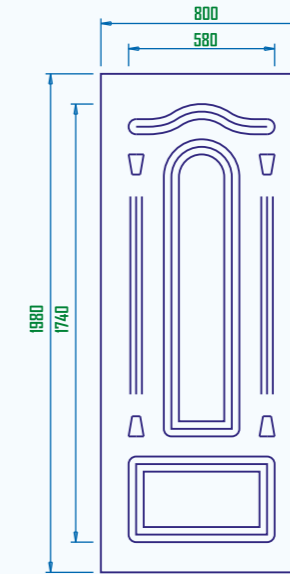

ART. 58 - GIAPPONE

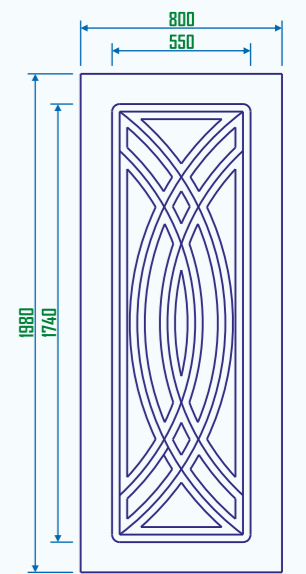

ART. 59 - GIORDANIA

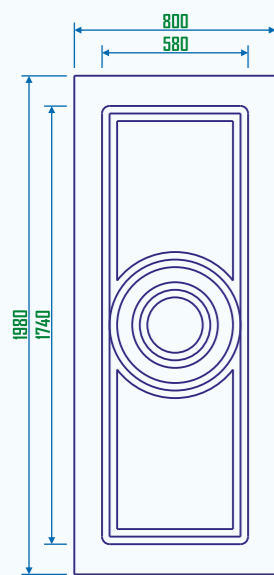

ART. 51 - PERÙ

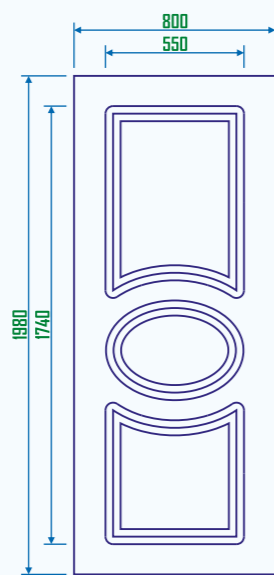

ART. 52 - GEORGIA

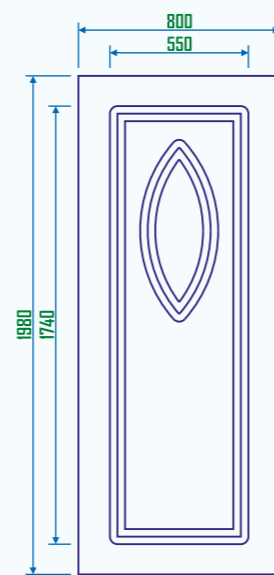

ART. 53 - PORTO RICO

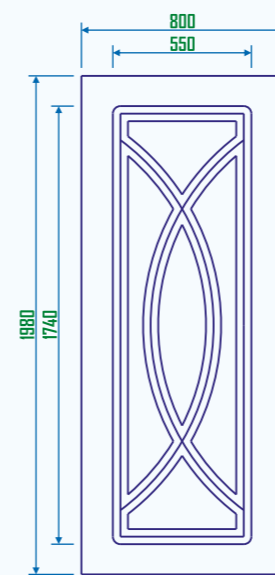

ART. 60 - HAITI

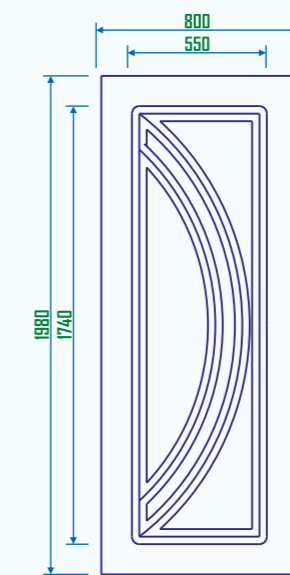

ART. 61 - GUINEA

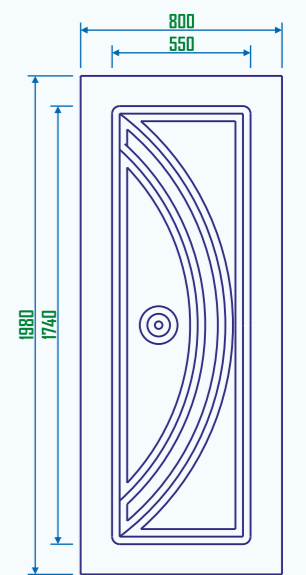

ART. 62 - GUATEMALA

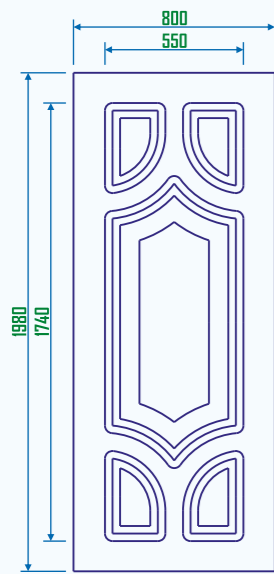

ART. 63 - GRECIA

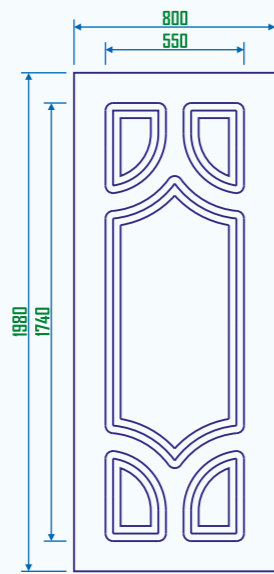

ART. 64 - ISLANDA

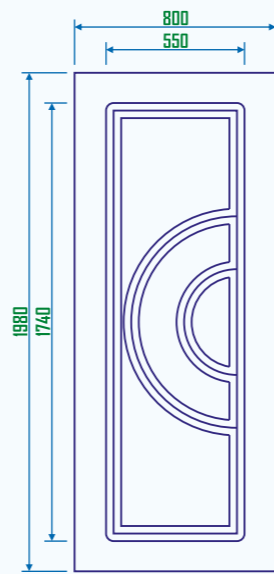

ART. 65 - IRLANDA

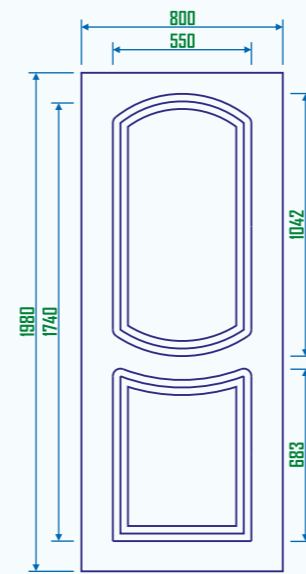

ART. 72 - BAHAMAS

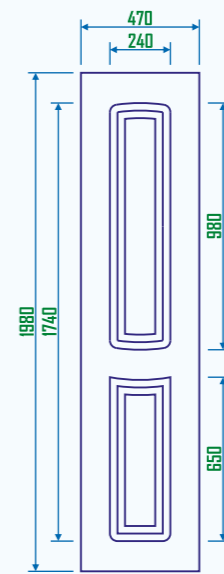

ART. 73 - BARBADOS

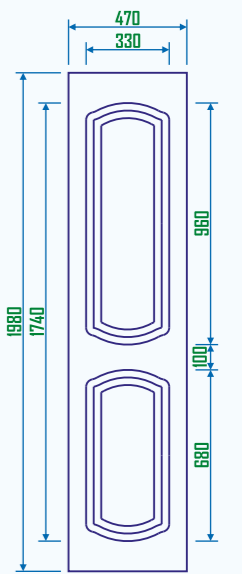

ART. 74 - BELGIO

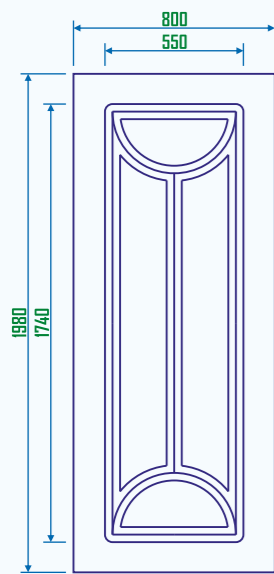

ART. 66 - INDONESIA

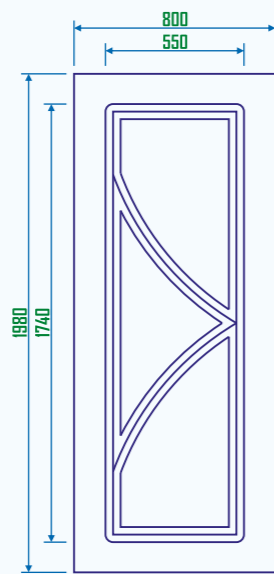

ART. 67 - INDIA

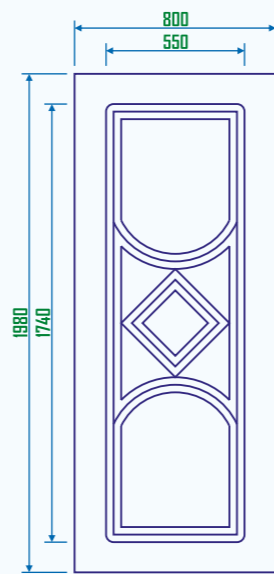

ART. 68 - LIBIA

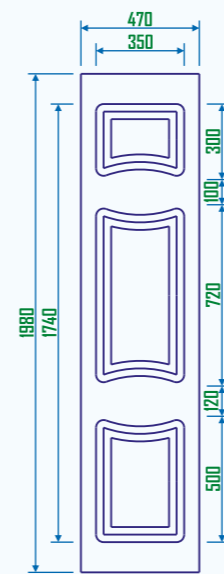

ART. 75 - BIRMANIA

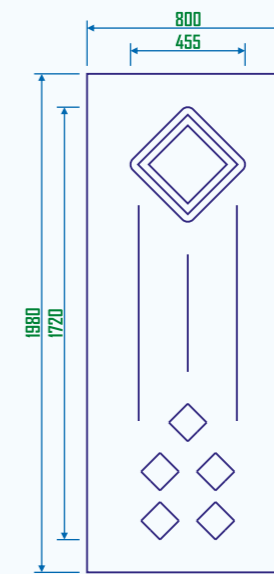

ART. 76 - CAMBOGIA

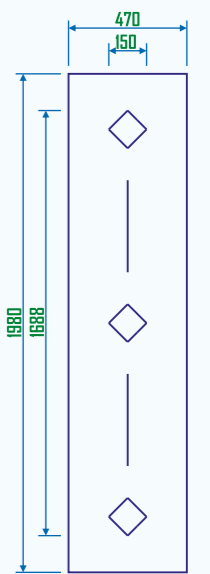

ART. 77 - BULGARIA

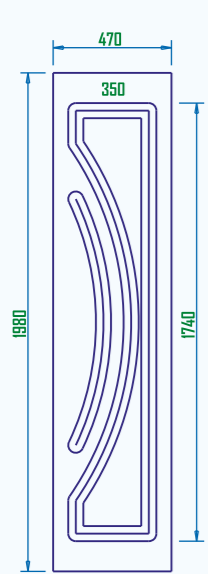

ART. 69 - LETONIA

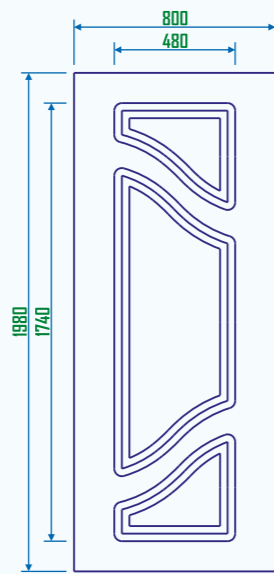

ART. 70 - ITALIA

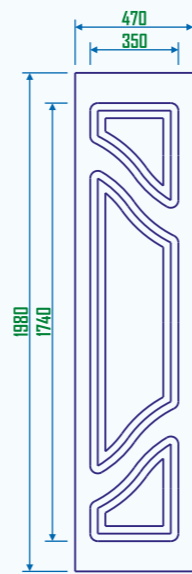

ART. 71 - KENYA

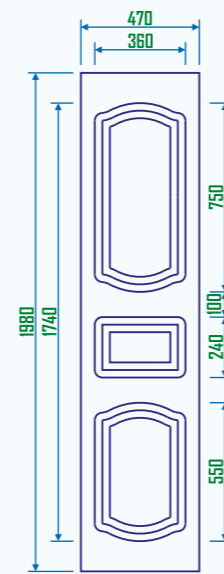

ART. 78 - BRASILE

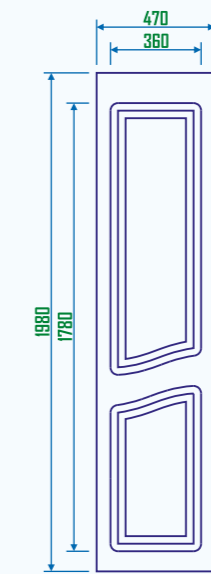

ART. 79/A - COSTA RICA

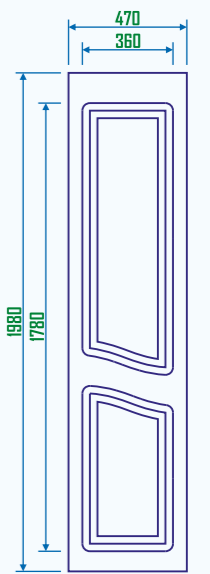

ART. 79/B - COSTA RICA

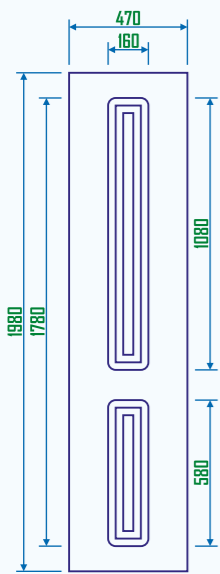

Art. 80 - BOSNIA

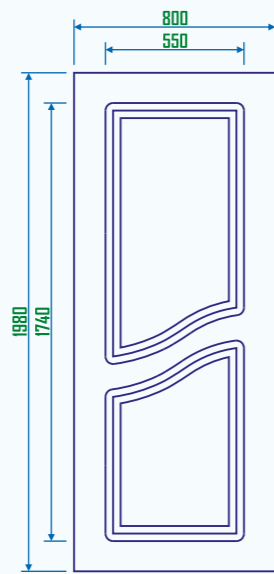

Art. 81/A - CANADA

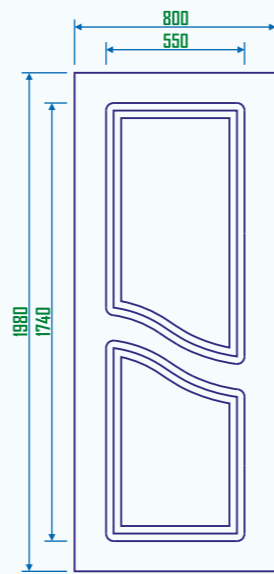

Art. 81/B - CANADA

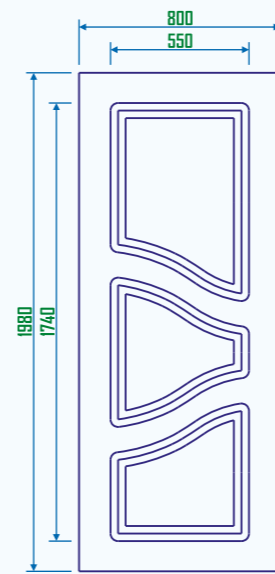

Art. 85/A - CINA

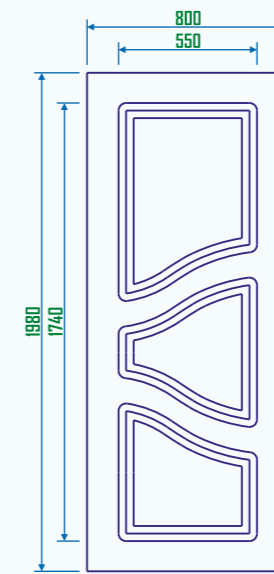

Art. 85/B - CINA

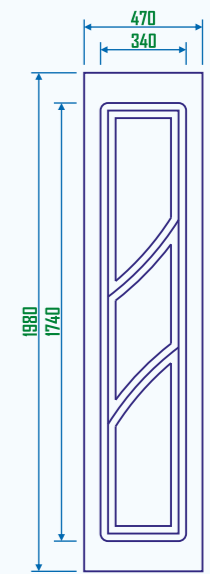

Art. 86/A - DANIMARCA

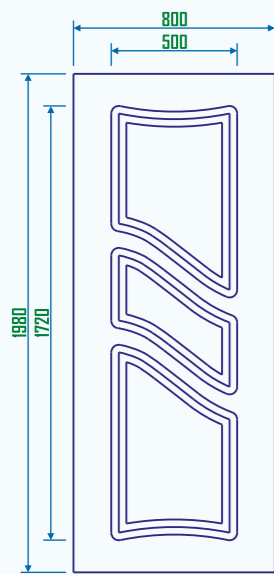

Art. 82/A - CILE

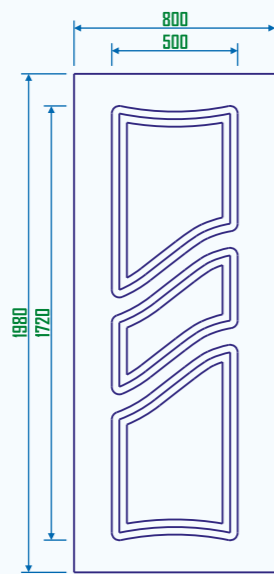

Art. 82/B - CILE

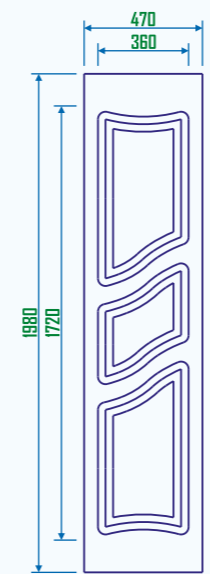

Art. 83/A - CIPRO

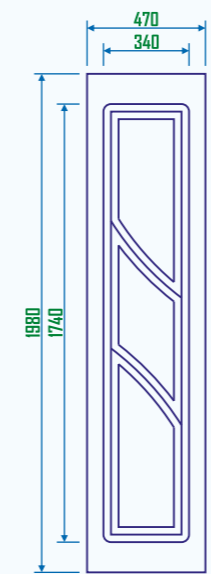

Art. 86/B - DANIMARCA

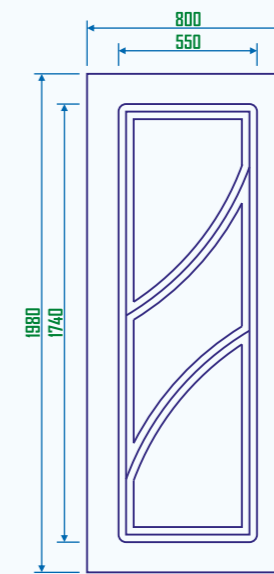

Art. 87/A - ECUADOR

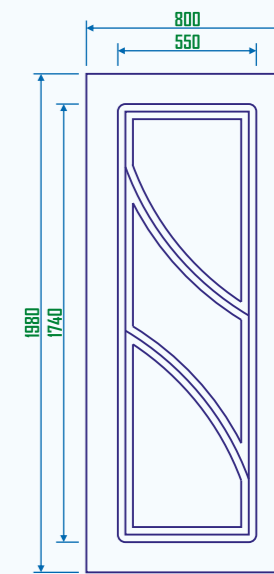

Art. 87/B - ECUADOR

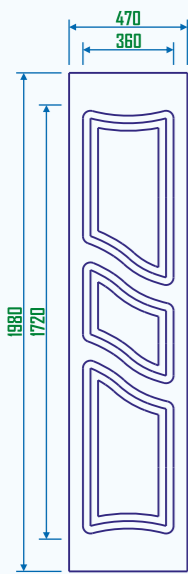

Art. 83/B - CIPRO

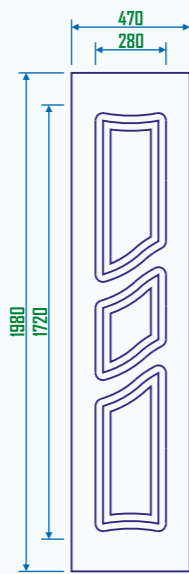

Art. 84/A - CUBA

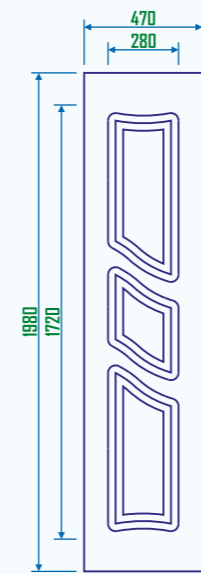

Art. 84/B - CUBA

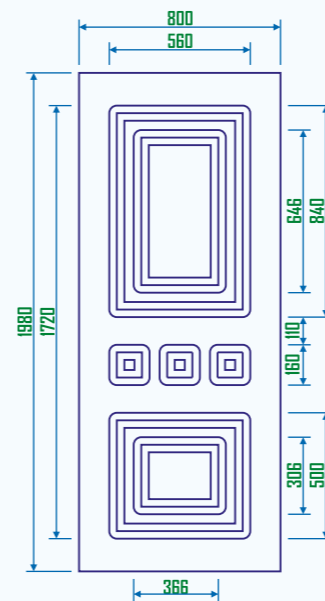

Art. 88 - EGITTO

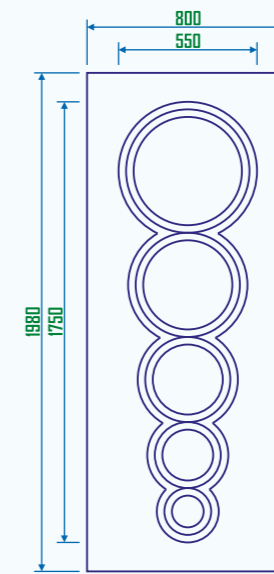

Art. 89 - ERITREA

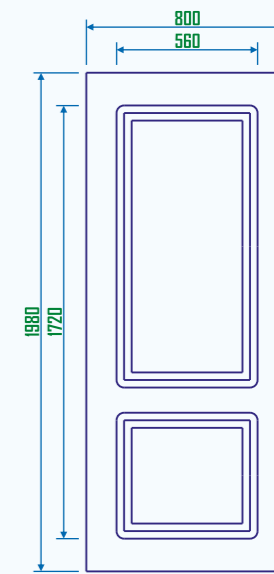

Art. 90 - ESTONIA

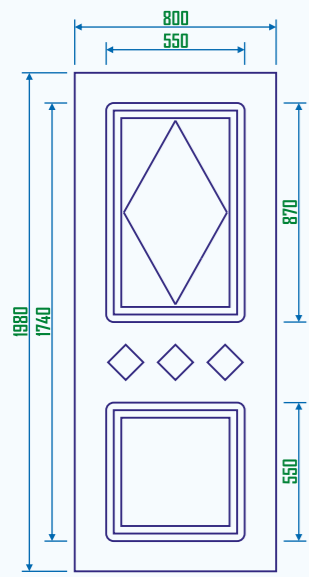

Art. 91 - ETIOPIA

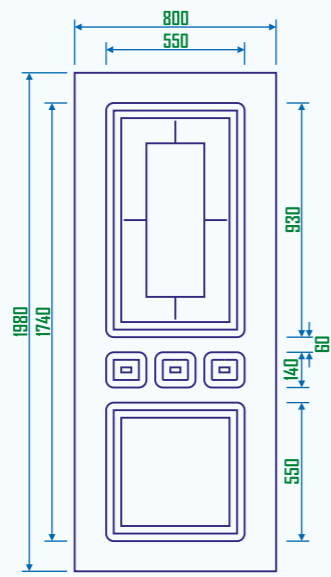

Art. 92 - ZAMBIA

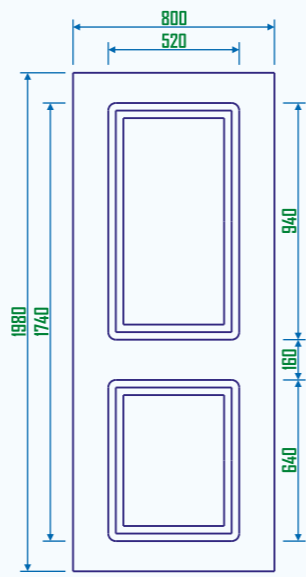

Art. 93 - TAIWAN

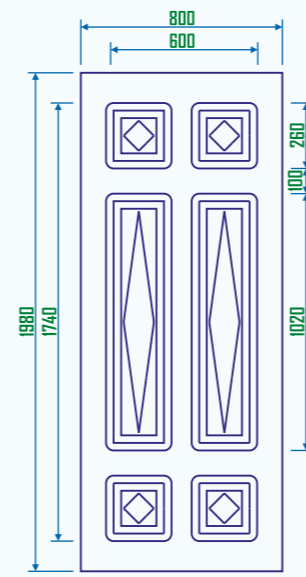

Art. 100 - MALESIA

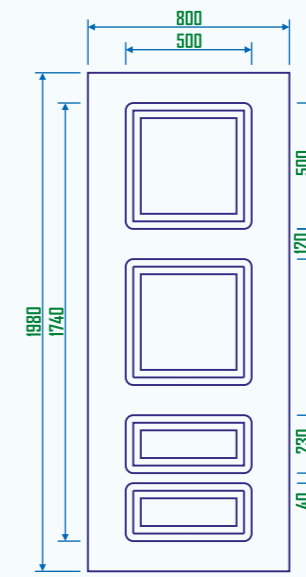

Art. 101 - NUOVA ZELANDA

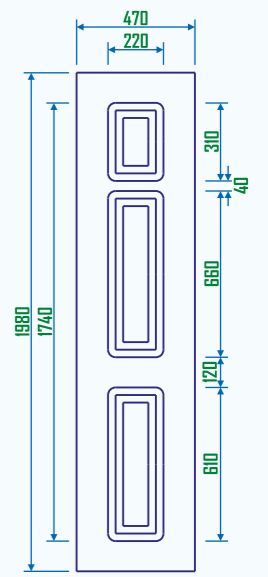

Art. 102 - MONTENEGRO

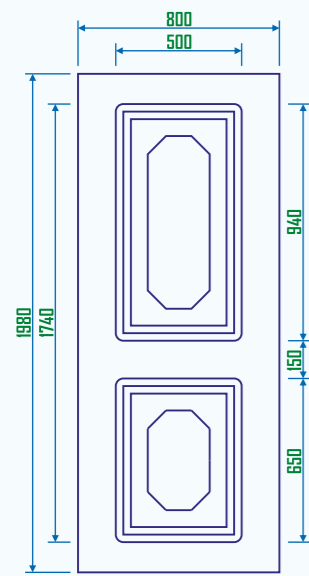

Art. 94 - FINLANDIA

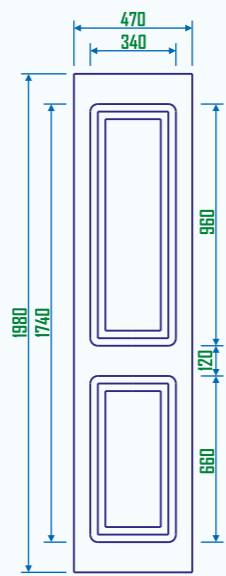

Art. 95 - FILIPPINE

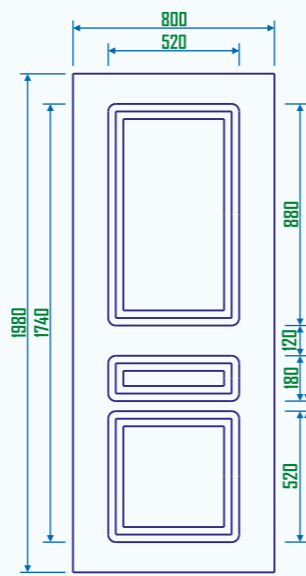

Art. 96 - MADAGASCAR

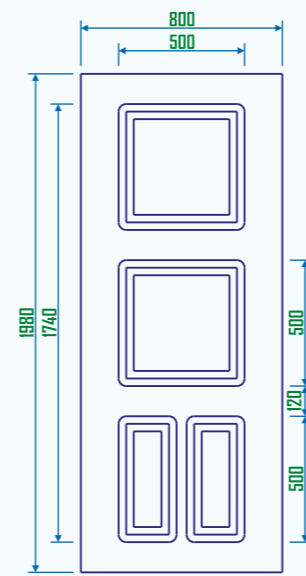

Art. 103 - GHANA

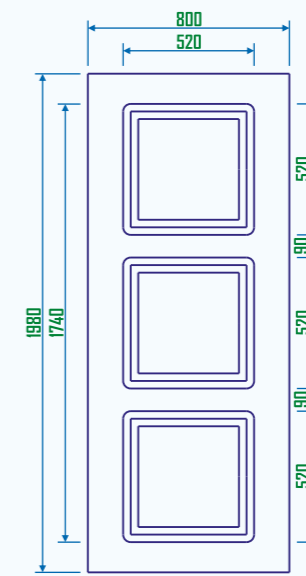

Art. 104 - COLOMBIA

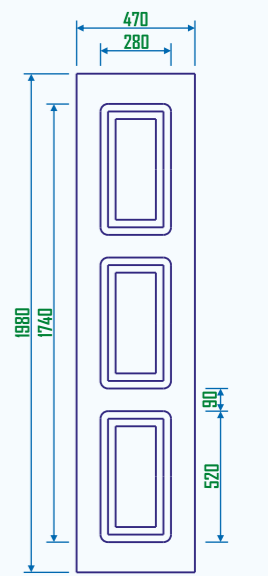

Art. 105 - CAPO VERDE

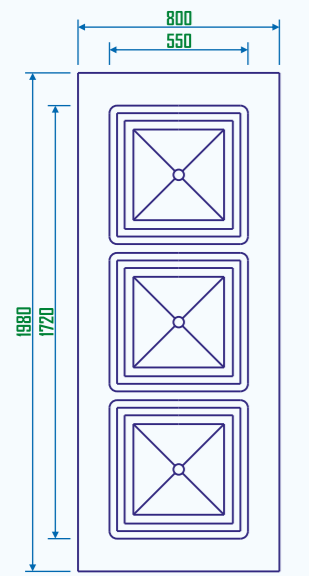

Art. 97 - MALTA

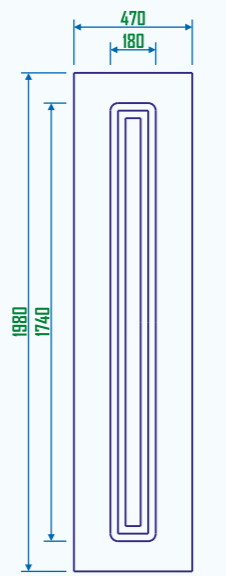

Art. 98 - LUSSEMBURGO

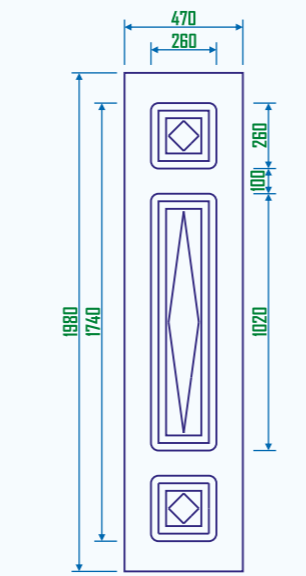

Art. 99 - PAESI BASSI

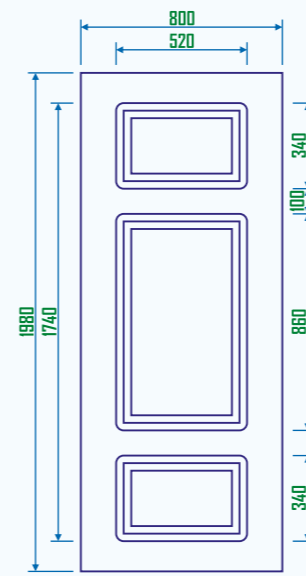

Art. 106 - BHUTAN

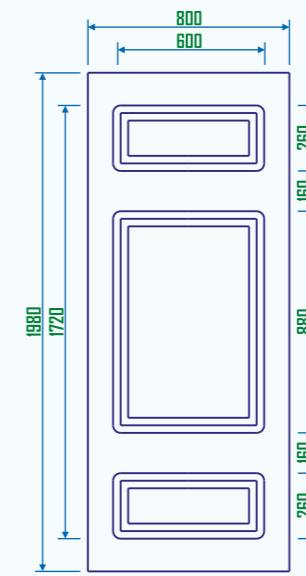

Art. 107 - DOMINICA

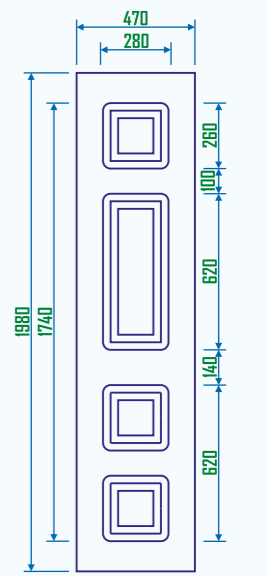

Art. 108 - BURUNDI

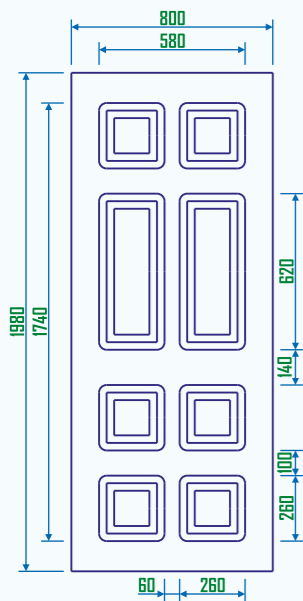

Art. 109 - COREA

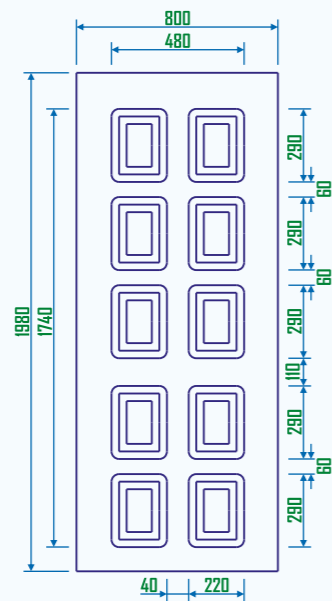

Art. 110 - COMORE

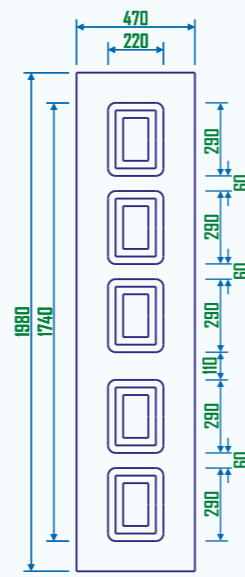

Art. 111 - NEW YORK

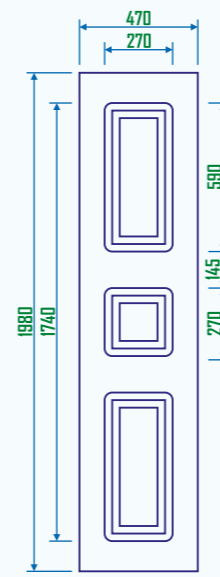

Art. 118 - ALABAMA

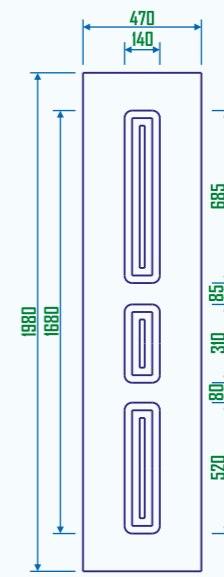

Art. 119 - TEXAS

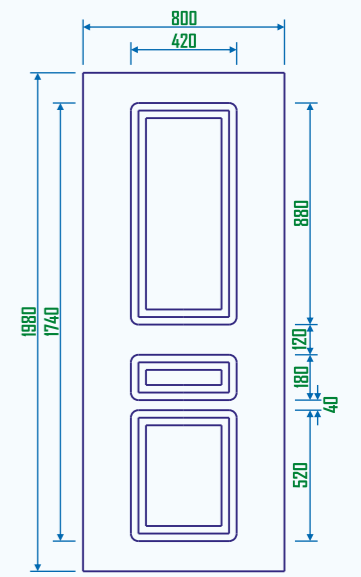

Art. 120 - OREGON

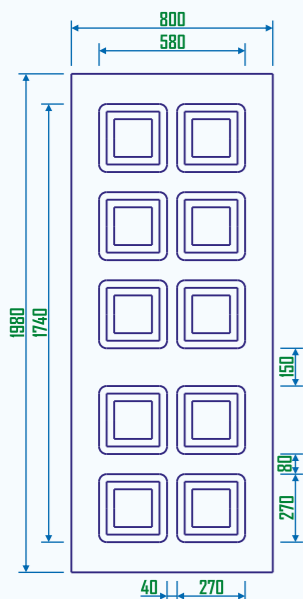

Art. 112 - ARMENIA

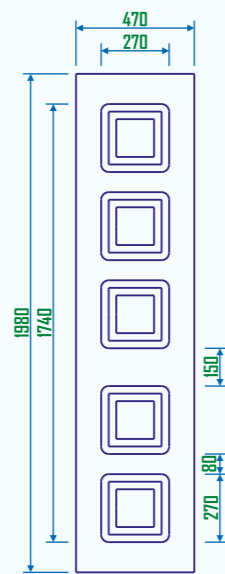

Art. 113 - MARYLAND

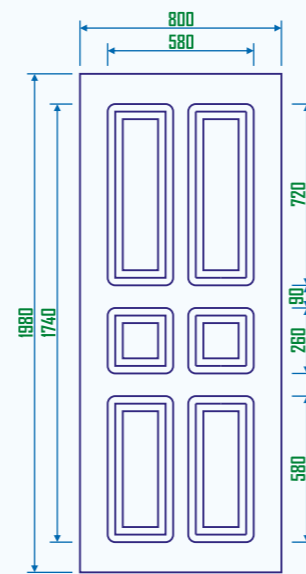

Art. 114 - FLORIDA

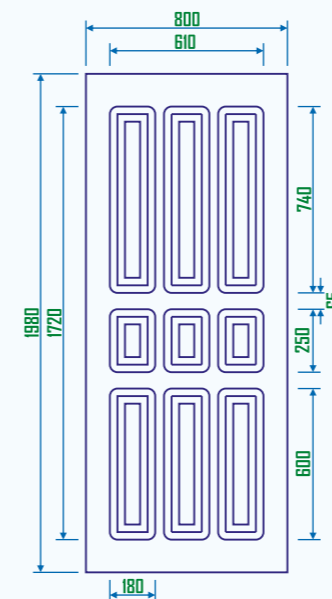

Art. 121 - CALIFORNIA

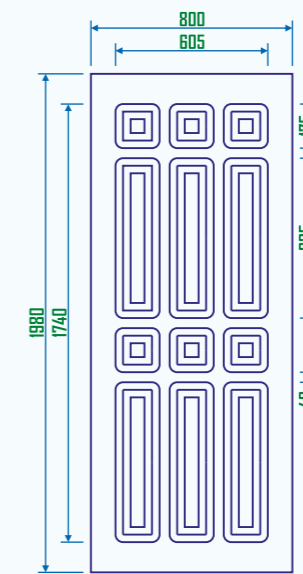

Art. 122 - MONTANA

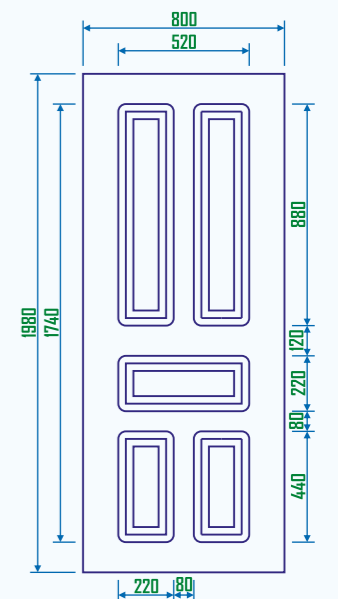

Art. 123 - NEVADA

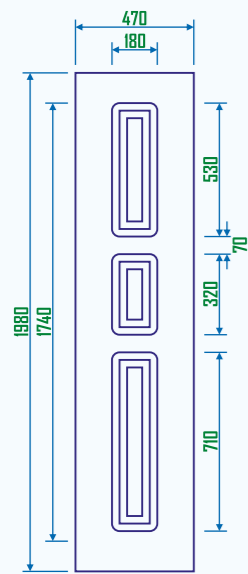

Art. 115 - VERMONT

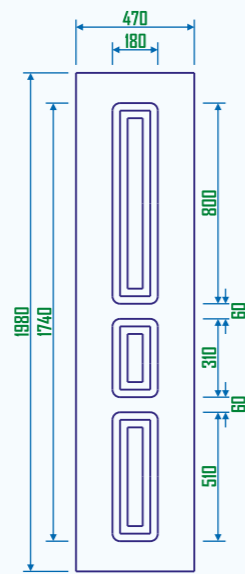

Art. 116 - ARIZONA

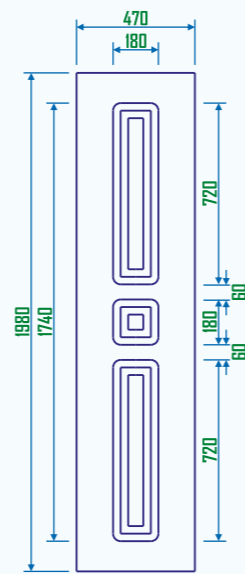

Art. 117 - COLORADO

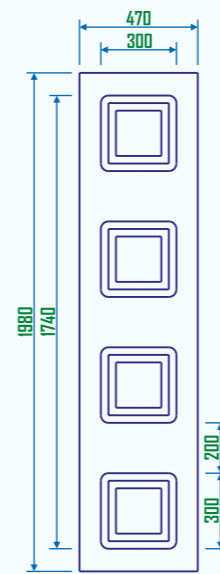

Art. 124 - OHIO

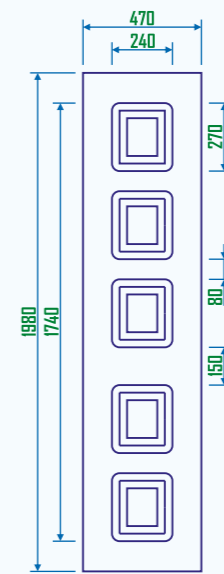

Art. 125 - MISSOURI

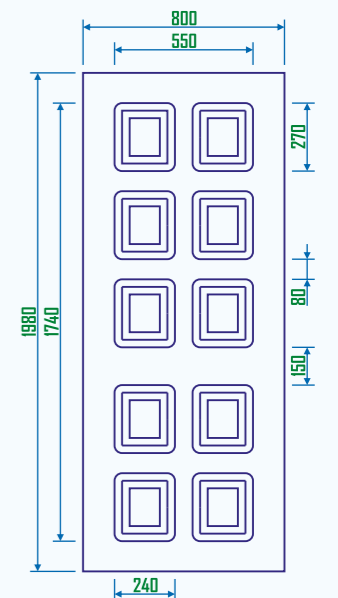

Art. 126 - MINNESOTA

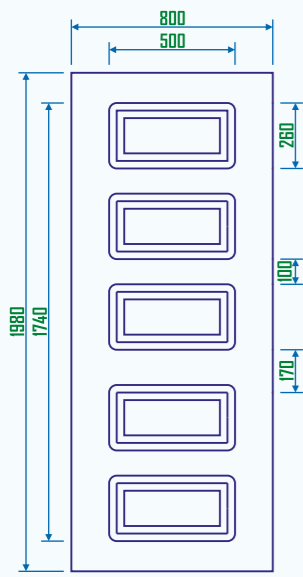

Art. 127 - ILLINOIS

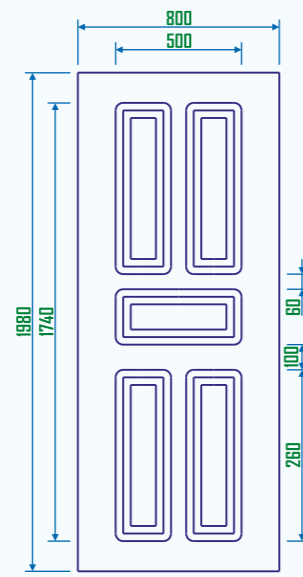

Art. 128 - AZZORRE

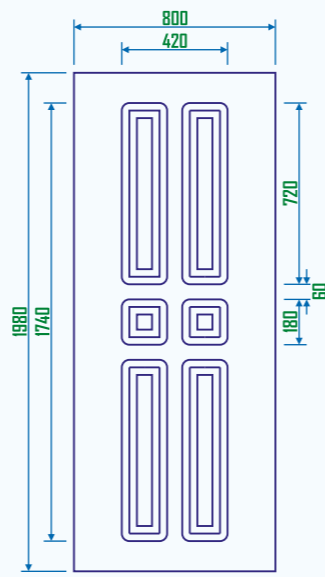

Art. 129 - LOUISIANA

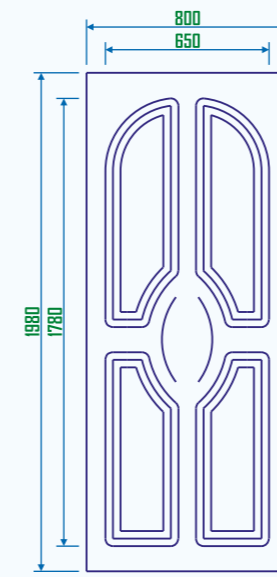

Art. 135 - PARIGI DOPPIO

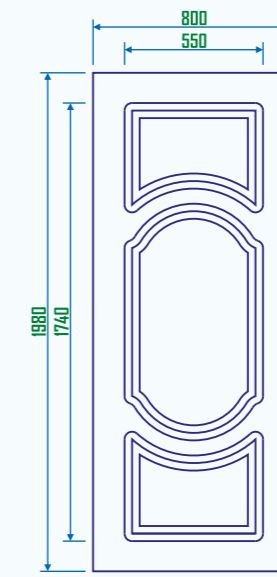

Art. 136 - MADRID

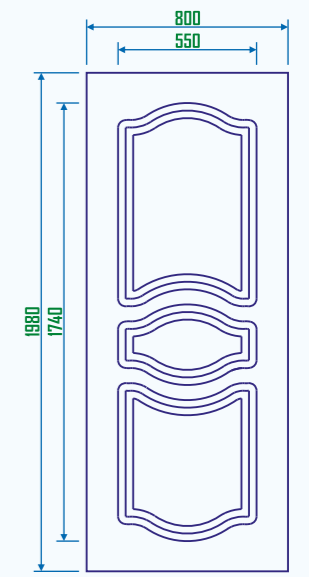

Art. 137 - LISBONA

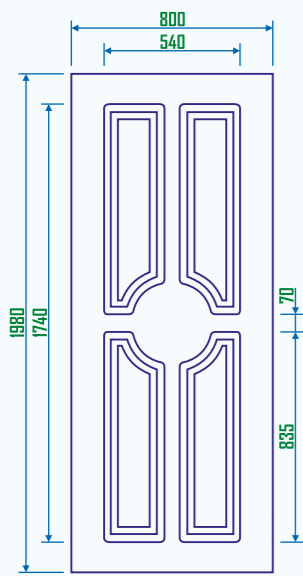

Art. 130 - PRINCIPATO di MONACO

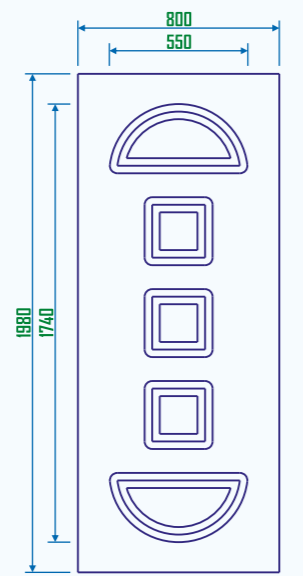

Art. 131 - ANDORRA

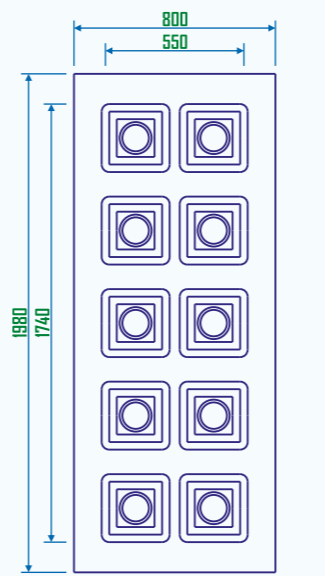

Art. 132 - OLANDA

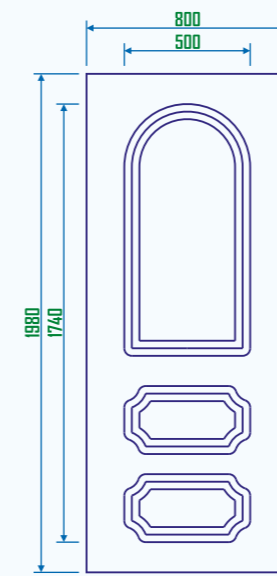

Art. 138 - POTENZA

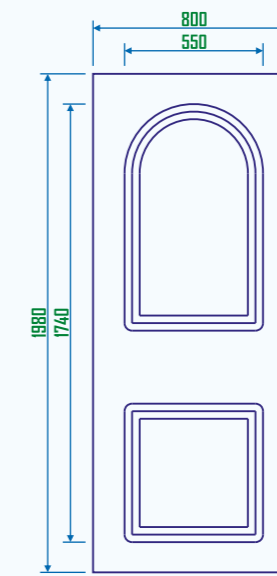

Art. 139 - VARSAVIA

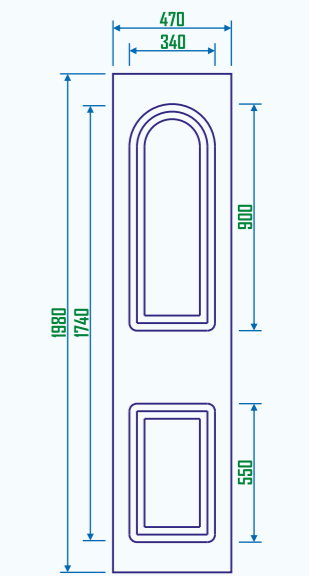

Art. 140 - SALONICCO

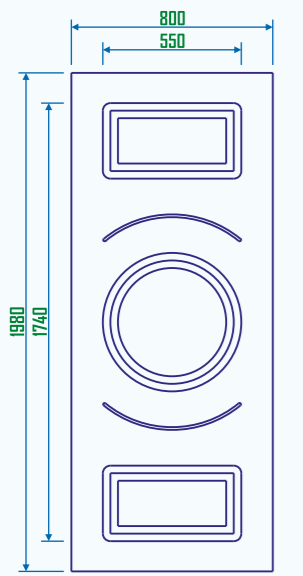

Art. 133 - TRINIDAD

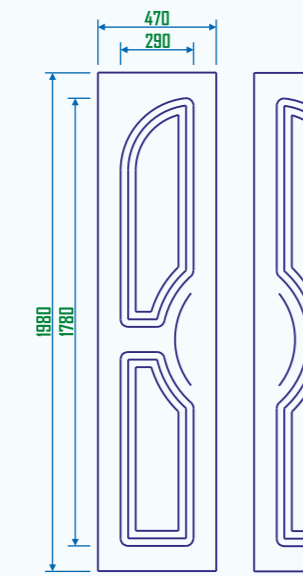

Art. 134 - PARIGI

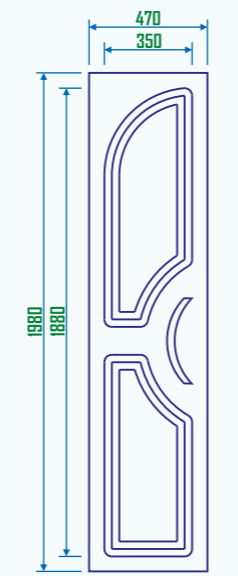
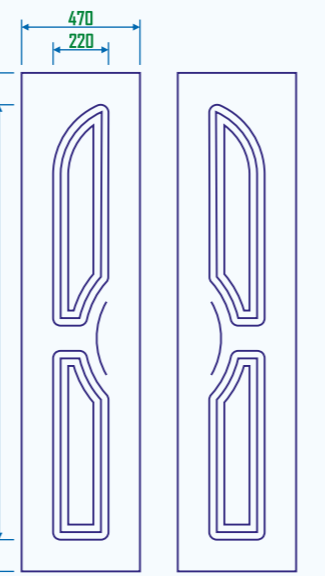

Art. 141/A - ATENE

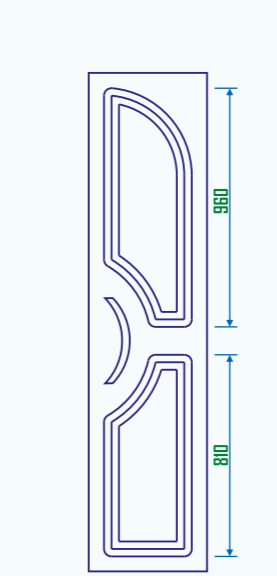

Art. 141/B - ATENE

PERSEA[®] s.r.l

CATALOGO 2016
RIVENDITORE AUTORIZZATO