

www.ponzio.com

www.ponzio.com

Ponzio
van
nel
i

È una sensazione
che fa sentire vivi,
veri, unici.

Avvicinarsi a lui
è come percepire
che tutto è possibile.

Ti guarda, lo sfiori,
si muove, poi fermo
... sussurra:

“Bentornati a casa”.





INDICE | INDEX

La storia del brand Brand history	pag. 8
Made in Ponzio Made in Ponzio	pag. 10
Il portoncino autentico The original aluminium door	pag. 12
L'attenzione all'ambiente Attention to the environment	pag. 13
Le prestazioni Performances	pag. 14
La stratificazione dei pannelli Panels stratification	pag. 16
La gamma dei vetri Glasses range	pag. 18
La nuova cornice fermavetro The new glass stop	pag. 20
I nuovi modelli New models	pag. 22
I portoncini Aluminium doors	pag. 32
Riepilogo modelli Models summary	pag. 92
Listino pannelli Panels price list	pag. 99
Listino vetri Glasses price list	pag. 111
Listino accessori Accessories price list	pag. 125



Ponzio
panel
ii



SCOPRI LE NOVITÀ

L'arma vincente per ottenere grandi risultati è essere precursori dei tempi: i portoncini Bugnall ne sono la prova. Precursore ed innovatore da sempre del mercato dei pannelli in alluminio, il marchio Bugnall apre le porte alla nuova stagione con le esclusive novità dei portoncini che rendono il brand importante riferimento di stile e tendenze.

DISCOVER THE NEWS

The winning weapon to get great results is to be precursors of the times: Bugnall doors are the proof. Always precursor and innovator of aluminum panels market, the brand Bugnall opens the doors to the new season with unique innovations of the doors that make the brand more and more a reference of style and trends.

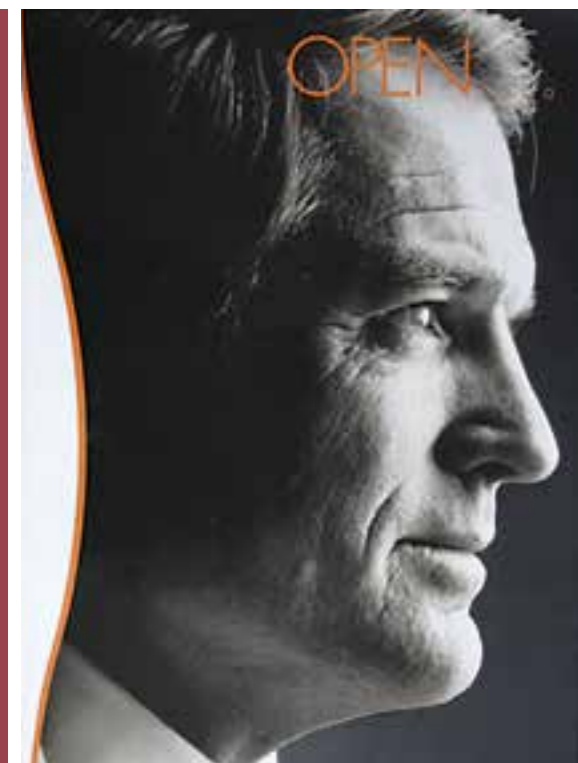
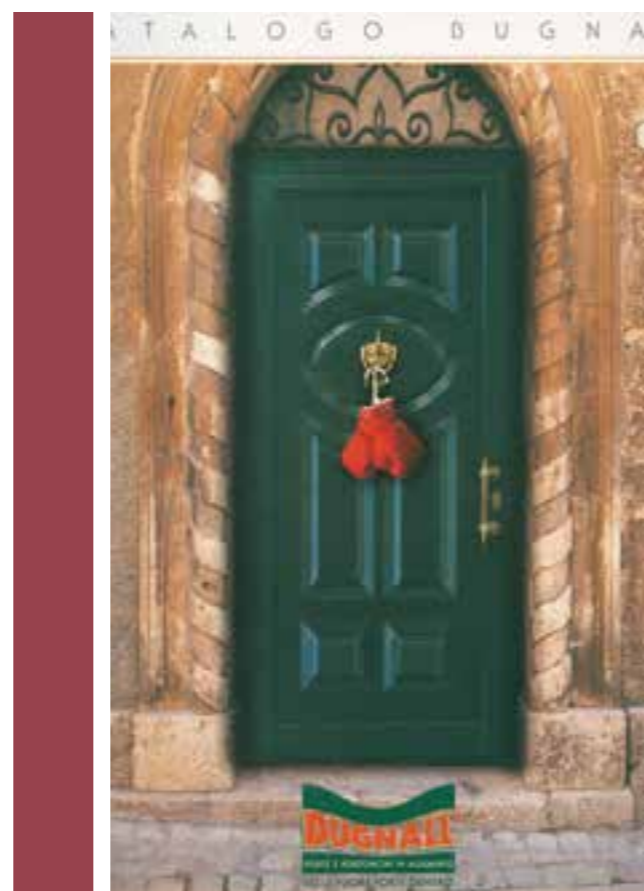
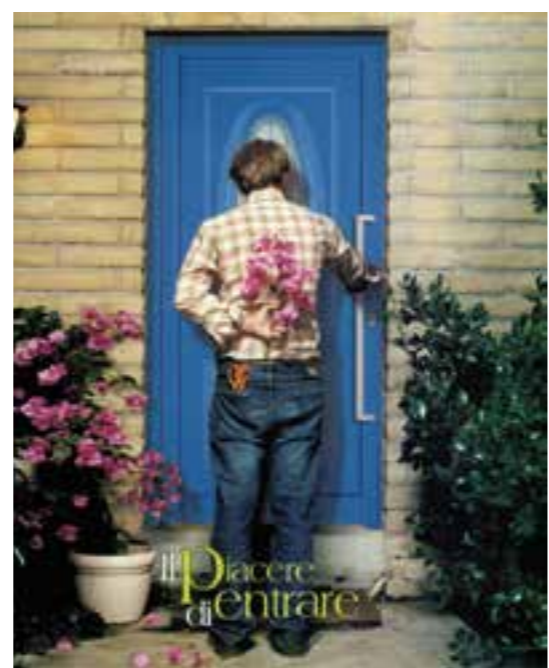
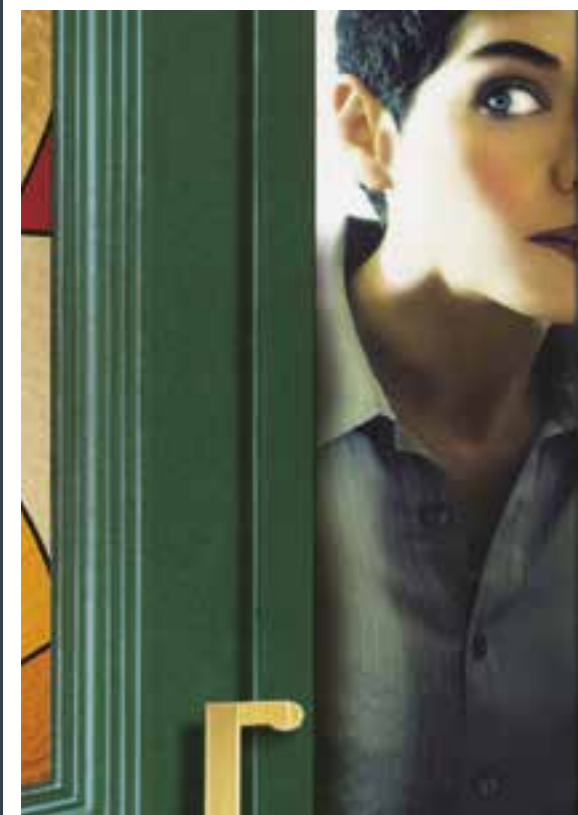

IL NOSTRO PASSATO È LA VERA GARANZIA DEL VOSTRO PRESENTE

“Nomina sunt consequentia rerum” - dicevano i latini. E Bugnall conferma la regola. Bugnall è infatti “Il nome” dei portoncini che da oltre 20 anni continuano a scrivere la storia dei pannelli in alluminio bugnati. Una storia di garanzia ed affidabilità che negli anni ‘90 ha definito e connotato il brand come “precursore” di un nuovo concetto di “apertura”. I portoncini d’ingresso Bugnall, infatti, sono frutto della ricerca continua nell’innovazione che migliora la vita. Uno stile di vita “perfettibile” che parte da una filosofia di lavoro “impeccabile”: quella che contraddistingue la Ponzio, l’azienda produttrice leader nella lavorazione dell’alluminio. Passione, esperienza e capacità produttiva sono gli ingredienti della ricetta perfetta della Ponzio che con il marchio Bugnall rinnova lo sguardo verso il futuro, a garanzia di un presente di successi.

OUR PAST IS THE REAL WARRANTY OF YOUR PRESENT

“Nomina sunt consequentia rerum”- said the Latins, indicating that the names reveal the essence of things. And Bugnall proves the rule. Bugnall, in fact, is “name” of the aluminium doors which for over 20 years has been writing the history of the shaped aluminum panels. A history of reliability and trustworthiness in the 90s that has defined and characterized the brand as a “precursor” of a new concept of “openness”. The entry doors Bugnall are the result of continuous research in the name of innovation that improves life. A “perfectible” lifestyle that starts from a “flawless” philosophy of work: the same that distinguishes Ponzio, the leading manufacturer in aluminum processing. Passion, experience and production capacity are the ingredients of the perfect recipe of Ponzio that, under the brand Bugnall, renews the look towards the future, confident of an extraordinary guarantee, an ongoing success.



I PORTONCINI “LAVORATI” IN CASA: DALLA PROGETTAZIONE ALLA PRODUZIONE

Made in Ponzio: è questo il grande valore dei portoncini d'ingresso Bugnall, progettati e prodotti direttamente a “casa” Ponzio.

Nel 1941, da un'intuizione di Giuseppe Ponzio, nasce l'azienda omonima specializzata nel trattamento superficiale dell'alluminio. In questi oltre 70 anni di attività, Ponzio si è conquistata a ragione il titolo di leader assoluta nella progettazione, produzione e innovazione dei sistemi in alluminio per l'architettura con una filosofia aziendale orientata alla ricerca tecnologica, all'innovazione e alla fornitura del servizio, oltre che del prodotto. I portoncini Bugnall sono frutto di esperienza e capacità ma anche di studio continuo, oltre che di lungimiranti piani di investimento. È nato così lo stabilimento di produzione Bugnall, fiore all'occhiello del quartier generale Ponzio: oltre 60mila metri quadrati coperti nella zona industriale di Pineto.

THE “HOMEMADE” DOORS: FROM DESIGN TO MANUFACTURING

Made in Ponzio: this is the great value of the entry Bugnall doors, directly designed and produced at Ponzio “home”.

In 1941 Giuseppe Ponzio founded the eponymous company specializing in the surface treatment of aluminum. In these 70 years of activity, Ponzio has earned the title of the absolute leader in the design, manufacture and innovation of aluminum systems for architecture with a corporate philosophy oriented to technological research, innovation and service, over that of the product. The doors Bugnall are the result of experience and ability but also of ongoing study, as well as forward-looking investment plans. So it is born the factory of Bugnall in the Ponzio headquarters: over 60 thousand square meters covered in the industrial area of Pineto.



Certificate of Excellence
Certificato di Eccellenza
N° 261



AUTENTICITÀ

L'autenticità è un valore. E Bugnall crede, sostiene e pratica fortemente questo valore nei portoncini d'ingresso che realizza. Il lavoro manuale, la precisione, l'unicità di ogni pezzo prodotto sono parti integranti della tradizione dell'azienda Ponzio e tutto ciò conferisce un valore aggiunto al pannello Bugnall, assicurando un plus in termini di risultato finale. Dietro ogni porta d'ingresso ci sono esperienza, tradizione e storia di qualità: in una parola, autenticità. E l'autenticità del portoncino Bugnall è certificata su ogni imballo. Struttura e tecnologia, processi di lavorazione e materiali sono stati testati da prestigiosi Istituti nazionali che ne hanno attestato il valore garantendo prestazioni e caratteristiche. A completare la filosofia Ponzio, ci sono il forte legame con il territorio e il rispetto dell'ambiente, tanto da essere stata tra le prime aziende in Italia ad avere la certificazione "Emas ISO 14001".

AUTHENTICITY

Authenticity is a value. Bugnall believe and strongly practice this value in the entry doors that realizes. Manual work, precision and the uniqueness of each piece are integral parts of the tradition of Ponzio and everything adds value to the Bugnall panels, ensuring a plus in terms of the end result. Behind every door there are experience, tradition and history of quality: in a word, authenticity. And the authenticity of the Bugnall door is certified on all packaging. Structure and technology, manufacturing processes and materials have been tested by prestigious national institutes that have certificate guaranteeing the value and performance characteristics. To complete Ponzio philosophy, there are the strong bond with the land and the environment, so that it has been among the first companies in Italy to have the certification "Emas ISO 14001".



PORTONCINI NATURALMENTE ECOLOGICI

Leggerezza e design danno vita ad una perfetta sintonia, quella che nasce dall'incontro tra passato e futuro, esperienza e know-how, MDF e PIR.: le due linee di prodotto a marchio Bugnall. La leggerezza del PIR., il più utilizzato nelle realizzazioni edili per la sua facilità di utilizzo ed estrema resistenza, si sposa con l'Anima Flessibile e le nuove frontiere del poliuretano, il POL. I portoncini Bugnall sono tutti modelli depositati, unici e originali. La tecnologia potenzia le prestazioni. Le prestazioni garantiscono sicurezza. Ponzio lo certifica.

L'importanza del legame con il territorio e il rispetto dell'ambiente fanno parte della filosofia Ponzio, tanto da essere tra le prime aziende in Italia ad essere stata certificata "Emas ISO 14001".

NATURALLY ECOLOGICAL DOORS

Lightness and design create a perfect harmony, the same that born from the encounter between past and future, experience and know-how, MDF and PIR: the two product lines branded Bugnall. The lightness of the PIR, the most used in construction projects for its ease of use and extreme resistance, is combined with the Flexible Inner and the new frontiers of the polyurethane, the POL.

The Bugnall doors are all registered models, unique and original. The technology enhances performance. The performance guarantee safety. Ponzio certifies it, realizing every day products that contain the best also in ecological terms. Ponzio also means love for the land and the environment, as demonstrated by the fact that this is actually one of the first companies in Italy to have the certification "Emas ISO 14001".



H.I. ANIMA FLESSIBILE: PANNELLI DA GRANDI PERFORMANCE

Portoncini d'ingresso che non temono l'acqua e il vento, che isolano dal caldo, dal freddo e dai rumori. Sicurezza, clima, silenzio: il comfort è un valore che Bugnall mette al primo posto. Da oggi, inoltre, con la nuova tecnologia e l'inserimento dell'anima flessibile, i pannelli in alluminio Bugnall limitano il fenomeno della dilatazione termica, derivante dall'irraggiamento solare.

H.I. FLEXIBLE CORE: HIGH PERFORMING PANELS

Wind and waterproof entry doors, heat, cold and noises insulating. Safety, comfort, peace are Bugnall's first values. Today Bugnall aluminum panels, with their new technology and flexible core, reduce the effects of the thermal expansion due to sunlight.

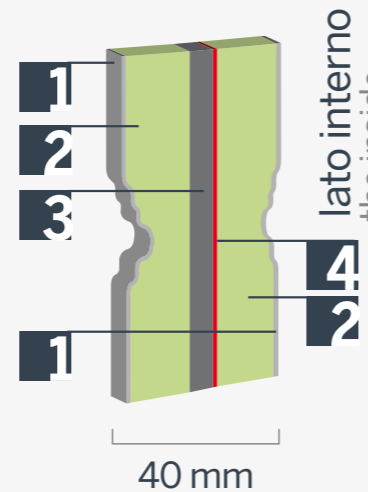
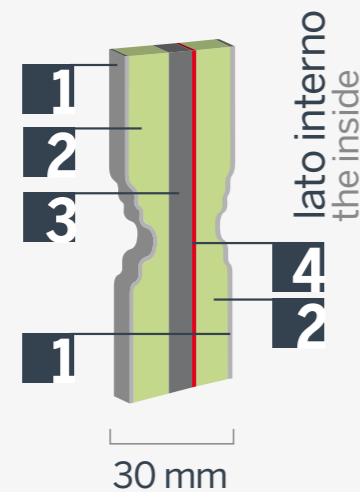
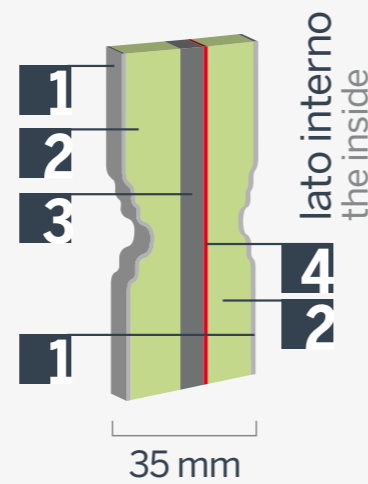
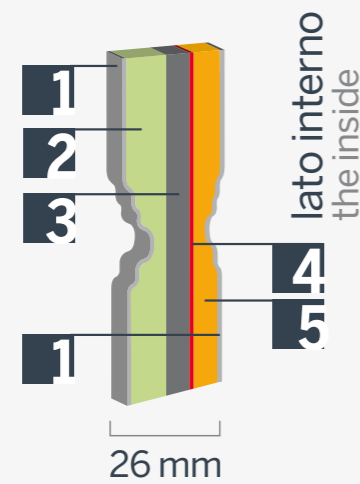

LEGENDA | LEGEND

- 1** Lamiera in alluminio 1,2 mm
Aluminum sheet 1,2 mm
- 2** Poliuretano isolante HD
Polyurethane non-conducting HD
- 3** Anima flessibile H.I.
Flexible core H.I.
- 4** Lamiera in alluminio 0,4 mm
(trattamento anti corrosione)
Aluminum sheet 0,4 mm
anticorrosion treatment
- 5** M.D.F.
M.D.F.

GAMMA IN P.I.R.

I pannelli in PIR offrono eccezionali garanzie:

- eccellente isolamento termico;
- stabilità dimensionale alle alte e basse temperature;
- isolamento acustico;
- idrorepellenza;
- leggerezza.

P.I.R. PANELS

P.I.R. panels can offer great performances:

- excellent thermal insulation;
- dimensional stability against high and low temperature;
- acoustic insulation;
- water repellency;
- lightness.

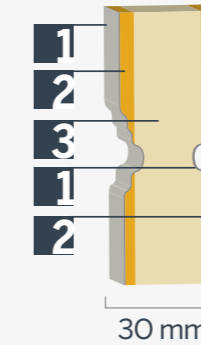
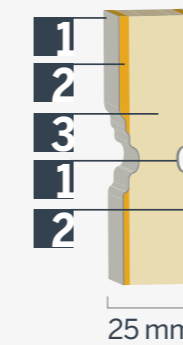

LEGENDA | LEGEND

- 1** Lamiera in alluminio 1,2 mm
Aluminum sheet 1,2 mm
- 2** M.D.F.
M.D.F.
- 3** Poliuretano isolante
Polyurethane non-conducting

GAMMA IN P.O.L. P.O.L. PANELS

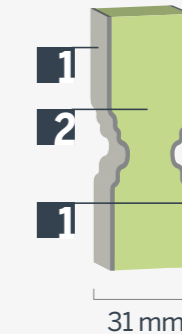
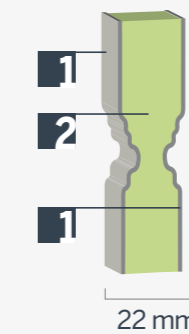
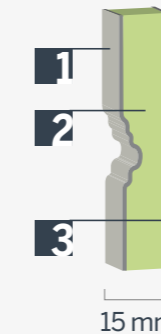
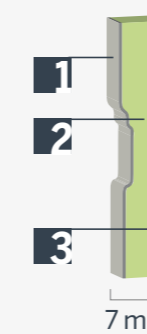

Leggerezza e grandi prestazioni tecniche per il pannello in P.O.R., poliuretano ad alta densità, che sposa leggerezza e resistenza.

Lightness and high performances for the P.O.L. range of panels, made of high density polyurethane, combine lightness and strength.

LEGENDA | LEGEND

- 1** Lamiera in alluminio 1,2 mm
Aluminum sheet 1,2 mm
- 2** Poliuretano isolante HD
Polyurethane non-conducting HD
- 3** Lamiera in alluminio 0,4 mm
(trattamento anti corrosione)
Aluminum sheet 0,4 mm
anticorrosion treatment



GAMMA IN M.D.F.

I pannelli in M.D.F. garantiscono la robustezza, solidità e resistenza delle strutture oltre ad assicurare buone qualità di idrorepellenza.

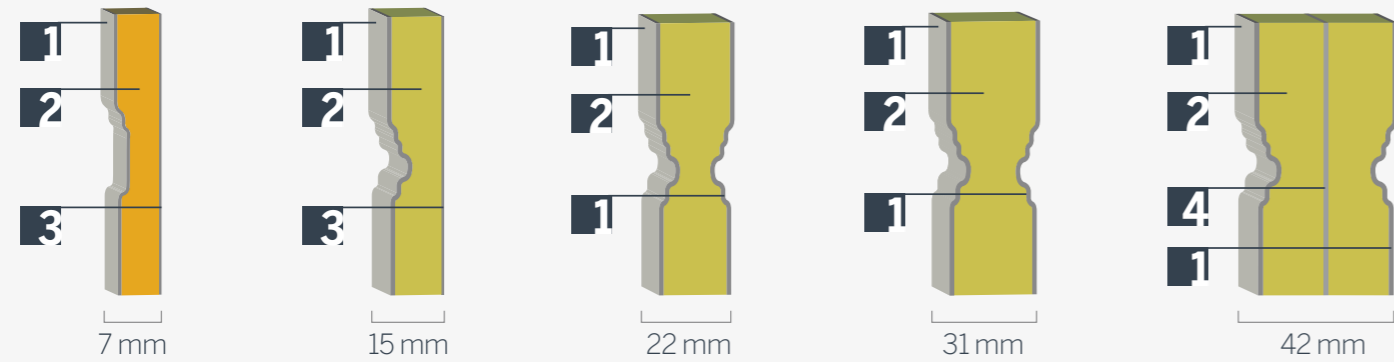

LEGENDA | LEGEND

- 1** Lamiera in alluminio 1,2 mm
Aluminium sheet 1,2 mm
- 2** MDF
MDF
- 3** Lamiera in alluminio 0,4 mm (trattamento anti corrosione)
Aluminium sheet 0,4 mm | anticorrosion treatment
- 4** Lamiera in acciaio zincato 1,0 mm
Aluminium sheet galvanized 1,0 mm

TABELLA PESI
WEIGHT TABLE

(riferito al pannello cieco)
(only for blind panel)

SPESORE THICKNESS	COMPOSIZIONE COMPOSITION	PESO WEIGHT
7 mm	M.D.F.	9,60 Kg/m ²
15 mm	M.D.F.	15,80 Kg/m ²
22 mm	M.D.F.	24,40 Kg/m ²
31 mm	M.D.F.	31,50 Kg/m ²
42 mm	M.D.F. lastra in acciaio steel plate	56,00 Kg/m ²
25 mm	P.I.R.	17,40 Kg/m ²
30 mm	P.I.R.	18,20 Kg/m ²
26 mm	H.I. MDF/POL	23,00 Kg/m ²
30 mm	H.I. POL/POL	18,70 Kg/m ²
35 mm	H.I. POL/POL	19,50 Kg/m ²
40 mm	H.I. POL/POL	20,30 Kg/m ²
7 mm	P.O.L.	7,40 Kg/m ²
15 mm	P.O.L.	8,40 Kg/m ²
22 mm	P.O.L.	12,10 Kg/m ²
31 mm	P.O.L.	13,60 Kg/m ²

M.D.F. PANELS

M.D.F. panels grant strength, solidity and resistance of its body and good water repellency performances.

MISURE PANNELLI
SIZE PANELS

STANDARD STANDARD	cm 90x215
FUORI MISURA VERNICIATO OVERSIZE PAINTED	cm MAX 100x250
TINTA LEGNO PAINT WOOD	cm MAX 100x220
FUORI MISURA MAX. OVERSIZE MAX.	SOLO TINTA LEGNO UBERALL ONLY UBERALL cm 100x250

SPESORE (mm)
THICKNESS (mm)

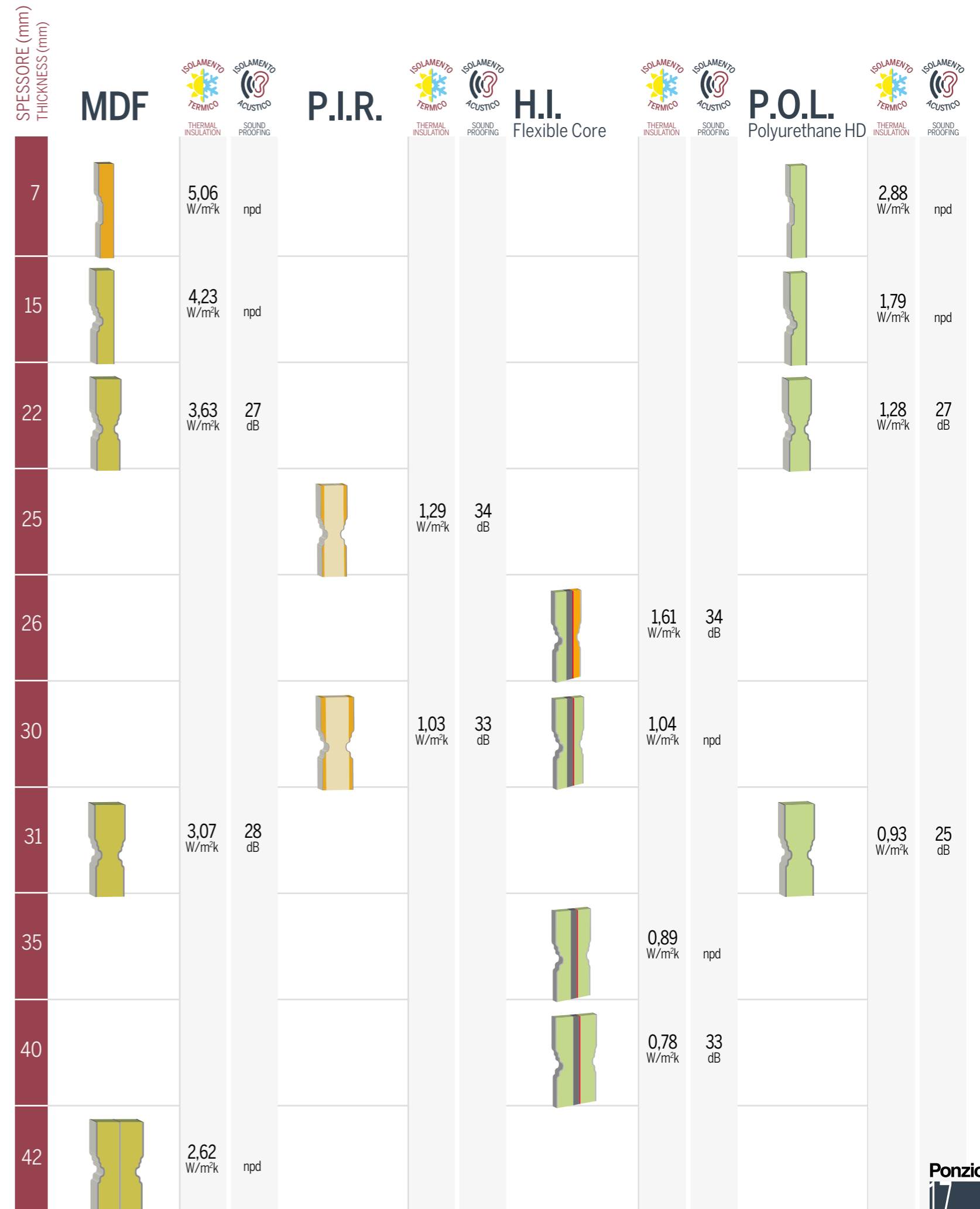

GAMMA VETRI GLASSES RANGE

LINEA TIFFANY

Il vetro è costituito da una lastra esterna da 4 mm basso emissiva magnetronica temperata, una camera d'aria di 12 - 15 - 18 mm creata mediante un distanziatore Super Spacer, una lastra interna stratificata 6/7 - 10/11. All'interno del pacchetto così costituito viene posta una lastra Tiffany interamente realizzata a mano con vetri colorati legati al piombo che danno carattere di esclusività al prodotto finale. Piccole imperfezioni della lastra Tiffany ne attestano la lavorazione manuale.

TIFFANY LINE

Its glass is composed of a 4mm low emissive magnetron temperate external pane, a 12-15-18 mm insulating double glass made through a Super Spacer and a 6/7 mm - 10/11 mm laminated internal pane. A Tiffany pane, entirely hand-made using colored lead up glasses, is carefully inserted making an exclusive final product. The little imperfections of the Tiffany pane certify their hand-made production process.

COMPOSIZIONE COMPOSITION	ISOLAMENTO TERMICO THERMAL INSULATION
4t - 18 - 10/11 be 4t - 15 - 6/7 be 4t - 12 - 6/7 be	Ug = 1,1 W/m ² k Ug = 1,1 W/m ² k Ug = 1,6 W/m ² k
SPESSORE THICKNESS	
32 mm 26 mm 22 mm	
APPLICABILE SU PANNELLO APPLICABLE ON PANEL	
Sp. 40 mm Sp. 35 mm Sp. 30 mm	Sp. 22 mm* * solo per i modelli disponibili con cornice fermavetro



LINEA TIFFANY
TIFFANY LINE

LINEA SATINATO

Il vetro è costituito da lastra esterna stratificata 6/7 mm satinata, una camera d'aria di 9 - 12 - 18 mm e una lastra interna stratificata 6/7 mm trasparente.

SATIN LINE

Its glass is made of a 6/7 mm laminated satin external pane, a 9-12-18 mm insulating double glass and a 6/7 mm clear laminated internal pane.

COMPOSIZIONE COMPOSITION
6/7 - 18 - 6/7 6/7 - 12 - 6/7 6/7 - 9 - 6/7
SPESSORE THICKNESS
32 mm 26 mm 22 mm
ISOLAMENTO TERMICO THERMAL INSULATION
Ug = 2,7 W/m ² k Ug = 2,8 W/m ² k Ug = 3,0 W/m ² k
APPLICABILE SU PANNELLO APPLICABLE ON PANEL
Sp. 40 mm Sp. 35 mm Sp. 30 mm Sp. 22 mm*
* solo per i modelli disponibili con cornice fermavetro



SATINATO
SATIN

LINEA VETROFUSIONE

Il vetro è costituito da una lastra esterna da 6 mm realizzata in fusione di elementi neutri e/o colorati, una camera d'aria di 9 - 12 - 18 mm creata mediante un distanziatore Super Spacer e una lastra interna basso emissiva 6/9 - 8/9. Le lastre in vetrofusione vengono realizzate singolarmente per garantire l'esclusività e l'unicità del prodotto finale. Piccole imperfezioni sono garanzia di un prodotto realizzato a mano.

GLASS FUSING LINE

Its glass is made of a 6mm external pane made by fusion of neutral and/or colored pieces, a 9-12-18 mm insulating double glass made through a Super Spacer, an internal 6/9 - 8/9 mm low emissive pane. Each fused pane is made one by one making each product a unique and exclusive masterpiece. The little imperfections of the Tiffany pane certify their hand-made production process.

COMPOSIZIONE COMPOSITION	ISOLAMENTO TERMICO THERMAL INSULATION
8/9 be - 18 - 6 vf 6/7 be - 12 - 6 vf 6/7 - 9 - 6 vf	Ug = 1,1 W/m ² k Ug = 1,6 W/m ² k Ug = 1,9 W/m ² k
SPESSORE THICKNESS	
32 mm 26 mm 22 mm	
APPLICABILE SU PANNELLO APPLICABLE ON PANEL	
Sp. 40 mm Sp. 35 mm Sp. 30 mm	Sp. 22 mm* * solo per i modelli disponibili con cornice fermavetro



VETRO FUSIONE
GLASS FUSING LINE



NUOVA CORNICE FERMAVETRO: LA PERFEZIONE DELLE BUGNE È PER NOI UN DOVERE. PER VOI UN PIACERE

Due in uno: bello alla vista e coplanare al tatto. Si sposano alla perfezione i valori tecnici ed estetici della nuova cornice fermavetro. Un nuovo plus di casa Bugnall, la cornice in estruso di alluminio interna ed esterna, perfettamente integrata al pannello. Le due sezioni della stessa vengono assemblate sul pannello tramite un sistema di aggancio in acciaio inox a contrasto. Le guarnizioni garantiscono la tenuta sia sul vetro che sul pannello. Sicurezza e facilità di montaggio le immediate conseguenze a vantaggio del pannello Bugnall. Questo importantissimo upgrade tecnico aiuta la cornice a riprendere perfettamente, nella forma e nella dimensione, la bugna storica dei pannelli ciechi. La cornice si integra al pannello sul quale viene effettuato il ribassamento e l'effetto finale è gradevole nella coplanarità della cornice rispetto al pannello.

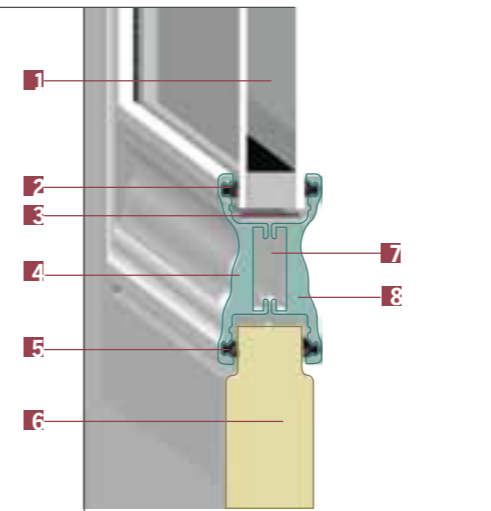

CORNICE COMPLANARE | FLUSH WITH THE FRAME

- LEGENDA | LEGEND
- 1 Vetro
Glass
 - 2 Guarnizione vetro
Glass garnish
 - 3 Tassello vetro
Glass dowel
 - 4 Cornice fermavetro in alluminio
(lato interno)
Aluminum glazing frame
(the inside)
 - 5 Guarnizione pannello
Seal panel
 - 6 Pannello con ribassamento
(spessore mm 30,31,35,40)
Panel with lowering
(thickness mm 30,31,35,40)
 - 7 Sistema di aggancio in acciaio inox
a contrasto
Compling system in stainless steel in contrast
 - 8 Cornice fermavetro in alluminio
(lato esterno)
Aluminum glazing frame (the outside)

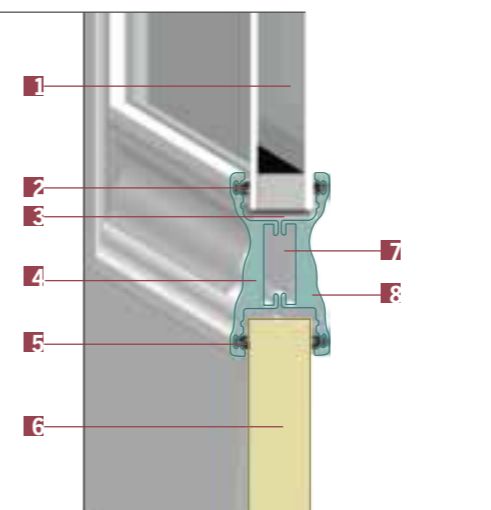

NOVITÀ | NEWS: THICKNESS 22 MM PANNELLO VETRATO SPESSORE 22 MM.

- LEGENDA | LEGEND
- 1 Vetro
Glass
 - 2 Guarnizione vetro
Glass garnish
 - 3 Tassello vetro
Glass dowel
 - 4 Cornice fermavetro in alluminio
(lato interno)
Aluminum glazing frame
(the inside)
 - 5 Guarnizione pannello
Seal panel
 - 6 Pannello (spessore mm 22)
Panel (thickness mm 22)
 - 7 Sistema di aggancio in acciaio inox
a contrasto
Compling system in stainless steel in contrast
 - 8 Cornice fermavetro in alluminio
(lato esterno)
Aluminum glazing frame (the outside)

NEW GLAZING BEAD FRAME: THE PERFECTION OF THE SHAPES IS A DUTY FOR US, A PLEASURE FOR YOU

Two in one: beautiful to the eye and coplanar to the touch. Aesthetic and technical values of the new glazing bead frame perfectly combine together. The internal and external aluminum extruded frame are perfectly integrated with its panel: a new "plus" of Bugnall. Two frame sections are assembled on the panel through a stainless steel coupling system. The gaskets guarantee the grip both on the glass and on the panel. So Bugnall becomes safer and easier to install. This important technical upgrade make the glazing bead frame to be similar in the dimension and in the form to the historical shape of the blinded panels. A pleasant coplanarity between the frame and the door panel that are appropriately integrated each other.



**APRI ALLA STORIA
DEI PORTONCINI
D'INGRESSO:
BUGNALL TI ASPETTA.**

Bugnall è lo storico brand di portoncini d'ingresso in alluminio bugnato che apre al futuro con il nuovo programma "Ponzio Pannelli".

Ricercato nelle linee prominenti che si ispirano alla tradizione, il portoncino Bugnall presenta le novità che sono la sintesi di ricerca continua e tecnologia avanzata.



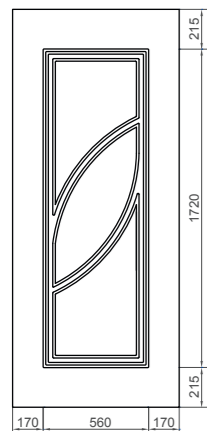

UENO 1101

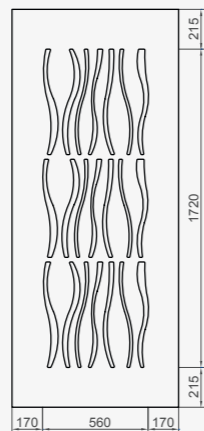

BABILA 1102

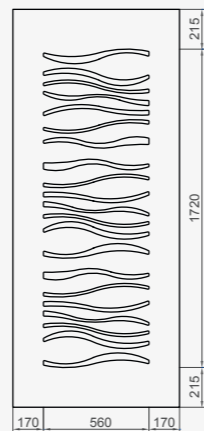

CLOTILDE 1103

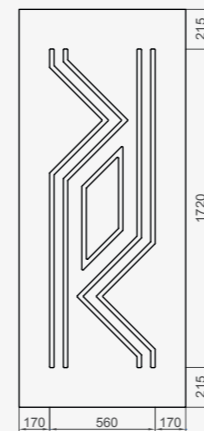

GINZA 1104

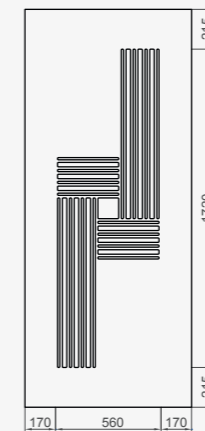

BROOKLYN 1105

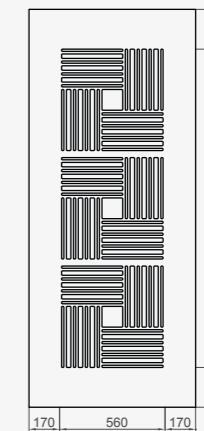

GREENWICH 1106



Rovere 25

UENO 1101

Maniglione BU 1044
LUNA
Cromo Satinato

Rosette BU 1414
Cromo Satinato



Ral 9002

BABILA 1102

Maniglione BU 2364
ZEN
Cromo Satinato



Ral 7035

CLOTILDE 1103

Maniglione BU 3468
RAIN 600
Acciaio inox



Noce 41

GINZA 1104

Maniglione BU 344
SOCRATE
Cromo Satinato



Ral 9001

BROOKLYN 1105

Pomolo BU 5029
FISSO
Cromo Satinato



Ral 9003

GREENWICH 1106

Maniglione BU 3678
MAGNETIC
Acciaio Inox AISI 316L



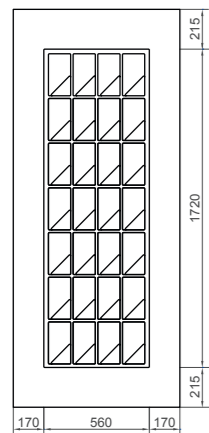

CARDUSIO 1107

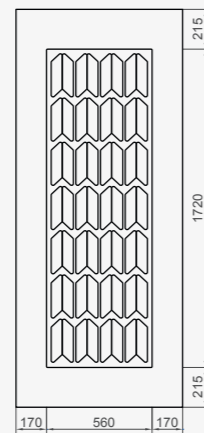

NAVONA 1108

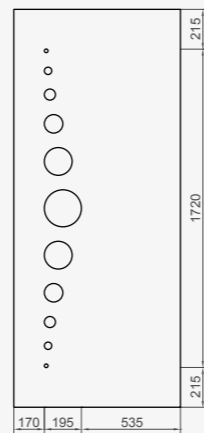

LUSTGARTEN 1109

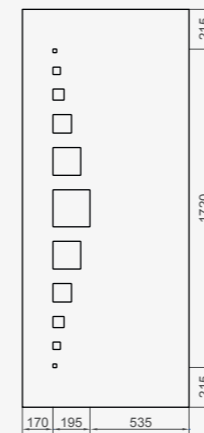

SHIBUYA 1110

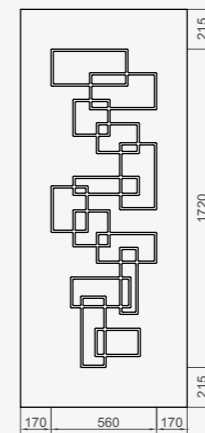

MINERVA 1111

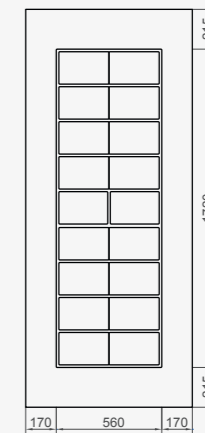

DARLING 1112



Ral 1014

CARDUSIO 1107

Maniglione BU 3598DX
TWINS
Acciaio Inox



Ral 1015

NAVONA 1108

Maniglione BU 3639
SNOW 300
STAROX



Ral 1013

LUSTGARTEN 1109

Maniglione BU 3648
TRENDY
Acciaio Inox AISI 316L



Ral 5015

SHIBUYA 1110

Maniglione BU 3738
LUXURY
Acciaio Inox AISI 316L



Ral 7001

MINERVA 1111

Maniglione BU 3585
PUNTATOTE NERO
Acciaio Inox AISI 316L



Ral 7038

DARLING 1112

Maniglione BU 3608
FASHION
Acciaio Inox AISI 316L



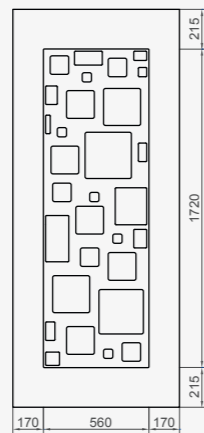

MITTE 1113

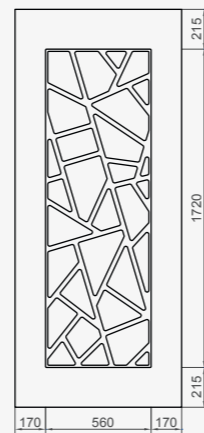

SAMARCANDA 1114



Ral 6005

MITTE 1113



Ral 1014

SAMARCANDA 1114

Maniglione BU 3529
WARM 250
Starox



Maniglione BU 3668
VIP
Acciaio Inox AISI 316L



NUOVI MODELLI

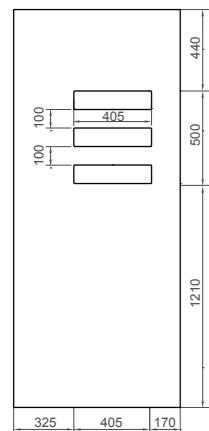

MONACO 1120

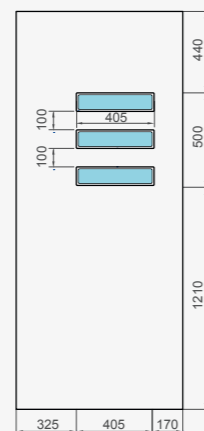

MONACO 1125

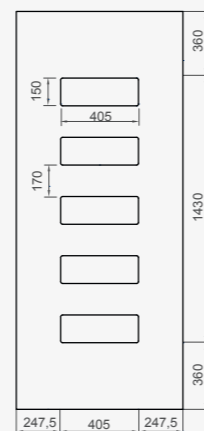

ISTANBUL 1130

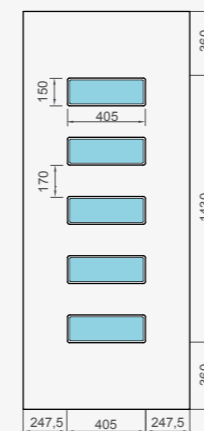

ISTANBUL 1135

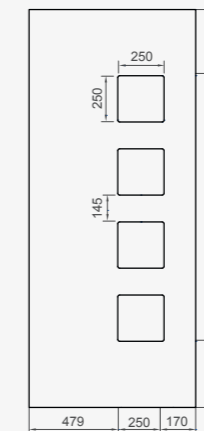

TORONTO 1140

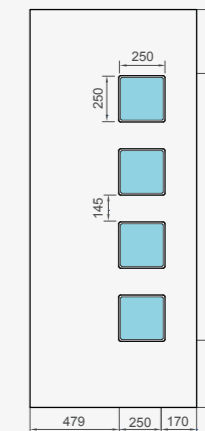

TORONTO 1145



Ral 7037

MONACO 1120
Bugna esterna 3D

Maniglione BU 3438
RAIN
Acciaio Inox



Ral 7038 / Satinato Bianco Bu 09916

MONACO 1125

Maniglione BU 3738
LUXURY
Acciaio Inox AISI 316L



Ral 7035

ISTANBUL 1130
Bugna esterna 3D

Maniglione BU 3545
WARM 400
Neromat



Ral 9018 / Fuso Sabbiato Bu 09918

ISTANBUL 1135

Maniglione BU 3588
PUNTATORE
Acciaio Inox AISI 316L



Rosetta BU 2498
Acciaio Inox AISI 316L



Ral 7001

TORONTO 1140
Bugna esterna 3D

Maniglione BU 3748
MOHICANO
Acciaio Inox AISI 316



Ral 9003

TORONTO 1145

Maniglione BU 3549
WARM 400
Starox





APRI AI PORTONI DEL TUO TEMPO: ENTRA NEL MONDO BUGNALL.

La linea di portoncini d'ingresso che grazie alla forza del suo passato guarda al futuro nella direzione del bello, della funzionalità della novità del quotidiano.

Forme regolari, sinuosità delle bugne, colori e tradizione si fondono nella Linea Classic per aprire ad un nuovo modo di vivere il tempo della tua vita.

BUGNALL[®]
IL PORTONCINO CHE TI ASPETTA

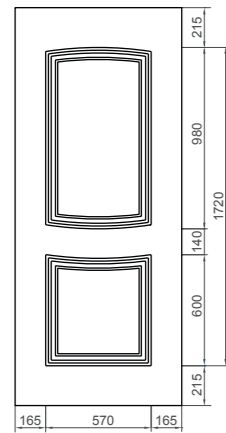

ARSENAL 0100

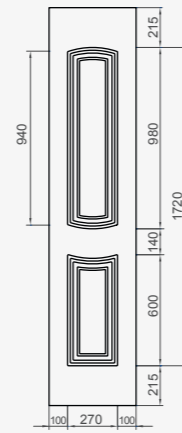

GREENFORD 0110

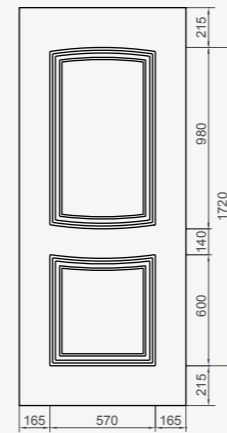

ARSENAL 0100

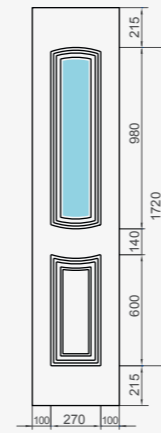

GREENFORD 0115

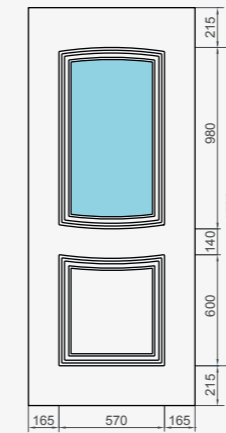

ARSENAL 0105

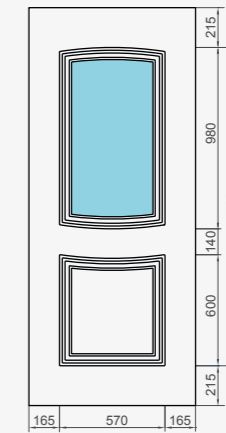

ARSENAL 0105



ARSENAL 0100

Ral 7037

Maniglione BU 482
DIOCLEZIANO
T.O.R.



Ral 7001

GREENFORD 0110 / ARSENAL 0100

Battente BU 302
ANELLO
T.O.R.



Maniglione BU 352
CESARE
T.O.R.



Ral 9018 / Tiffany Bu 09886 / Tiffany BU 09885

GREENFORD 0115 / ARSENAL 0105

Battente BU 362
AUGUSTO
T.O.R.



Ral 9016/ Tiffany 09810

ARSENAL 0105

Maniglione BU 3632
SNOW 300
T.O.R.



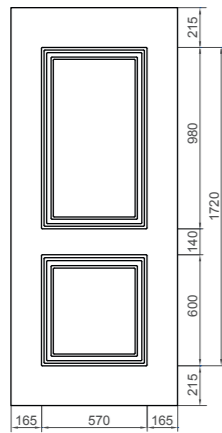

ASTON 0301

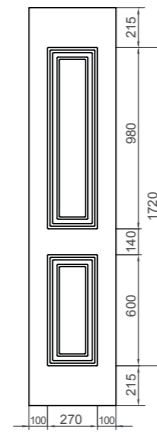

ASTON 0311

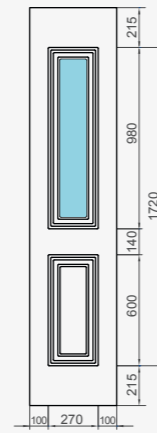

ASTON 0315

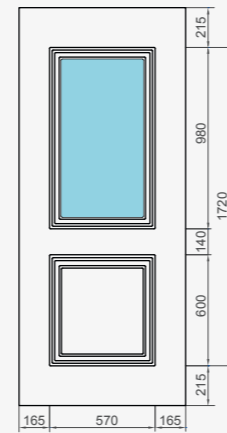

ASTON 0305

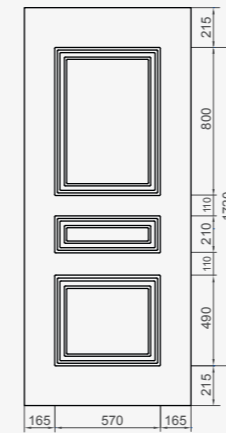

BOLTON 0302

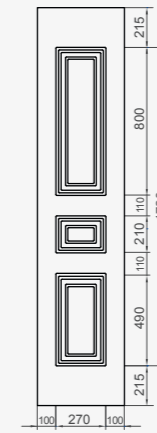

BOLTON 0303

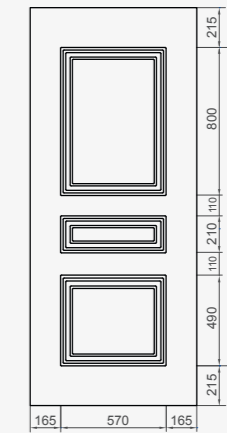

BOLTON 0302

NUOVO MODELLO



Ral 3005

ASTON 0301

Maniglione BU 432
ARCHIMEDE
T.O.R.



NUOVO MODELLO



Ral 3011 / Vetro Fusione BU 09733 / Vetro Fusione BU 09721

ASTON 0315 / 0305

Maniglione BU 3348
COOL 400
Acciaio Inox



NUOVO MODELLO



Ral 3014

BOLTON 0302

Maniglione BU 3522
WARM 250
T.O.R.



NUOVO MODELLO



Ral 3015

BOLTON 0303 / 0302

Maniglione BU 3542
WARM 400
T.O.R.



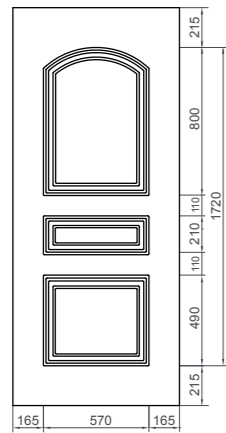

WEST 0322

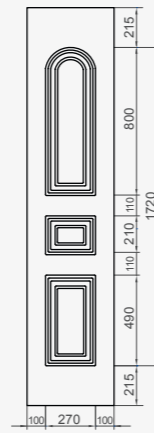

WEST 0321

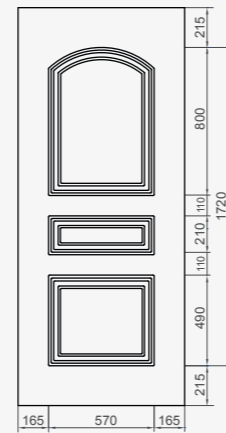

WEST 0322

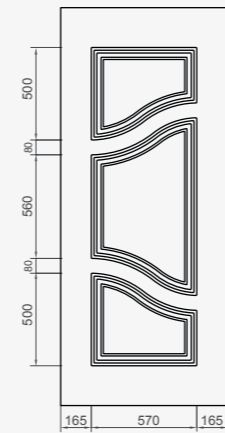

KENTON 0120SX

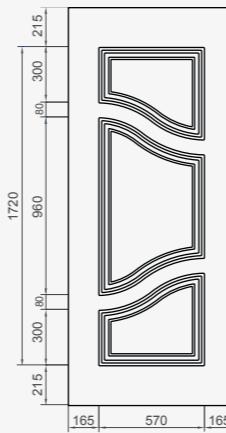

KENTON 0121DX

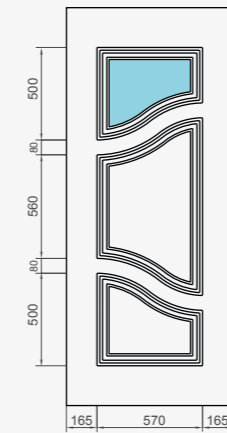

KENTON 0125SX

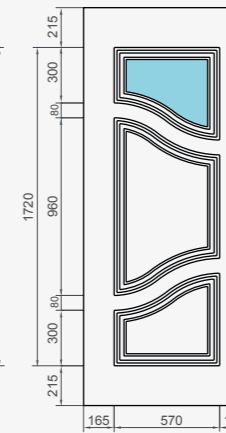

KENTON 0126DX

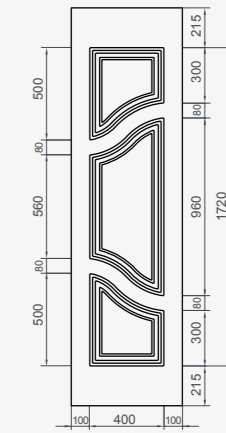

KENTON 0130SX

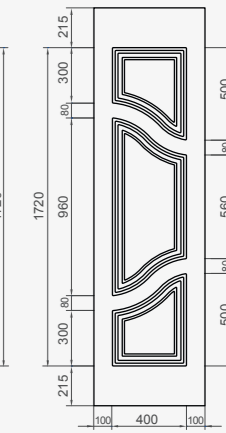

KENTON 0131DX

NUOVO MODELLO



WEST 0322

ral 6025

Maniglione BU 3829
HOT 250
Starox



NUOVO MODELLO



Ciliegio

WEST 0321 / 0322

Maniglione BU 3822
HOT 250
T.O.R.



Platano

KENTON 0120 / 0121

Maniglione BU 3632
SNOW 300
T.O.R.



Noce 41 / Tiffany BU 09830 sx / Tiffany BU 9840 dx

KENTON 0125 / 0126

Maniglione BU 3622
SNOW 200
T.O.R.



Wengè

KENTON 0130 / 0131

Maniglione BU 3635
SNOW 300
Neromat





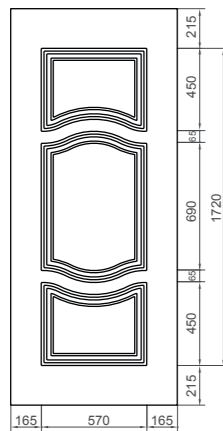

KENNINGTON 0160

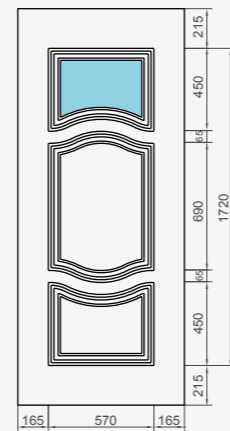

KENNINGTON 0165

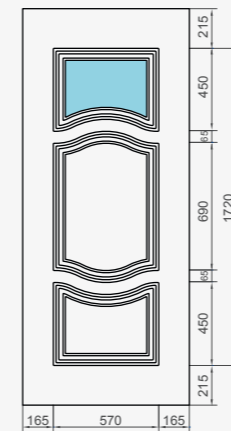

KENNINGTON 0165

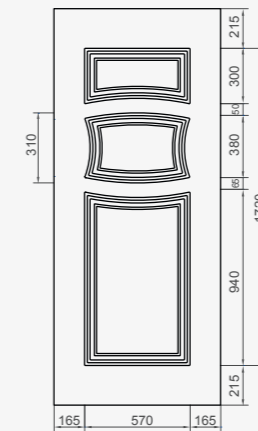

WEMBLEY 0140

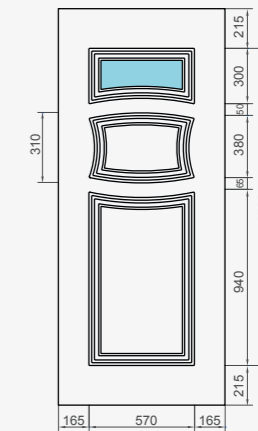

WEMBLEY 0145



KENNINGTON 0160

Ral 7038

Maniglione BU 1062
VENERE
T.O.R.



KENNINGTON 0165

Ral 7035 / Tiffany BU 09870

Maniglione BU 1064
VENERE
Cromo Satinato



KENNINGTON 0165

Ral 9002 / Tiffany BU 09874

Maniglione BU 1064
VENERE
Cromo Satinato



WEMBLEY 0140

Ral 9003

Maniglione BU 372
ARISTOTELE
T.O.R.



WEMBLEY 0145

Ral 9016 / Satinato Bianco BU 90459

Maniglione BU 2052
FLESSO
T.O.R.



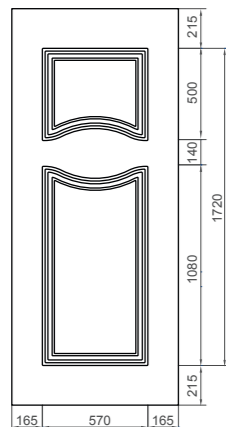

VICTORIA 0180



Ral 8004

VICTORIA 0180

Maniglione BU 3929
COLD 250
Starox



Battente BU 2164
Cromo Satinato

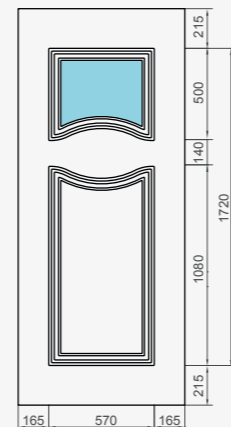

VICTORIA 0185



Ral 8023 / Satinato Bronzo BU 90469

VICTORIA 0185

Maniglione BU 3922
COLD 250
T.O.R.



Battente BU 2161
T.O.R.

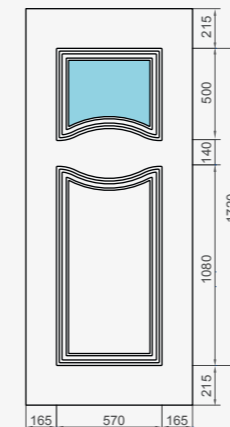

VICTORIA 0185



Ral 3015 / Satinato Bianco BU 90568

VICTORIA 0185

Maniglione BU 3929
COLD 250
Starox



Battente BU 2164
Cromo Satinato

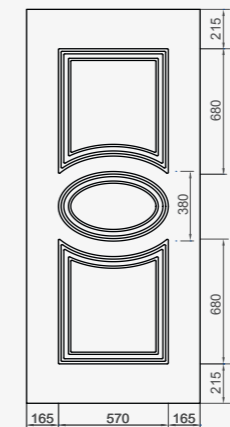

CARDIFF 0790



Ral 1011

CARDIFF 0790

Maniglione BU 1044
LUNA
Cromo Satinato

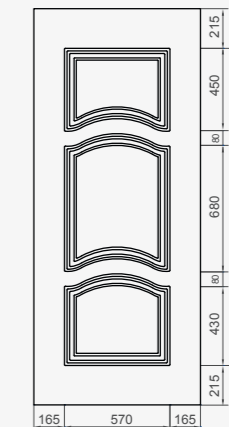

FARNESE 0161



Ral 1014

FARNESE 0161

Maniglione BU 3822
HOT 250
T.O.R.



NUOVO MODELLO

NUOVO MODELLO

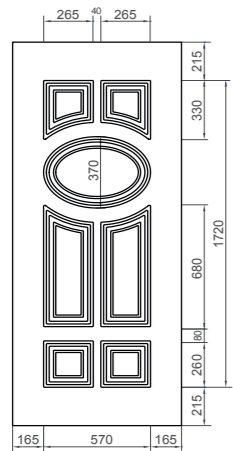

REGENT 0770

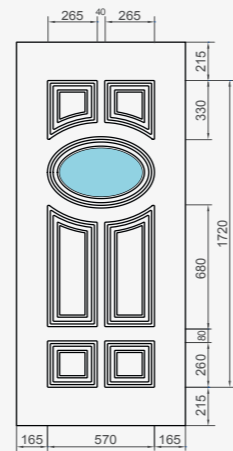

REGENT 0775

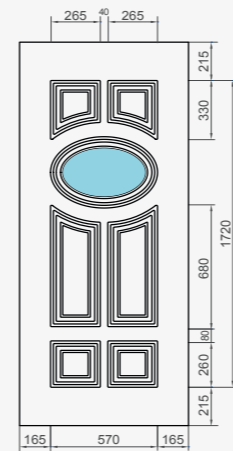

REGENT 0775

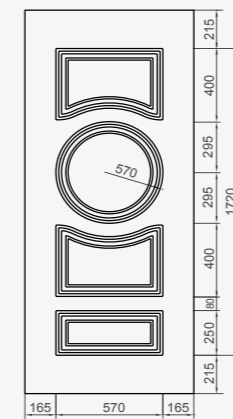

MADISON 0780

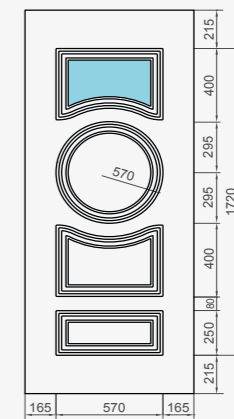

MADISON 0785



Ral 9002

REGENT 0770

Battente BU 662
FAGOTTO
T.O.R.



Maniglione BU 1062
VENERE
T.O.R.



Ral 7035 / Tiffany BU 09776

REGENT 0775

Maniglione BU 2052
FLESSO
T.O.R.



Ral 9001 / Tiffany BU 09770

REGENT 0775

Maniglione BU 3648
TRENDY
Acciaio Inox AISI 316L



Ral 9003

MADISON 0780

Maniglione BU 8402
GLADYS
T.O.R.



Ral 9016 / Tiffany BU 09874

MADISON 0785

Maniglione BU 8302
PRESTIGE
T.O.R.



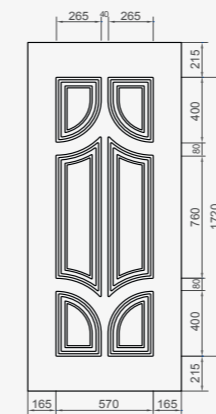
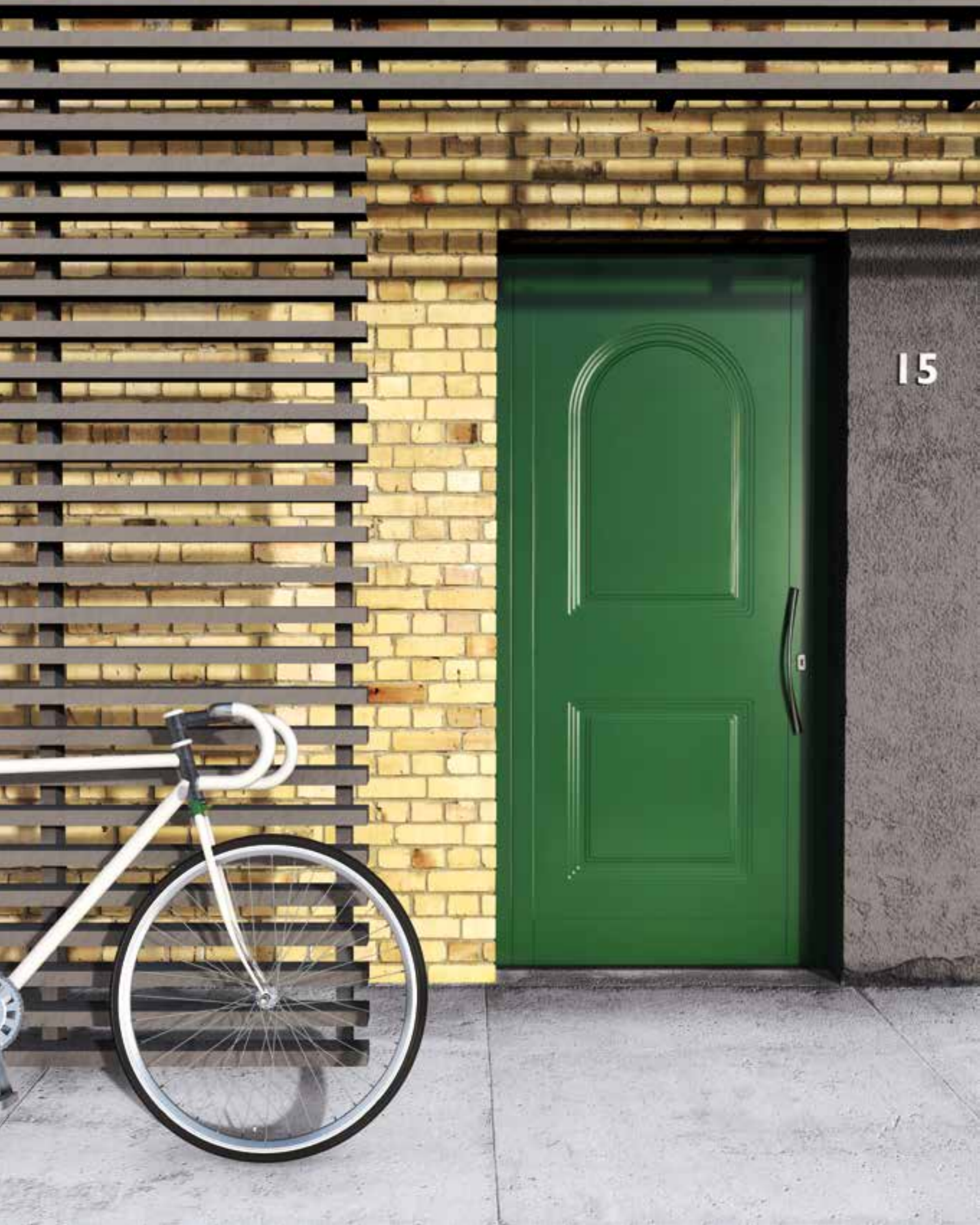

QUEENS 0630

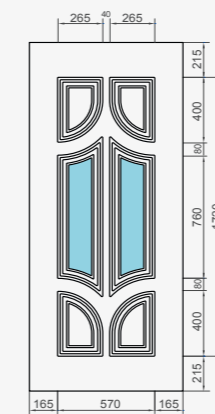

QUEENS 0635

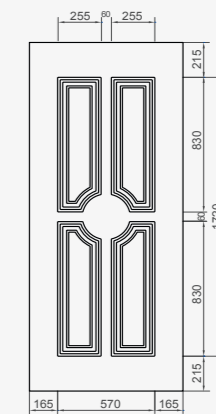

BRERA 0500



Ral 7001

QUEENS 0630



Noce 43 / Fuso Sabbiato BU 09749

QUEENS 0635



Platano 35

BRERA 0500

Maniglione BU 344
SOCRATE
Cromo Satinato



Maniglione BU 342
SOCRATE
T.O.R.



Battente BU 6629
Starox



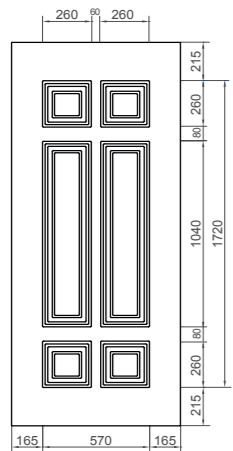

ORLANDO 0401

NUOVO MODELLO



Ral 6005

ORLANDO 0401

Maniglione BU 3605
FASHION
Nero Acciaio Inox AISI 316L

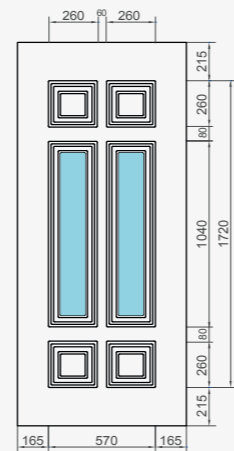

ORLANDO 0405

NUOVO MODELLO



Ral 1014 / Tiffany BU 09310

ORLANDO 0405

Maniglione BU 3608
FASHION
Acciaio Inox AISI 316L

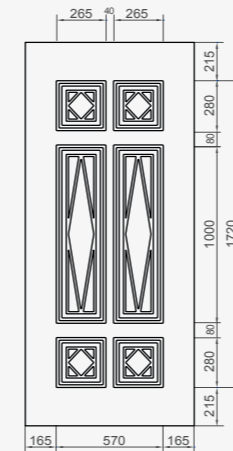

TRAFALGAR 0600



Ral 1015

TRAFALGAR 0600

Maniglione BU 3522
WARM 250
T.O.R.

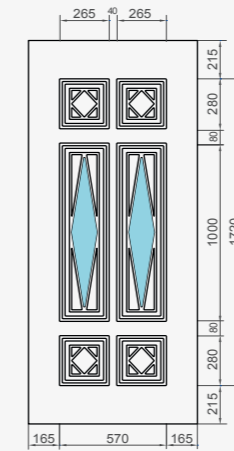

TRAFALGAR 0605



Ral 1013 / Tiffany BU 09316

TRAFALGAR 0605

Maniglione BU 3529
WARM 250
Starox

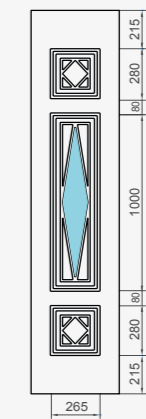

TRAFALGAR 0615



Ral 9003 / Vetro Fusione BU 09880

TRAFALGAR 0615

Maniglione BU 3585
PUNTATORE
Acciaio Inox AISI 316L



Rosette BU 2495
Acciaio Inox AISI 316L



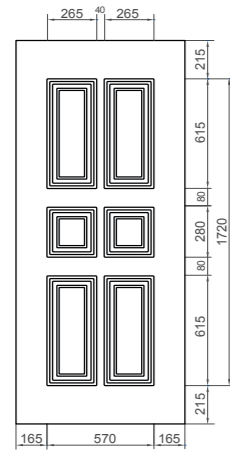

MANHATTAN 0800

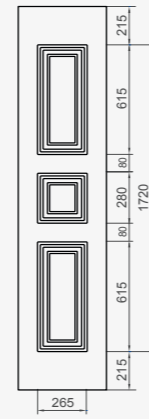

PIGALLE 0810

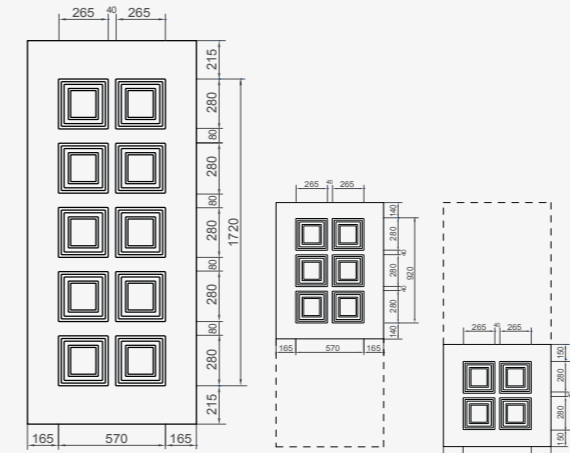

RIO 0300

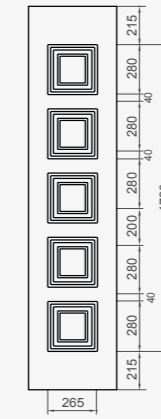

RIO 0350

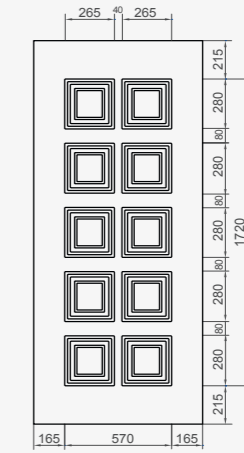

RIO 0300



Ral 5004

MANHATTAN 0800

Maniglione BU 3738
LUXURY
Acciaio Inox AISI 316L



Ral 7001

PIGALLE 0810

Maniglione BU 358811
PUNTATORE
Acciaio Inox AISI 316L Bianco



Rosette BU 249811
Acciaio Inox AISI 316L Bianco



Ral 7038

RIO 0300

Maniglione BU 3678
MAGNETIC
Acciaio Inox AISI 316L



Ral 9018

RIO 0350 / 0300

Maniglione BU 3605
FASHION
Acciaio Inox AISI 316L Nero



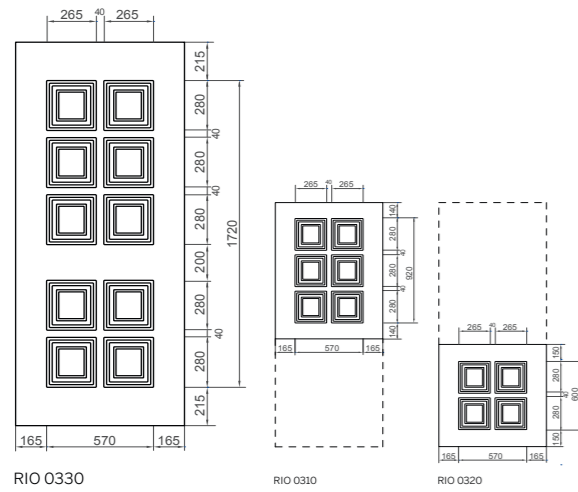

RIO 0330

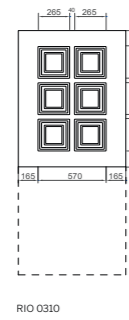

RIO 0310

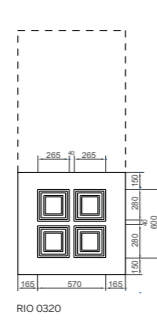

RIO 0320

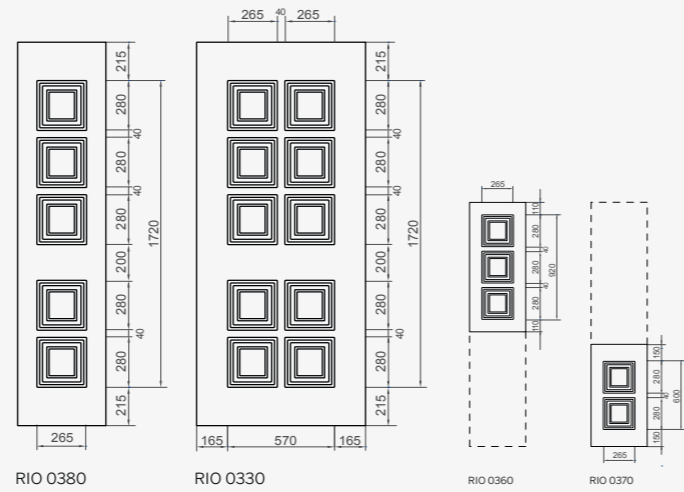

RIO 0380

RIO 0330

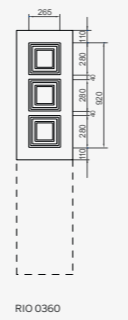

RIO 0360

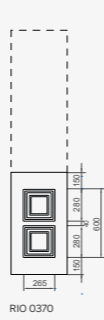

RIO 0370

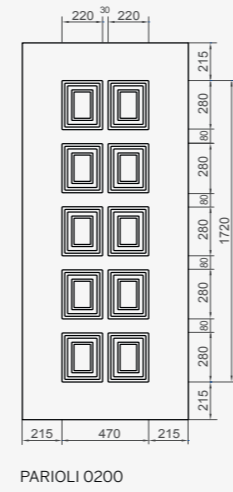

PARIOLI 0200

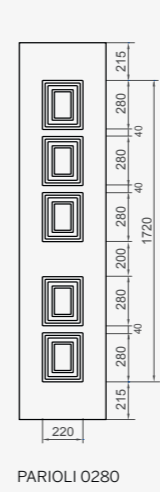

PARIOLI 0280

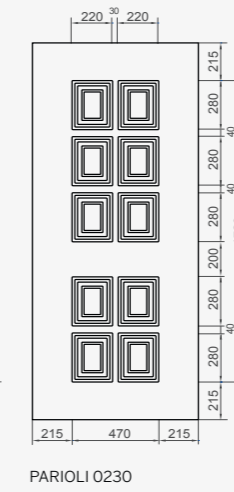

PARIOLI 0230

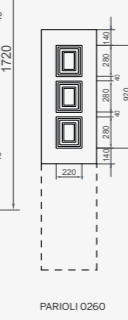

PARIOLI 0260

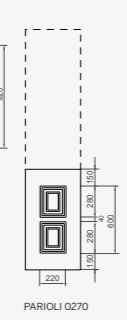

PARIOLI 0270

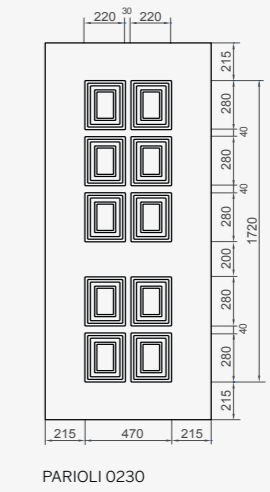

PARIOLI 0230

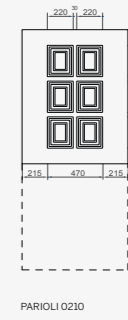

PARIOLI 0210

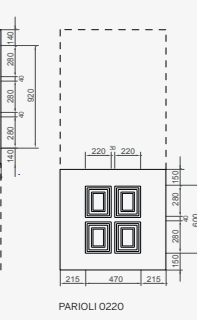

PARIOLI 0220



Ral 6025

RIO 0330

Maniglione BU 3632
SNOW 300
T.O.R.

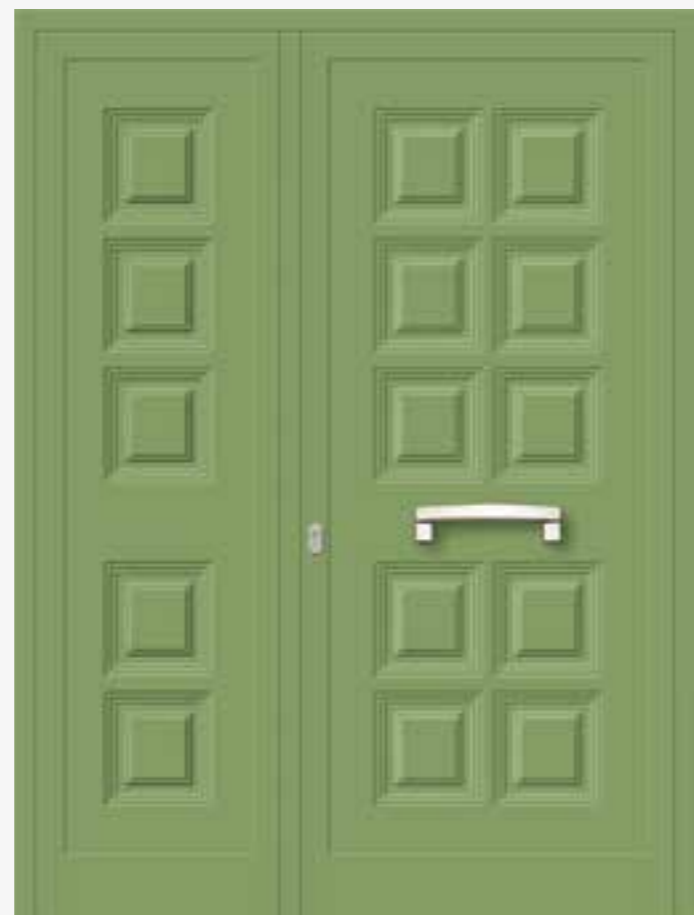

Ral 6021

RIO 0380 / 0330

Maniglione BU 3629
SNOW 200
Starox



Ral 1014

PARIOLI 0200

Maniglione BU 3588
PUNTATORE
Acciaio Inox AISI 316L
Rosette BU 2498
Acciaio Inox AISI 316L

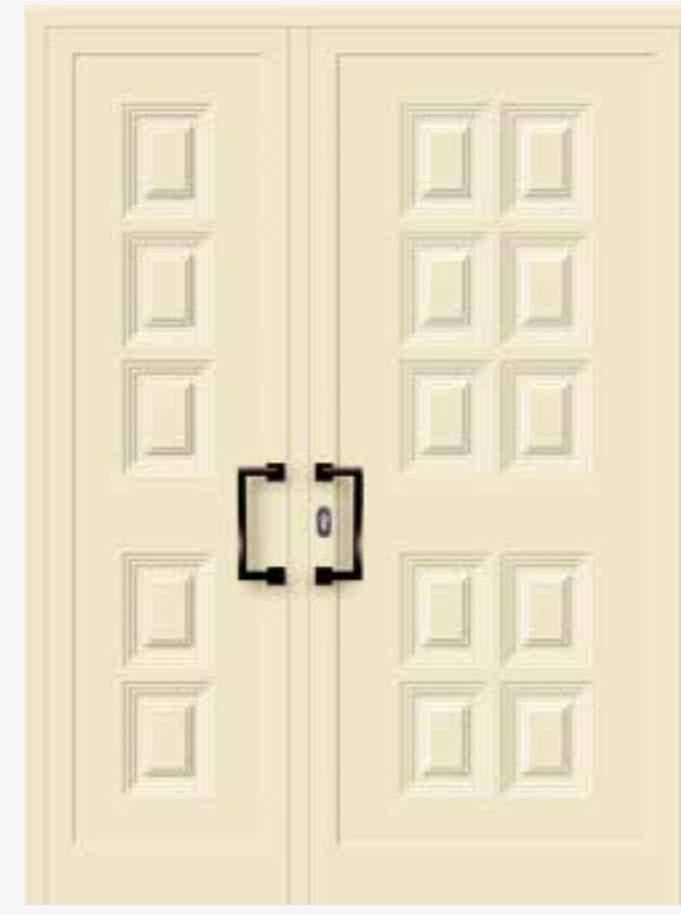

Ral 1013

PARIOLI 0250 / 0230

Maniglione BU 3585
PUNTATORE
Acciaio Inox AISI 316L Nero
Rosette BU 2495
Acciaio Inox AISI 316L



Ral 9003

PARIOLI 0230

Maniglione BU 3542
WARM 400
T.O.R.





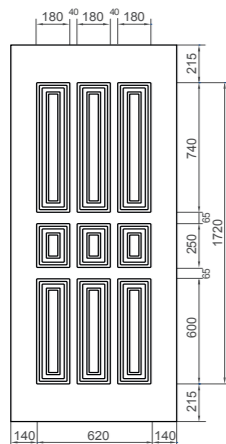

RAMBLAS 0400

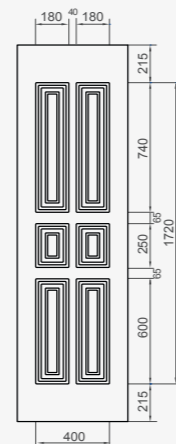

RAMBLAS 0410

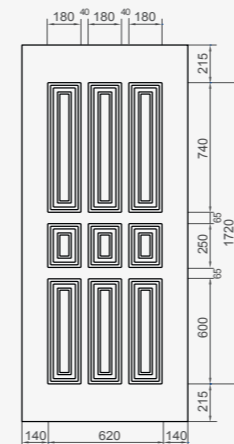

RAMBLAS 0400

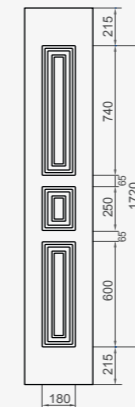

RAMBLAS 0420

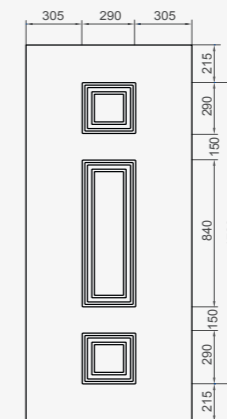

BARBERINI 0533

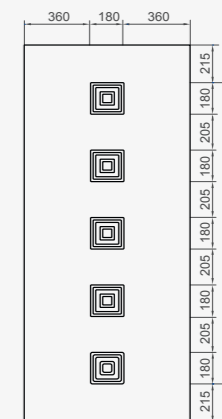

BELLINI 0532



Ral 5015

RAMBLAS 0400

Maniglione BU 3529
WARM 250
Starox

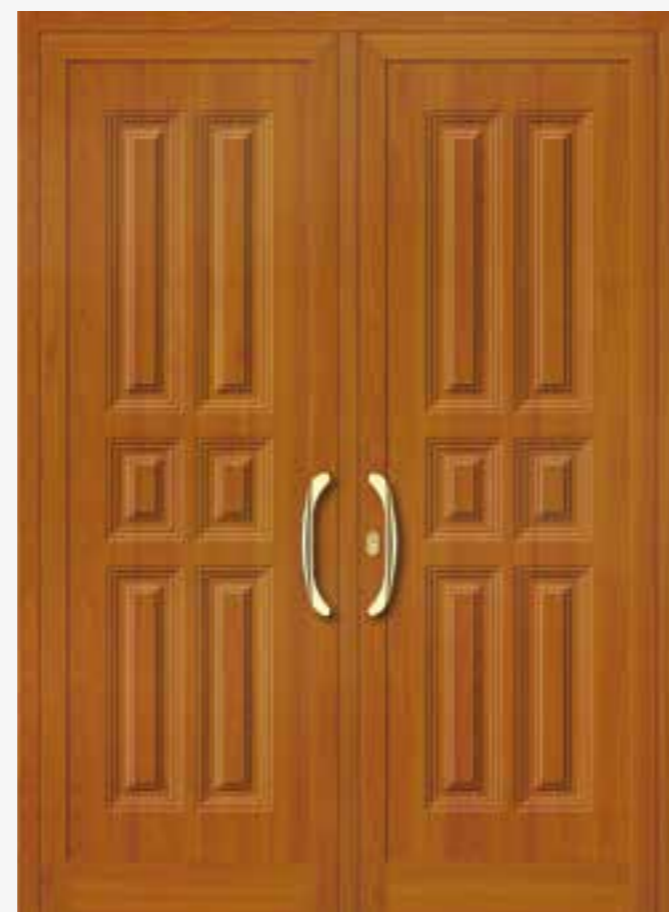

Ciliegio

RAMBLAS 0410

Maniglione BU 3522
WARM 250
T.O.R.



Renolit

RAMBLAS 0400 / 0420

Maniglione BU 3635
SNOW 300
Neromat



Noce 43

BARBERINI 0533

Maniglione BU 3388
COOL 800
Acciaio Inox



Noce 41

BELLINI 0532

Pomolo BU 5029
FISSO
Cromo Satinato



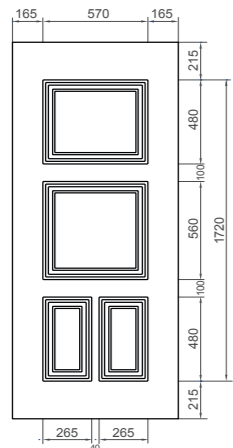

BROADWAY 0670

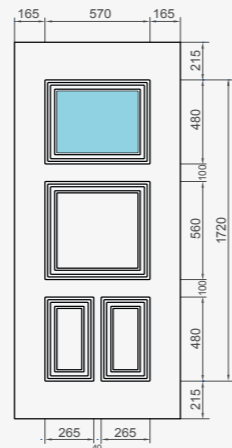

BROADWAY 0675

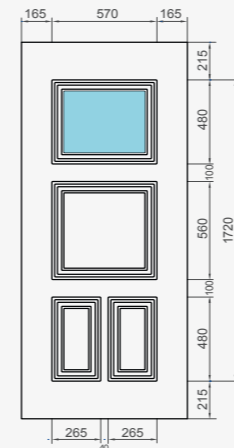

BROADWAY 0675

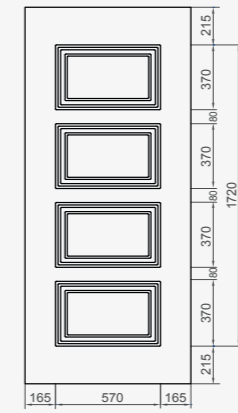

CRYSTAL 0536

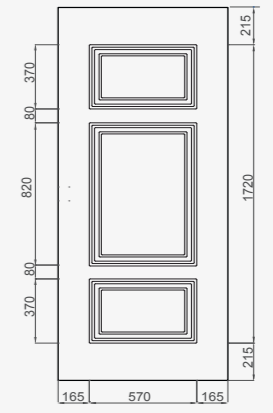

OXFORD 630



Ral 5009

BROADWAY 0670

Battente BU 744
Cromo Satinato



Maniglione BU 1064
VENERE
Cromo Satinato



Ral 5015 / Tiffany BU 09905

BROADWAY 0675

Maniglione BU 3328
COOL 200
Acciaio



Ral 5007/ Fuso Sabbiato BU 09759

BROADWAY 0675

Maniglione BU 3328
COOL 200
Acciaio Inox



NUOVO
MODELLO



Ral 7035

CRYSTAL 0536

Maniglione BU 104212
LUNA Nero



Ral 9018

OXFORD 0530

Maniglione BU 3639
SNOW 300
Starox



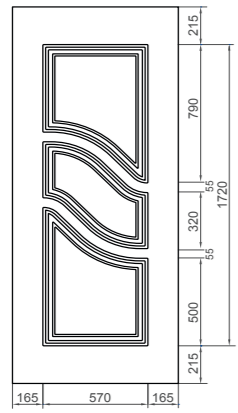

SOHO 0450SX

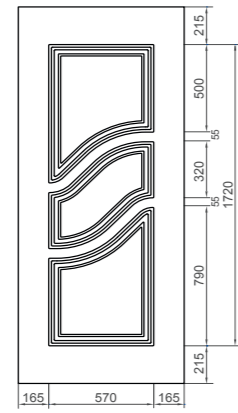

SOHO 0451DX

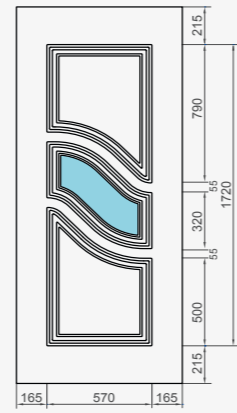

SOHO 0455SX

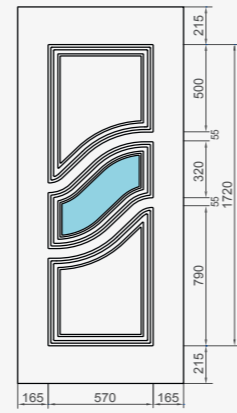

SOHO 0456DX

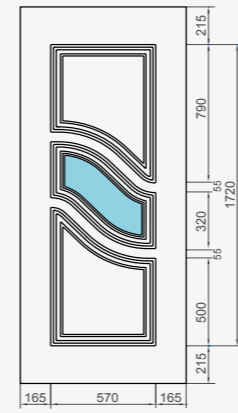

SOHO 0455SX

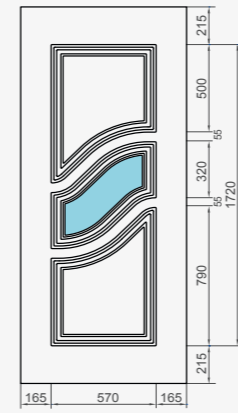

SOHO 0456DX

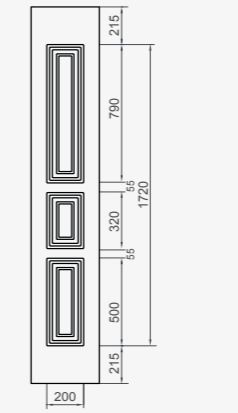

SOHO 0470

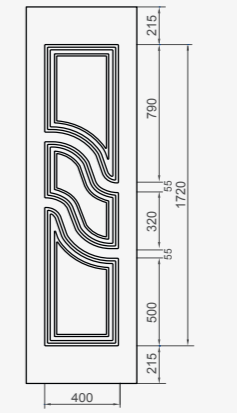

SOHO 0460SX

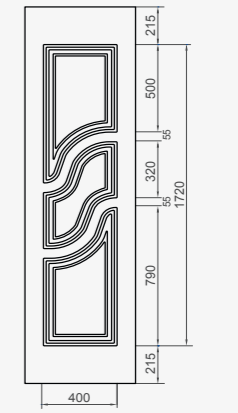

SOHO 0461DX



SOHO 0450 / 0451

Ral 9003

Maniglione BU 2304
NICE
Cromo Satinato



Ral 1013 / Tiffany BU 97704

SOHO 0455 / 0456

Maniglione BU 1044
LUNA
Cromo Satinato



Ral 1015 / Tiffany 09710

SOHO 0455 / 0456 / 0470

Maniglione BU 3648
TRENDY
Acciaio Inox AISI 316L



Ral 1014

SOHO 0460 / 0461

Maniglione BU 2054
FLESSO
Cromo Satinato



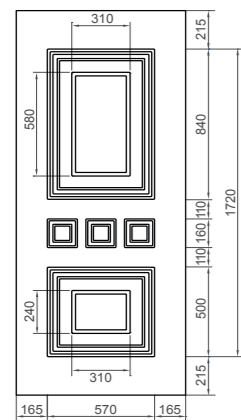

HARLEM 0560

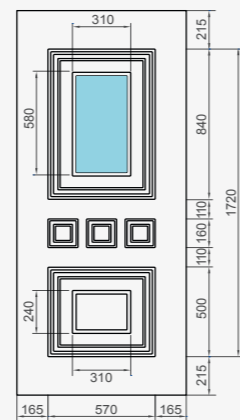

HARLEM 0565

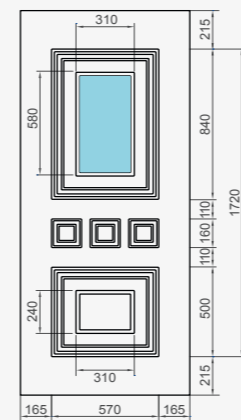

HARLEM 0565

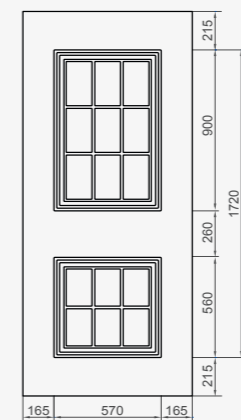

TAMIGI 0550

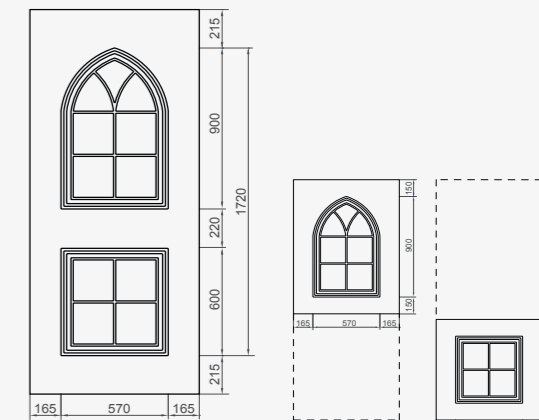

RIALTO 0700

RIALTO 0710

RIALTO 0720



Ral 7037

HARLEM 0560

Maniglione BU 352
CESARE
T.O.R.



Ral 7001 / Tiffany BU9883

HARLEM 0565

Maniglione BU 312
PLUTARCO
T.O.R.



Ral 9018 / Tiffany BU9720

HARLEM 0565

Maniglione BU 312
PLUTARCO
T.O.R.



Ral 9003

TAMIGI 0550

Maniglione BU 3639
SNOW 400
Starox



Ral 9016

RIALTO 0700

Maniglione BU 362
AUGUSTO
T.O.R.



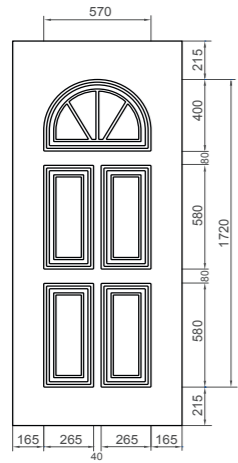

MONTPARNASSE 0750

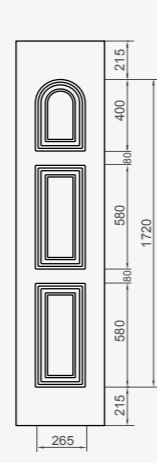

MONTPARNASSE 0760

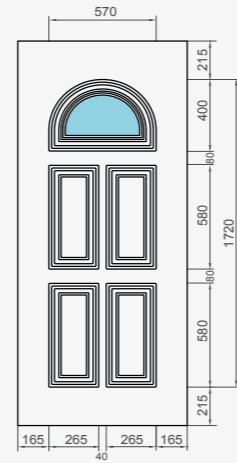

MONTPARNASSE 0755

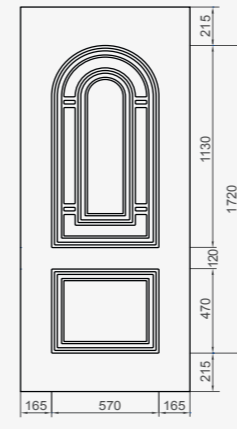

PICCADILLY 0850

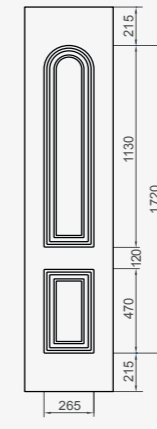

PICCADILLY 0880

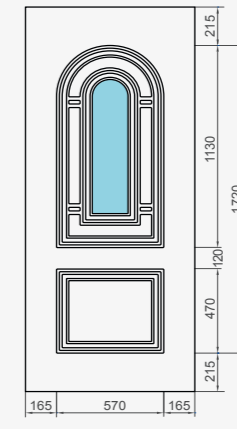

PICCADILLY 0855



Ral 1013

MONTPARNASSE 0750



Noce 43 / Tiffany BU9616

MONTPARNASSE 0760 / 0755



Platano 35

PICCADILLY 0850



Wengè / Tiffany BU9890

PICCADILLY 0855 / 0880

Maniglione BU 492
PLATONE
T.O.R.



Maniglione BU 392
PLATONE
T.O.R.



Maniglione BU 356
CESARE
Ottone Antico



Battente BU 306
ANELLO
Ottone Antico

Maniglione BU 104211
LUNA
Nero Lucido





101A

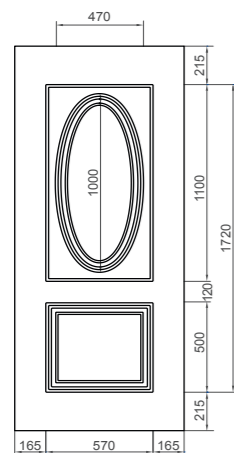

RIVOLI 0730

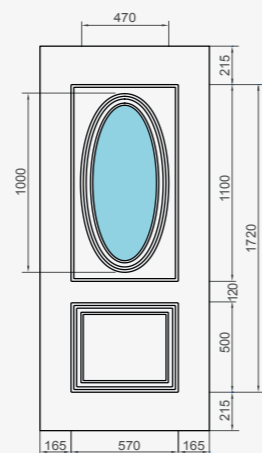

RIVOLI 0735

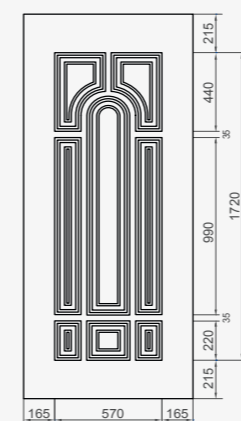

DARWEN 0141

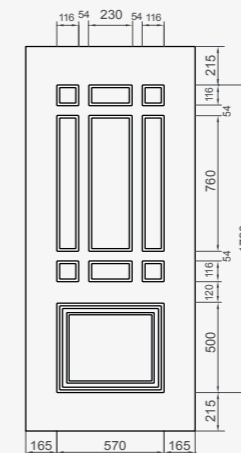

WATERLOO 0520

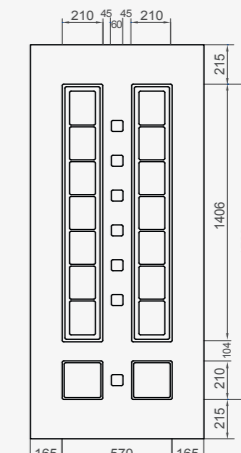

COVENT GARDEN 0480



Ral 3005

RIVOLI 0730

Battente BU 30211
Bianco Lucido

Maniglione BU 35211
CESARE
Bianco Lucido



Ral 3011 / Tiffany 09761

RIVOLI 0735

Maniglione BU 337
ARCHIMEDE
Patinet Steel



Ral 3014

DARWEN 0141

Maniglione BU 327
EUCLIDE
Patinet Steel



Battente BU 727
VIOLONCELLO
Patinet Steel



Ral 3015

WATERLOO 0520

Maniglione BU 3738
LUXURY
Acciaio Inox AISI 316L



Ral 9003

COVENT GARDEN 0480

Maniglione BU 3388
COOL 800
Acciaio



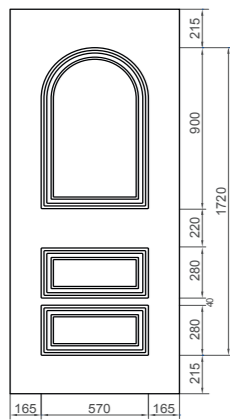

CARNABY 0950

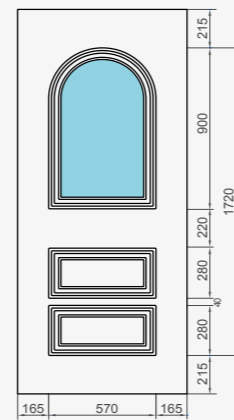

CARNABY 0955

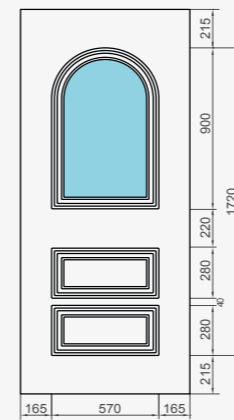

CARNABY 0955

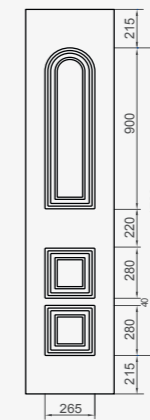

CARNABY 0980

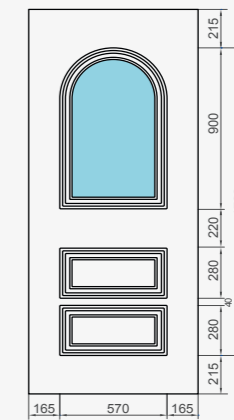

CARNABY 0955



Ral 7038

CARNABY 0950

Battente BU 682
FLAUTO
T.O.R.

Maniglione BU 402
SENECA
T.O.R.



Ral 7035 / Tiffany BU 09110

CARNABY 0955

Maniglione BU 432
ARCHIMEDE
T.O.R.



Ral 9002 / Vetro Fusione BU 00922

CARNABY 0955

Maniglione BU 432
ARCHIMEDE
T.O.R.



Ral 9003 / Tiffany BU 09889

CARNABY 0980 / 0955

Maniglione BU 3542
WARM 400
T.O.R.



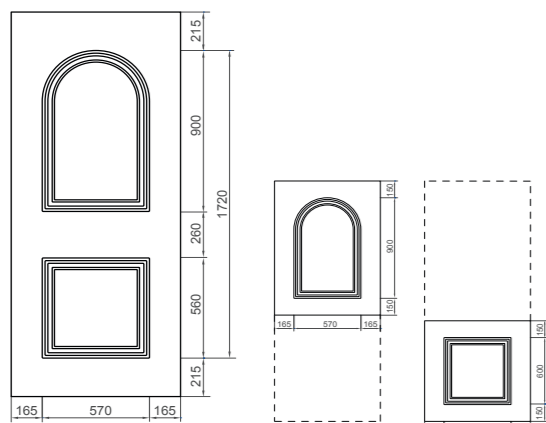

CARNABY 0900

CARNABY 0910

CARNABY 0920

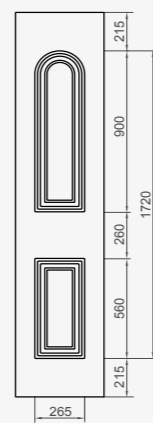

CARNABY 0988

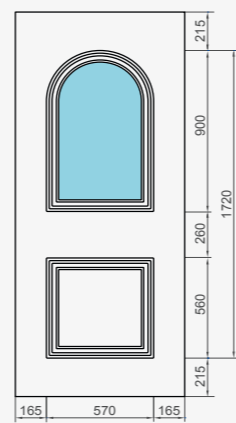

CARNABY 0905

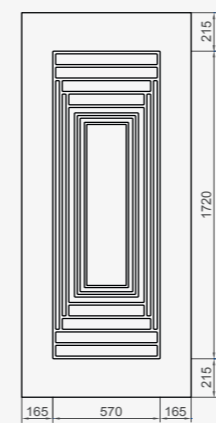

CASCAIS 0580

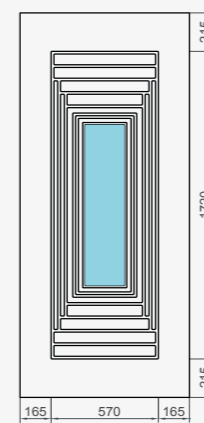

CASCAIS 0585

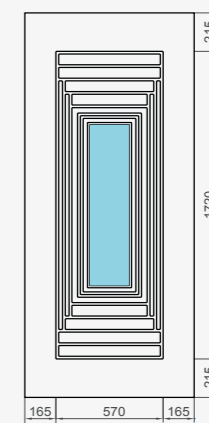

CASCAIS 0585



Ral 8004

CARNABY 0900

Battente BU 252
LEONE
T.O.R.

Battente BU 362
AUGUSTO
T.O.R.



Ral 8023 / Satinato Bianco BU 90513

CARNABY 0988 / 0905

Maniglione BU 322
EUCLIDE
T.O.R.



Ral 1013

CASCAIS 0580

Maniglione BU 3468
RAIN 600
Acciaio Inox



Ral 1011 / Fuso Sabbiato BU 09739

CASCAIS 0585

Maniglione BU 3438
RAIN 320
Acciaio Inox



Ral 1013 / Vetro Fusione BU 09734

CASCAIS 0585

Maniglione BU 3598DX
TWINS
Acciaio Inox AISI 316L

Rosette BU 2498
Acciaio Inox AISI 316L



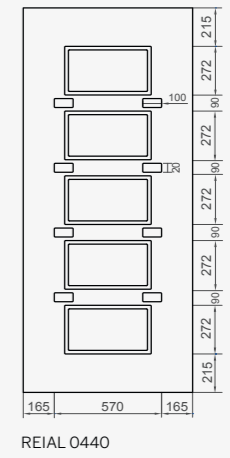
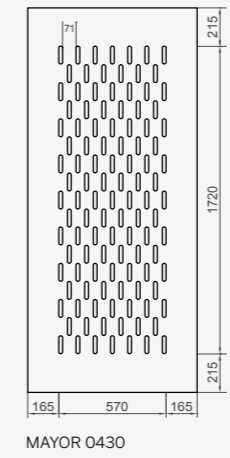
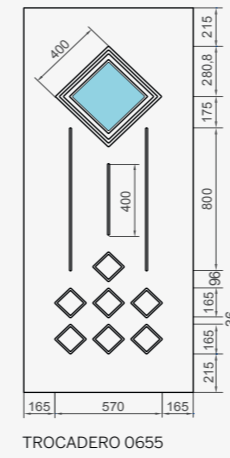
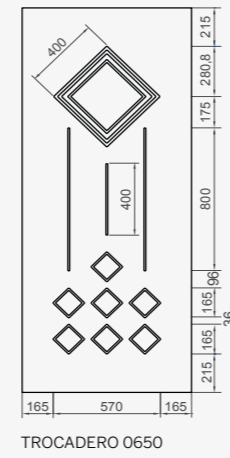
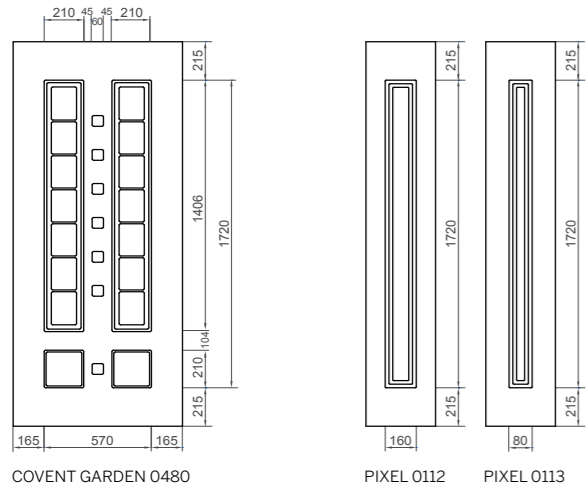

COVENT GARDEN 0480 con PIXEL 0112 / 0113

Maniglione BU 3608
FASHION
Acciaio Inox AISI 316L



TROCADERO 0650

Maniglione BU 3598SX
TWINS
Acciaio Inox AISI 316L



Rosette BU 2498
Acciaio Inox AISI 316L

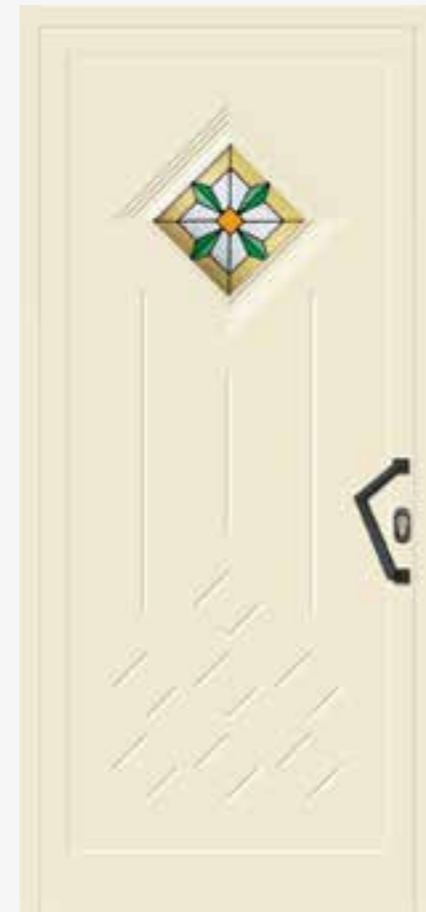

TROCADERO 0655

Maniglione BU 3595SX
TWINS
Neromat



Rosette BU 2495
Neromat



MAYOR 0430

Maniglione BU 3529
WARM 250
Starox



REIAL 0440

Maniglione BU 3629
SNOW 200
Starox



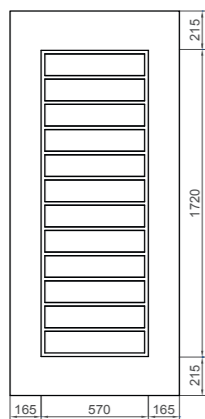

BASTIGLIA 0490



LEINCESTER 0510

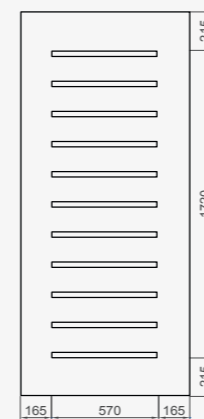

HOUSTON 0511

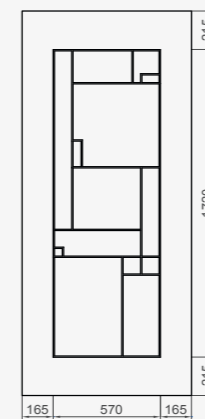

RUSSEL 0540

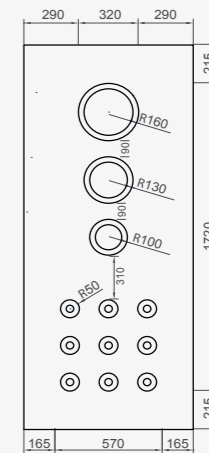

CONCORDE 0570



Ral 6005

BASTIGLIA 0490

Maniglione BU 3388
COOL 800
Acciaio



Ral 1014

LEINCESTER 0510

Maniglione BU 3608
FASHION
Acciaio Inox AISI 316L



Ral 1015

HOUSTON 0511

Maniglione BU 3438
RAIN 320
Acciaio Inox



Ral 1013

RUSSEL 0540

Maniglione BU 3588
PUNTATORE
Acciaio Inox



Ral 9003

CONCORDE 0570

Maniglione BU 3578
BIRICHINO
Acciaio Inox AISI 316L



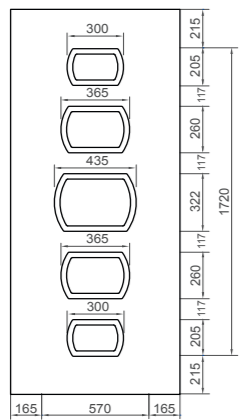

VOSGES 0590

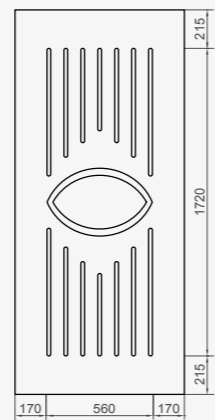

MODEM 1050

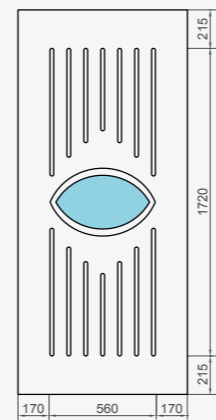

MODEM 1055

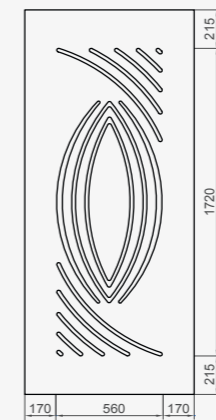

DISPLAY 1030

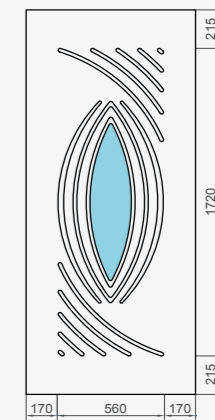

DISPLAY 1035



Ral 5004

VOSGES 0590



Ral 7001

MODEM 1050



Ral 7038 / Vetro Fusione (neutro) BU 90421

MODEM 1055



Ral 9018

DISPLAY 1030



Ral 9003 / Tiffany BU 09895

DISPLAY 1035

Maniglione BU 3468
RAIN 600
Acciaio Inox



Maniglione BU 4815
DEFAULT
Neromat



Battente BU 4825
CONNECT
Neromat



Maniglione BU 4814
DEFAULT
Cromo Satinato



Battente BU 4824
CONNECT
Cromo Satinato



Maniglione BU 4614
MEDIA
Cromo Satinato



Battente BU 4524
ROUTER
Cromo Satinato



Maniglione BU 4615
MEDIA
Neromat



Battente BU 4525
ROUTER
Neromat



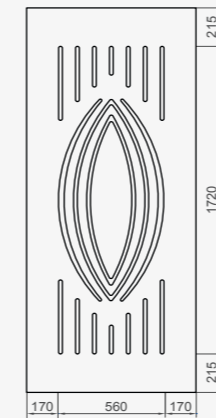

INPUT 1040

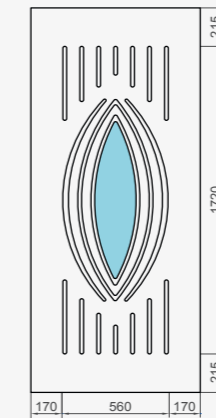

INPUT 1045

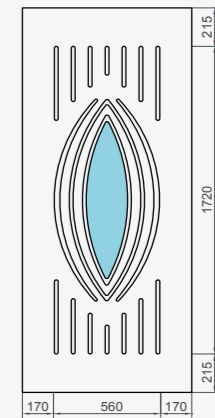

INPUT 1045



Ral 6025

INPUT 1040



Ral 6021 / Vetro Fusione (neutro) BU 90311

INPUT 1045



Ral 1014 / Vetro Fusione (rosso) BU 90344

INPUT 1045

Maniglione BU 4615
MEDIA
Neromat



Battente BU 4655
BROWSER
Neromat



Maniglione BU 4614
MEDIA
Cromo Satinato



Battente BU 4624DX
BROWSER
Cromo Satinato



Maniglione BU 4614
MEDIA
Cromo Satinato



Battente BU 4624DX
BROWSER
Cromo Satinato



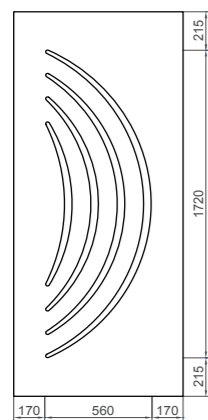

PRECOX 1010SX

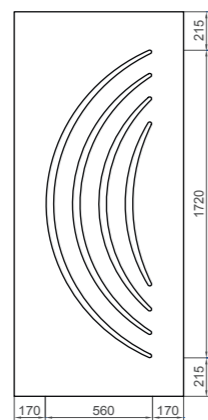

PRECOX 1011DX

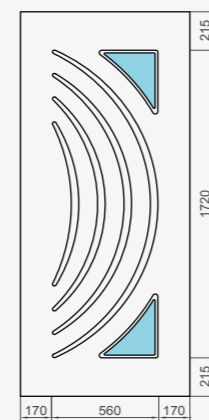

PRECOX 1015SX

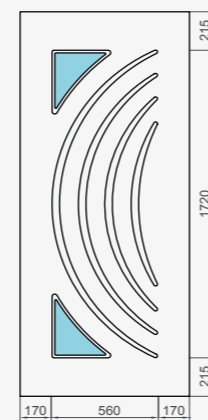

PRECOX 1016DX

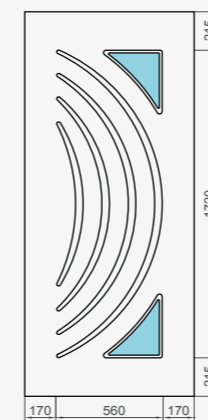

PRECOX 1015SX

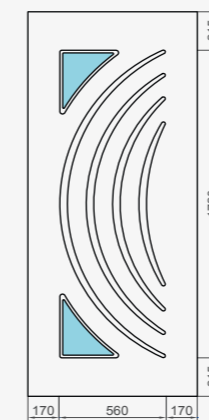

PRECOX 1016DX

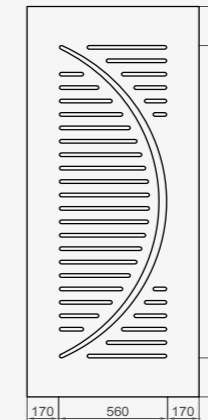

NET WORK 1020SX

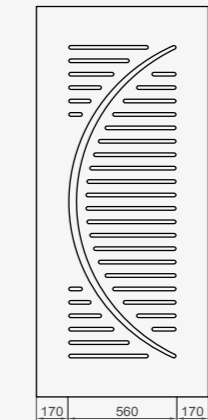

NET WORK 1021DX

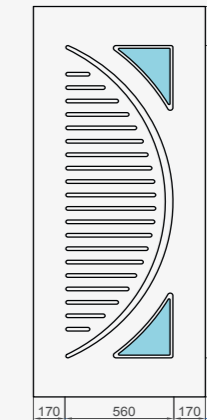

NET WORK 1025SX

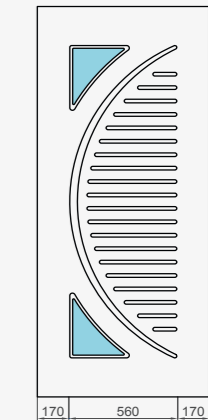

NET WORK 1026DX



Ral 5001

PRECOX 1010 / 1011

Maniglione BU 461411
MEDIA
Bianco Lucido



Ral 5015 / Tiffany BU 09910

PRECOX 1015 / 1016

Maniglione BU 4615
MEDIA
Neromat



Ral 5007 / Vetro Fusione (giallo) BU 90142

PRECOX 1015 / 1016

Maniglione BU 4615
MEDIA
Neromat



Ral 7035

NET WORK 1020 / 1021

Maniglione BU 461412
MEDIA
Nero Lucido



Ral 9018 / Vetro Fusione (neutro) BU 90121

NET WORK 1025 / 1026

Maniglione BU 4614
MEDIA
Cromo Satinato



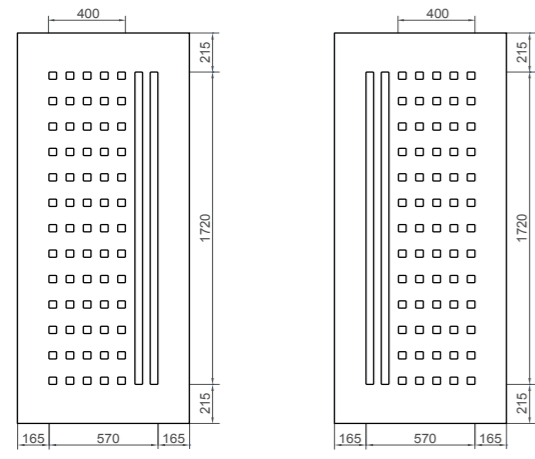

BIOS 1080SX

BIOS 1081DX

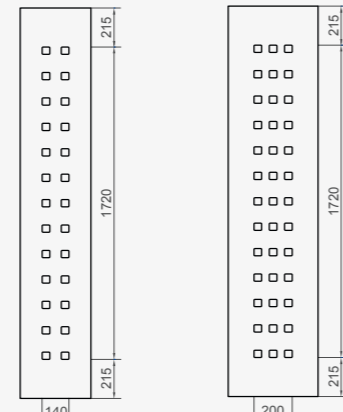

RAM 1083

RAM 1084

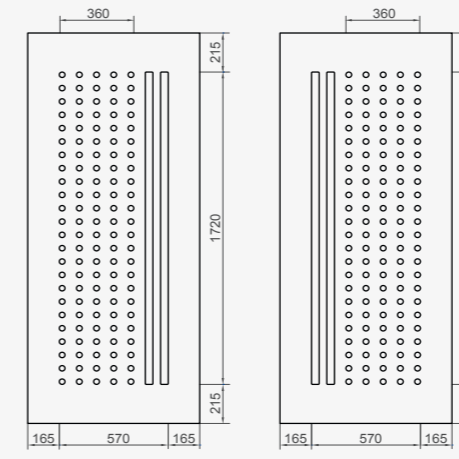

BIT 1070SX

BIT 1071DX

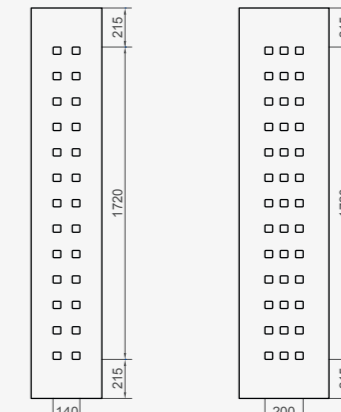

RAM 1083

RAM 1084



BIOS 1080 /1081

Ral 9003

Maniglione BU 3545
WARM 400
Neromat

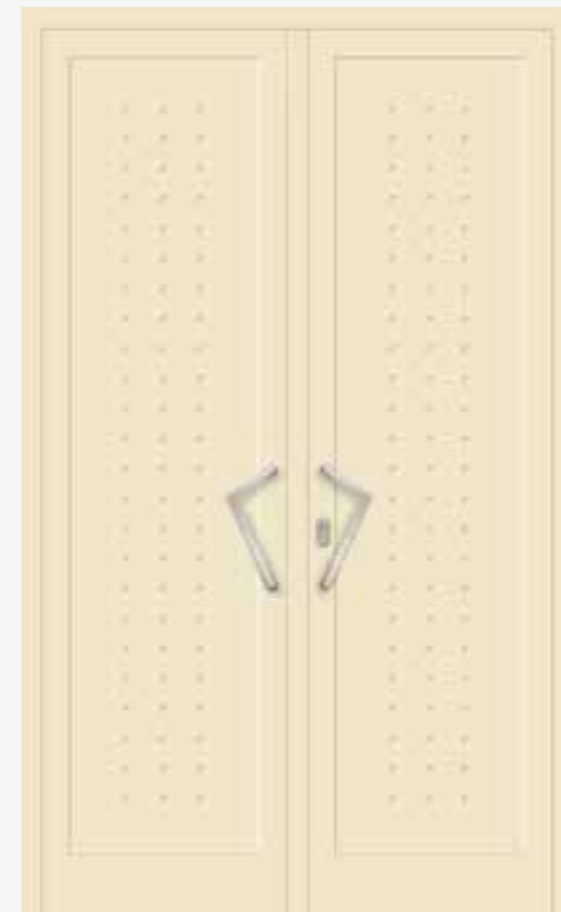

POINT 1073 / 1074

Ral 1013

Maniglione BU 3598DX-SX
TWINS
Acciaio Inox AISI 316L



BIT 1070 / 1071

Ral 1015

Maniglione BU 4514
JACK
Cromo Satinato



Battente BU 4524
ROUTER
Cromo Satinato

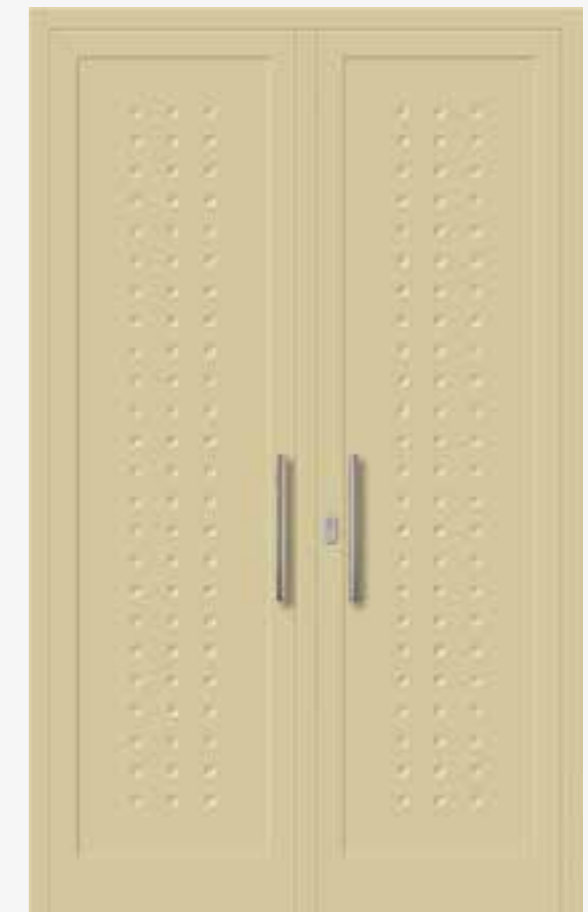

RAM 1083 / 1084

Ral 1014

Maniglione BU 3678
MAGNETIC
Acciaio Inox AISI 316L



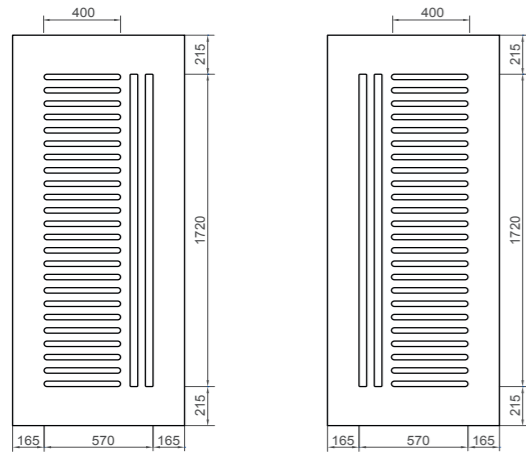

WEB 1060SX

WEB 1061DX

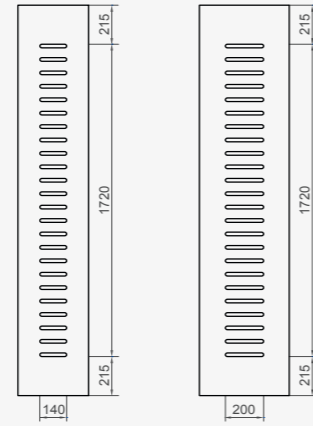

MOUSE 1063

MOUSE 1064

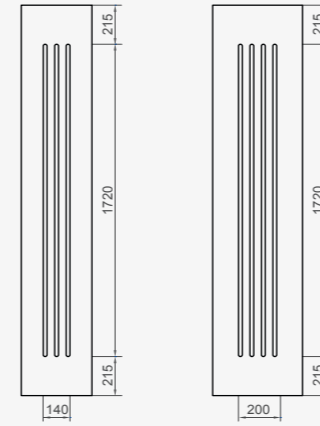

CORDLESS 1043

CORDLESS 1044

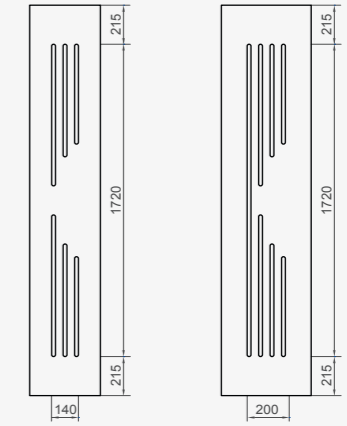

FLOPPY 1013

FLOPPY 1014



Ral 7037

WEB 1060 / 1061

Maniglione BU 4515
JACK
Neromat

Battente BU 4525
ROUTER
Neromat



Ral 7001

MOUSE 1063 / 1064

Maniglione BU 3328
COOL 200
Acciaio



Ral 9018

CORDLESS 1043 / 1044

Maniglione BU 3348
COOL 400
Acciaio inox



Ral 9016

FLOPPY 1013 / 1014

Maniglione BU 3608
FASHION
Acciaio inox





UENO 1101



pag. 24

BABILA 1102



pag. 24

CLOTILDE 1103



pag. 24

GINZA 1104



pag. 25

BROOKLIN 1105



pag. 25

GREENWICH 1106



pag. 25

CARDUSIO 1107



pag. 26

NAVONA 1108



pag. 26

LUSTGARTEN 1109



pag. 26

SHIBUYA 1110



pag. 27

MINERVA 1111



pag. 27

DARLING 1112



pag. 27

MITTE 1113



pag. 28

SAMARCANDA 1114



pag. 28

MONACO 1120



pag. 30

MONACO 1125



pag. 30

ISTANBUL 1130



pag. 30

ISTANBUL 1135



pag. 31

TORONTO 1140



pag. 31

TORONTO 1145



pag. 31

ARSENAL 0100



pag. 34

GREENFORD 0110 / ARSENAL 0100



pag. 34

GREENFORD 115 / ARSENAL 105



pag. 35

ARSENAL 105



pag. 35

ASTON 0301



pag. 36

ASTON 0315 / 0305



pag. 36

BOLTON 0302



pag. 37

BOLTON 0303 / 0302



pag. 37

WEST 0322



pag. 38

WEST 0321 / 0322



pag. 38

KENTON 0120 / 0121



pag. 39

KENTON 0125 / 0126



pag. 39

KENTON 0130 / 0131



pag. 39

KENNINGTON 0160



pag. 42

KENNINGTON 0165



pag. 42

KENNINGTON 0165



pag. 43

WEMBLEY 0140



pag. 43

WEMBLEY 0145



pag. 43

VICTORIA 0180



pag. 44

VICTORIA 0185



pag. 45

VICTORIA 0185



pag. 45

CARDIFF 0790



pag. 45

FARNESE 0161



pag. 45

REGENT 0770



pag. 46

REGENT 0775



pag. 46

REGENT 0775



pag. 47

MADISON 0780



pag. 47

MADISON 0785



pag. 49

QUEENS 0630



pag. 49

QUEENS 0635



pag. 49

BRERA 0500



pag. 49

ORLANDO 0401



pag. 50

ORLANDO 0405



pag. 50

TRAFALGAR 0600



pag. 51

TRAFALGAR 0605



pag. 51

TRAFALGAR 0615



pag. 51

MANHATTAN 0800



pag. 52

PIGALLE 0810



pag. 52

RIO 0300



pag. 53

RIO 0300 / 0350



pag. 53

RIO 0330



pag. 54

RIO 0330 / 0380

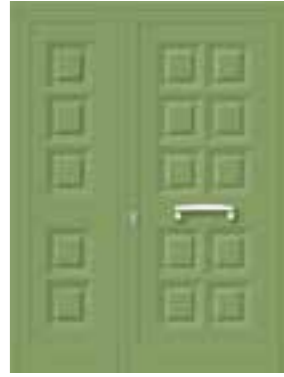

pag. 54

PARIOLI 0200



pag. 55

PARIOLI 0230 / 0250



pag. 55

PARIOLI 0230



pag. 55

RAMBLAS 0400



pag. 58

RAMBLAS 0410



pag. 58

RAMBLAS 0400 / 0420



pag. 59

BARBERINI 0533



pag. 59

BELLINI 0532



pag. 59

BROADWAY 0670



pag. 60

BROADWAY 0675



pag. 60

BROADWAY 0675



pag. 61

CRYSTAL 0536



pag. 61

OXFORD 0530



pag. 61

SOHO 0450 / 0451



pag. 62

SOHO 0455 / 0456



pag. 62

SOHO 0455 / 0456 / 0470



pag. 63

SOHO 0460 / 0461



pag. 63

HARLEM 0560



pag. 64

HARLEM 0565



pag. 64

HARLEM 0565



pag. 65

TAMIGI 0550



pag. 65

RIALTO 0700



pag. 65

MONTPARNASSE 0750



pag. 66

MONTPARNASSE 0760 / 0755



pag. 66

PICCADILLY 0850



pag. 67

PICCADILLY 0855 / 0880



pag. 67

RIVOLI 0730



pag. 70

RIVOLI 0735



pag. 70

DARWEN 0141



pag. 71

WATERLOO 0520



pag. 71

COVENT GARDEN 0480



pag. 71

CARNABY 0950



pag. 72

CARNABY 0955



pag. 72

CARNABY 0955



pag. 73

CARNABY 0980 / 0955



pag. 73

CARNABY 0900



pag. 74

CARNABY 0988 / 0905



pag. 74

CASCAIS 0580



pag. 75

CASCAIS 0585



pag. 75

CASCAIS 0585



pag. 75

COVENT 0480 con PIXEL 0112 / 0113



pag. 76

TROCADERO 0650



pag. 76

TROCADERO 0655



pag. 77

MAYOR 0430



pag. 77

REIAL 0440



pag. 77

BASTIGLIA 0490



pag. 78

LEINCESTER 0510



pag. 78

HOUSTON 0511



pag. 79

RUSSEL 0540



pag. 79

CONCORDE 0570



pag. 79

VOSGES 0590



pag. 80

MODEM 1050



pag. 80

MODEM 1055



pag. 81

DISPLAY 1030



pag. 81

DISPLAY 1035



pag. 81

INPUT 1040



pag. 83

INPUT 1045



pag. 83

INPUT 1045



pag. 83

PRECOX 1010 / 1011



pag. 84

PRECOX 1015 / 1016



pag. 84

PRECOX 1015 / 1016



pag. 85

NETWORK 1020 / 1021



pag. 85

NETWORK 1025 / 1026



pag. 85

BIOS 1080 / 1081



pag. 86

POINT 1073 / 1074

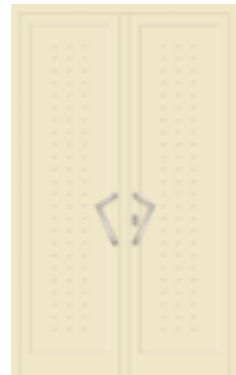

pag. 86

BIT 1070 / 1071



pag. 87

RAM 1083 / 1084



pag. 87

WEB 1060 / 1061



pag. 88

MOUSE 1063 / 1064



pag. 88

CORDLESS 1043 / 1044



pag. 89

FLOPPY 1013 / 1014



pag. 89

COLORI E FINITURE

COLORI STANDARD

RAL 1013 - RAL 6005 - RAL 8017 - RAL 9001 - RAL 9010.

Rif. cartella colori Ponzio.

PREZZO COLORI BASE

COLORI FUORI STANDARD

Tutti i colori verniciati o RAL.

Rif. cartella colori Ponzio.

PREZZO VERN. PARTICOLARE

COLORI CAMPIONE

Si richiede l'invio di 2 Kg di polvere in **c/to omaggio** per ogni pannello, insieme ad un lamierino in alluminio come riferimento colore.

In assenza del campione colore non garantiamo eventuali differenze.

PREZZO VERN. PARTICOLARE

VERNICIATO LEGNO

Tutti i colori rif. cartella Uberall Ponzio.

Grazie alla preziosa collaborazione con aziende leader del settore, siamo in grado di fornire un'ampia gamma di colori legno in pronta consegna o a richiesta (contattare i ns. uffici per ricevere la lista delle tinte legno disponibili).

PREZZO VERN. LEGNO

RENOLIT

Rivestimento con pellicola Renolit: Rovere Gold (ciliegio) 2178001 - Mogano 2097013 - Noce 3149008 - Noce scuro 2178005 - Avorio 137905 - Blu 515005 - Verde 612505 - Bianco 915205 - Castagno noce 2178007 - Black Cherry 3202001 - Rosso 308105 - Rovere scuro 2052089 - Mogano 2065021. Altri colori su richiesta.

PREZZO BICOL-RENOLIT - OX

ANODIZZATI

Argento - bronzo - bronzo scuro - elettrocolore chiaro - elettrocolore - nero.

Rif. cartella colori Ponzio.

PREZZO BICOL-RENOLIT - OX

BICOLOREVERNICIATI-RENOLIT-ANODIZZATI

Un lato colore standard/ fuori standard / colori a campione / Renolit / anodizzato; lato opposto colore standard / fuori standard / colori a campione / Renolit / anodizzato.

PREZZO BICOL-RENOLIT - OX

VERNICIATO LEGNO

Un lato colore standard/ fuori standard / colori a campione / Renolit / anodizzato / verniciato legno; lato opposto colore standard / fuori standard / colori a campione / Renolit / anodizzato / verniciato legno.

PREZZO VERN. LEGNO

LISTINO PREZZI NUOVI PANNELLI

Dimensioni standard cm. 90x215 *(per spessore mm. 7 e 15 dim. standard cm. 95x215)

M.D.F.

*7 mm	Codice	BM 07 + cod. modello
	Verniciato	€ 754,00
	Vern. legno	€ 1.144,00
*15 mm	Codice	BM 15 + cod. modello
	Verniciato	€ 923,00
	Vern. legno	€ 1.235,00
22 mm	Codice	BM 22 + cod. modello
	Col. base	€ 1.053,00
	Vern. particolare	€ 1.131,00
	Bicol-Renolit - Ox	€ 1.235,00
31 mm	Codice	BM 31 + cod. modello
	Col. base	€ 1.235,00
	Vern. particolare	€ 1.313,00
	Bicol-Renolit - Ox	€ 1.417,00
42 mm	Codice	BM 42 + cod. modello
	Col. base	€ 1.739,00
	Vern. particolare	€ 1.942,00
	Bicol-Renolit - Ox	€ 2.015,00
	Vern. legno	€ 2.706,00

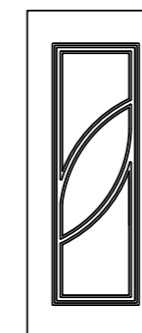

UENO 1101

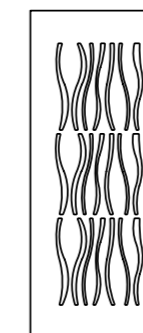

BABILA 1102

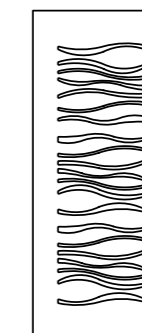

CLOTILDE 1103

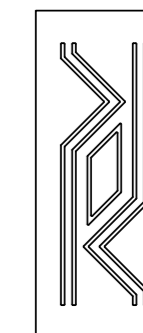

GINZA 1104



BROOKLYN 1105

P.I.R.

25 mm	Codice	BP 25 + cod. modello
	Col. base	€ 1.235,00
	Vern. particolare	€ 1.313,00
	Bicol-Renolit - Ox	€ 1.417,00
30 mm	Codice	BP 30 + cod. modello
	Col. base	€ 1.365,00
	Vern. particolare	€ 1.443,00
	Bicol-Renolit - Ox	€ 1.547,00
	Vern. legno	€ 2.015,00

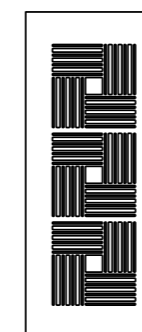

GREENWICH 1106

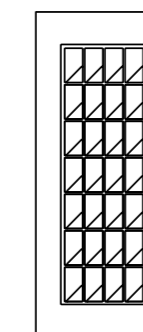

CARDUSIO 1107

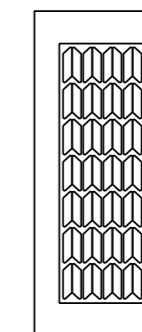

NAVONA 1108

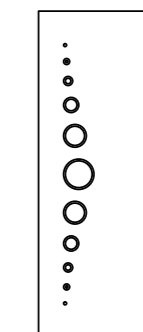

LUSTGARTEN 1109

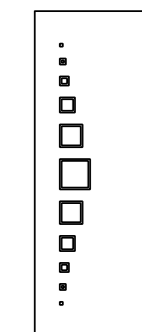

SHIBUYA 1110

H.I.

ANIMA FLESSIBILE

26 mm	Codice	BA 26 + cod. modello
	Col. base	€ 1.417,00
	Vern. particolare	€ 1.495,00
	Bicol-Renolit - Ox	€ 1.599,00
30 mm	Codice	BA 30 + cod. modello
	Col. base	€ 1.469,00
	Vern. particolare	€ 1.547,00
	Bicol-Renolit - Ox	€ 1.651,00
35 mm	Codice	BA 35 + cod. modello
	Col. base	€ 1.560,00
	Vern. particolare	€ 1.638,00
	Bicol-Renolit - Ox	€ 1.742,00
40 mm	Codice	BA 40 + cod. modello
	Col. base	€ 1.677,00
	Vern. particolare	€ 1.755,00
	Bicol-Renolit - Ox	€ 1.859,00
	Vern. legno	€ 2.327,00

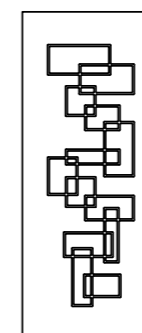

MINERVA 1111

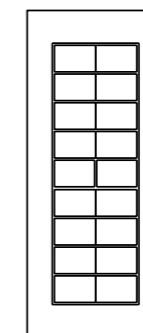

DARLING 1112

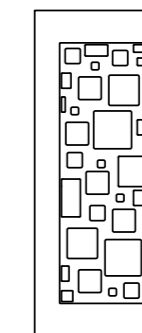

MITTE 1113

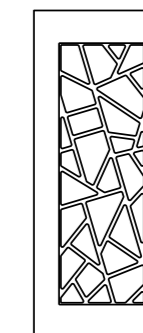

SAMARCANDA 1114

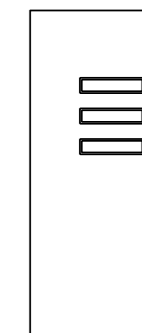

MONACO 1120

P.O.L.

*7 mm	Codice	BB 07 + cod. modello
	Verniciato	€ 936,00
	Vern. legno	€ 1.365,00
*15 mm	Codice	BB 15 + cod. modello
	Verniciato	€ 1.144,00
	Vern. legno	€ 1.534,00
22 mm	Codice	BB 22 + cod. modello
	Col. base	€ 1.235,00
	Vern. particolare	€ 1.313,00
	Bicol-Renolit - Ox	€ 1.417,00
31 mm	Codice	BB 31 + cod. modello
	Col. base	€ 1.391,00
	Vern. particolare	€ 1.469,00
	Bicol-Renolit - Ox	€ 1.573,00
	Vern. legno	€ 2.041,00

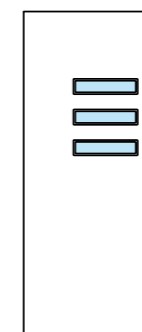

MONACO 1125

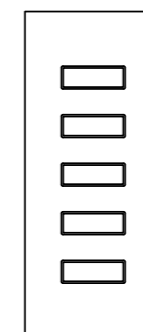

ISTANBUL 1130

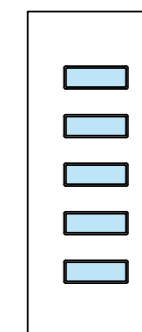

ISTANBUL 1135

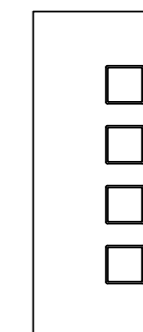

TORONTO 1140

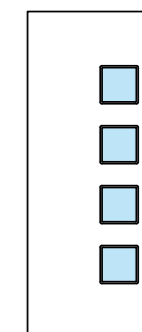

TORONTO 1145

(gli art. 1125, 1135, 1145, non sono realizzabili in: MDF spessore mm. 7-22-42; PIR spessore mm. 25; POL spessore mm. 7-22)

M.D.F.

*7 mm	Codice	BM 07 + cod. modello
	Verniciato	€ 580,00
	Vern. legno	€ 880,00
*15 mm	Codice	BM 15 + cod. modello
	Verniciato	€ 710,00
	Vern. legno	€ 950,00
22 mm	Codice	BM 22 + cod. modello
	Col. base	€ 810,00
	Vern. particolare	€ 870,00
	Bicol-Renolit - Ox	€ 950,00
	Vern. legno	€ 1.300,00
31 mm	Codice	BM 31 + cod. modello
	Col. base	€ 950,00
	Vern. particolare	€ 1.010,00
	Bicol-Renolit - Ox	€ 1.090,00
	Vern. legno	€ 1.480,00
42 mm	Codice	BM 42 + cod. modello
	Col. base	€ 1.338,00
	Vern. particolare	€ 1.494,00
	Bicol-Renolit - Ox	€ 1.550,00
	Vern. legno	€ 2.082,00

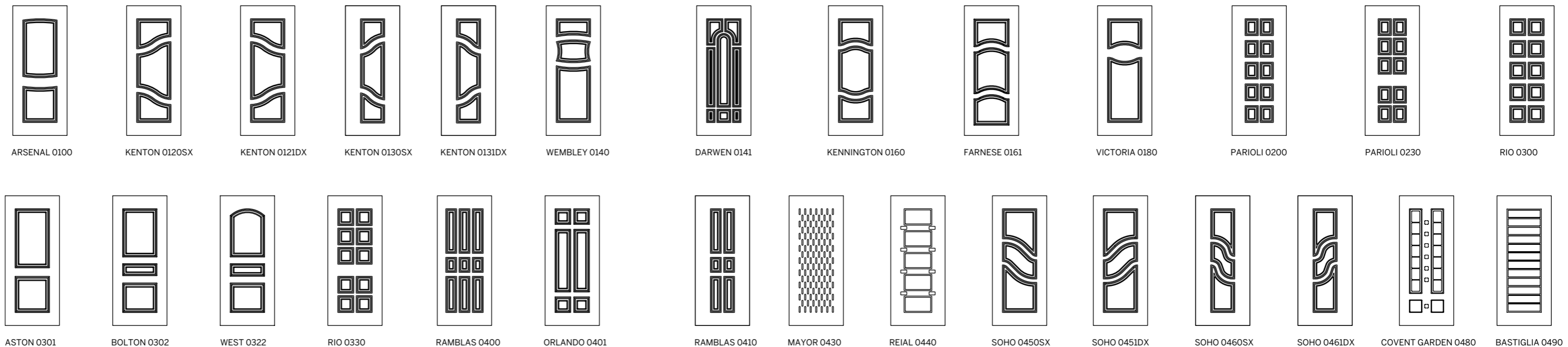

P.I.R.

25 mm	Codice	BP 25 + cod. modello
	Col. base	€ 950,00
	Vern. particolare	€ 1.010,00
	Bicol-Renolit - Ox	€ 1.090,00
	Vern. legno	€ 1.420,00
30 mm	Codice	BP 30 + cod. modello
	Col. base	€ 1.050,00
	Vern. particolare	€ 1.110,00
	Bicol-Renolit - Ox	€ 1.190,00
	Vern. legno	€ 1.550,00

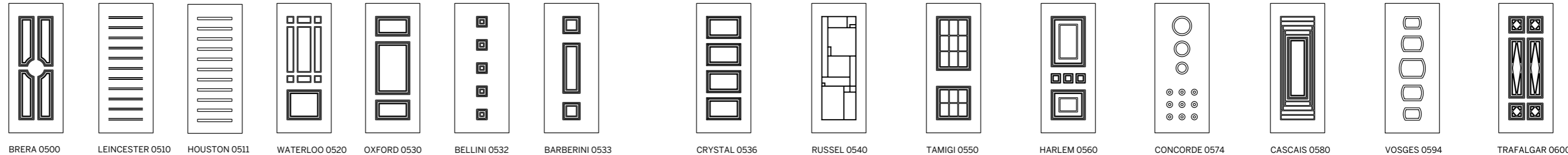

H.I. ANIMA FLESSIBILE

26 mm	Codice	BA 26 + cod. modello
	Col. base	€ 1.090,00
	Vern. particolare	€ 1.150,00
	Bicol-Renolit - Ox	€ 1.230,00
	Vern. legno	€ 1.590,00
30 mm	Codice	BA 30 + cod. modello
	Col. base	€ 1.130,00
	Vern. particolare	€ 1.190,00
	Bicol-Renolit - Ox	€ 1.270,00
	Vern. legno	€ 1.630,00
35 mm	Codice	BA 35 + cod. modello
	Col. base	€ 1.200,00
	Vern. particolare	€ 1.260,00
	Bicol-Renolit - Ox	€ 1.340,00
	Vern. legno	€ 1.700,00
40 mm	Codice	BA 40 + cod. modello
	Col. base	€ 1.290,00
	Vern. particolare	€ 1.350,00
	Bicol-Renolit - Ox	€ 1.430,00
	Vern. legno	€ 1.790,00

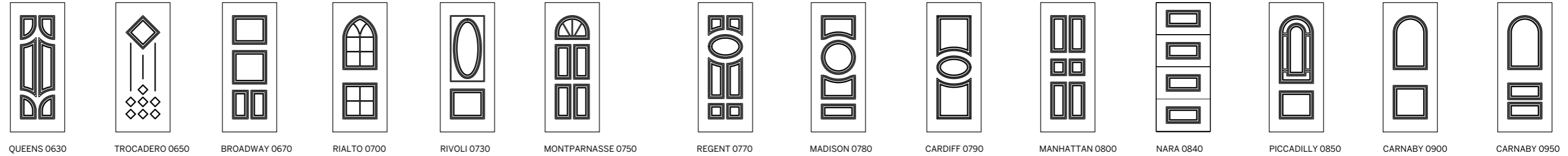

P.O.L.

*7 mm	Codice	BB 07 + cod. modello
	Verniciato	€ 720,00
	Vern. legno	€ 1.050,00
*15 mm	Codice	BB 15 + cod. modello
	Verniciato	€ 880,00
	Vern. legno	€ 1.180,00
22 mm	Codice	BB 22 + cod. modello
	Col. base	€ 950,00
	Vern. particolare	€ 1.010,00
	Bicol-Renolit - Ox	€ 1.090,00
	Vern. legno	€ 1.420,00
31 mm	Codice	BB 31 + cod. modello
	Col. base	€ 1.070,00
	Vern. particolare	€ 1.130,00
	Bicol-Renolit - Ox	€ 1.210,00
	Vern. legno	€ 1.570,00

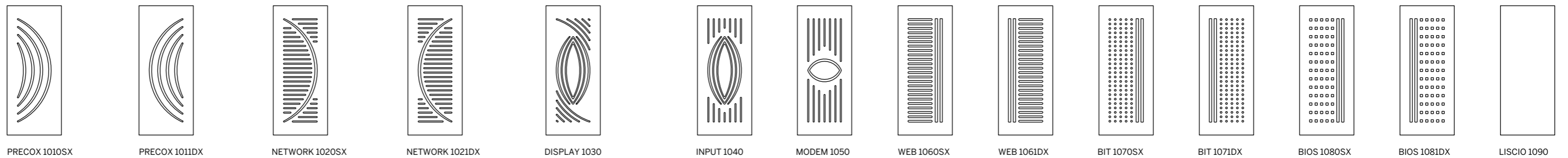

M.D.F.

* 15 mm	Codice	BM 15 + cod. modello
	Verniciato	€ 950,00
	Vern. legno	€ 1.190,00
**22 mm	Codice	BM 22 + cod. modello
	Col. base	€ 1.050,00
	Vern. particolare	€ 1.110,00
	Bicol-Renolit - Ox	€ 1.190,00
	Vern. legno	€ 1.540,00
31 mm	Codice	BM 31 + cod. modello
	Col. base	€ 1.190,00
	Vern. particolare	€ 1.250,00
	Bicol-Renolit - Ox	€ 1.330,00
	Vern. legno	€ 1.720,00

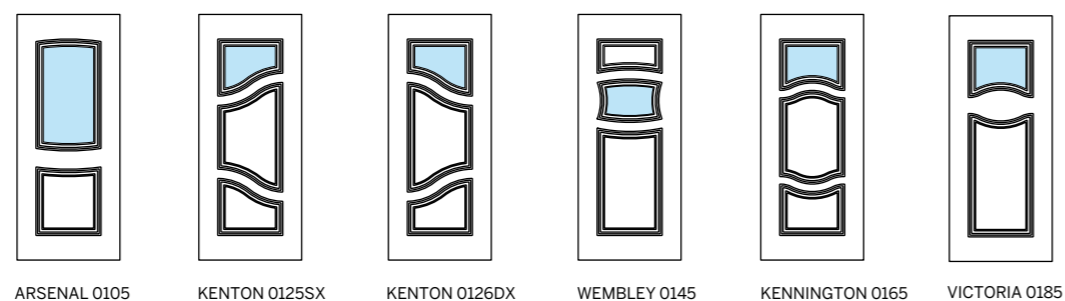

P.I.R.

30 mm	Codice	BP 30 + cod. modello
	Col. base	€ 1.290,00
	Vern. particolare	€ 1.350,00
	Bicol-Renolit - Ox	€ 1.430,00
	Vern. legno	€ 1.790,00

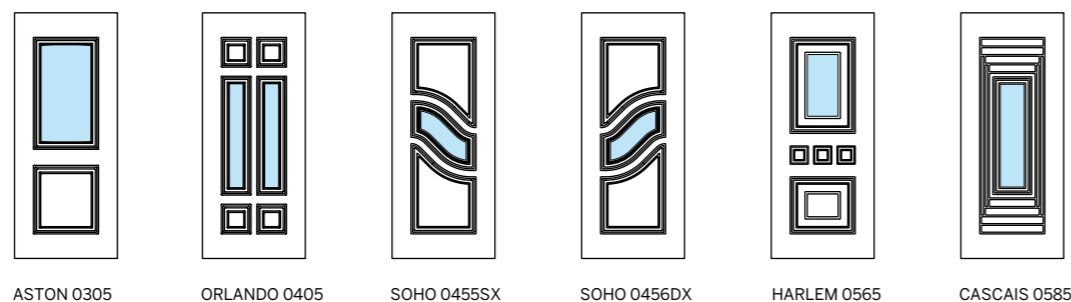

H.I. ANIMA FLESSIBILE

26 mm	Codice	BA 26 + cod. modello
	Col. base	€ 1.330,00
	Vern. particolare	€ 1.390,00
	Bicol-Renolit - Ox	€ 1.470,00
	Vern. legno	€ 1.830,00
30 mm	Codice	BA 30 + cod. modello
	Col. base	€ 1.370,00
	Vern. particolare	€ 1.430,00
	Bicol-Renolit - Ox	€ 1.510,00
	Vern. legno	€ 1.870,00
35 mm	Codice	BA 35 + cod. modello
	Col. base	€ 1.440,00
	Vern. particolare	€ 1.500,00
	Bicol-Renolit - Ox	€ 1.580,00
	Vern. legno	€ 1.940,00
40 mm	Codice	BA 40 + cod. modello
	Col. base	€ 1.530,00
	Vern. particolare	€ 1.590,00
	Bicol-Renolit - Ox	€ 1.670,00
	Vern. legno	€ 2.030,00

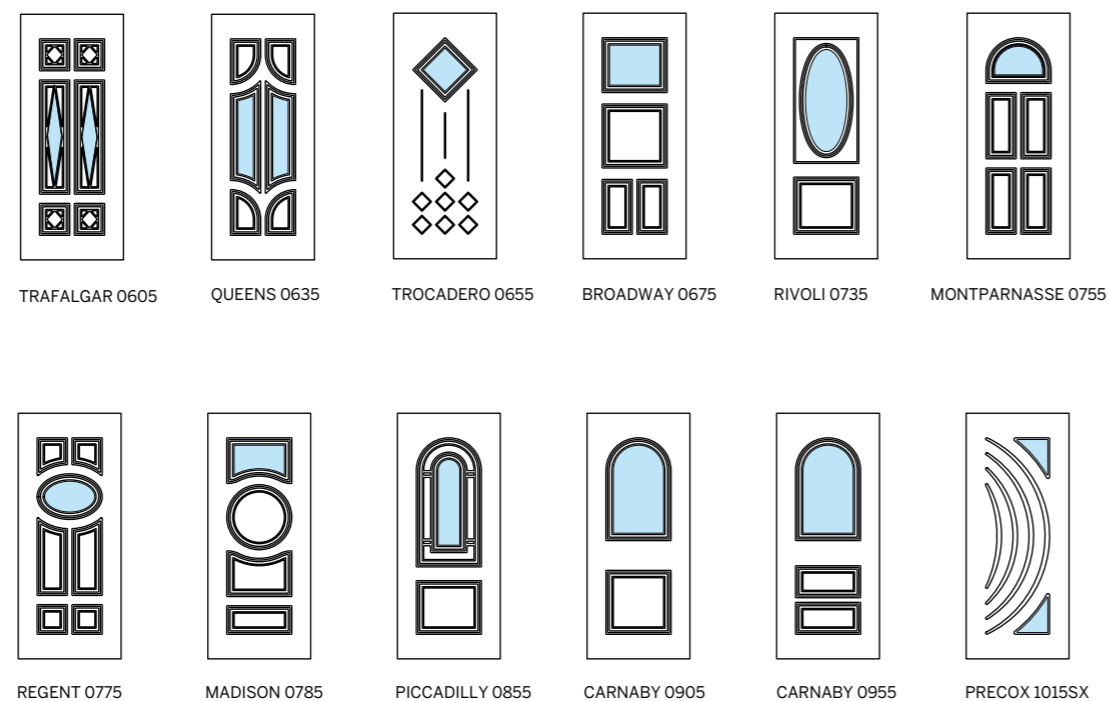

P.O.L.

* 15 mm	Codice	BB 15 + cod. modello
	Verniciato	€ 1.120,00
	Vern. legno	€ 1.420,00
**22 mm	Codice	BB 22 + cod. modello
	Col. base	€ 1.190,00
	Vern. particolare	€ 1.250,00
	Bicol-Renolit - Ox	€ 1.330,00
	Vern. legno	€ 1.660,00
31 mm	Codice	BB 31 + cod. modello
	Col. base	€ 1.310,00
	Vern. particolare	€ 1.370,00
	Bicol-Renolit - Ox	€ 1.450,00
	Vern. legno	€ 1.810,00

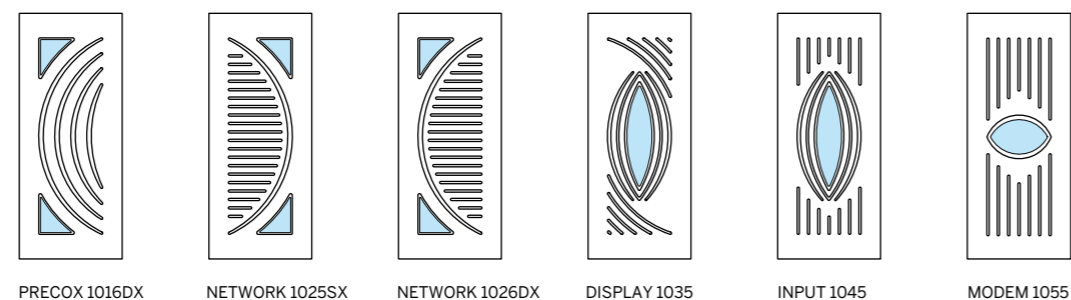

** Disponibile solo nei modelli con nuova cornice fermavetro.

M.D.F.

15 mm	Codice	BM 15 + cod. modello
	Verniciato	€ 595,00
	Vern. legno	€ 715,00
**22 mm	Codice	BM 22 + cod. modello
	Col. base	€ 645,00
	Vern. particolare	€ 675,00
	Bicol-Renolit - Ox	€ 715,00
	Vern. legno	€ 890,00
31 mm	Codice	BM 31 + cod. modello
	Col. base	€ 715,00
	Vern. particolare	€ 745,00
	Bicol-Renolit - Ox	€ 785,00
	Vern. legno	€ 980,00

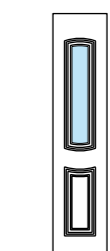

GREENFORD 0115

P.I.R.

30 mm	Codice	BP 30 + cod. modello
	Col. base	€ 765,00
	Vern. particolare	€ 795,00
	Bicol-Renolit - Ox	€ 835,00
	Vern. legno	€ 1.015,00

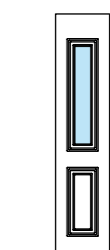

ASTON 0315

H.I. ANIMA FLESSIBILE

26 mm	Codice	BA 26 + cod. modello
	Col. base	€ 785,00
	Vern. particolare	€ 815,00
	Bicol-Renolit - Ox	€ 855,00
	Vern. legno	€ 1.035,00
30 mm	Codice	BA 30 + cod. modello
	Col. base	€ 805,00
	Vern. particolare	€ 835,00
	Bicol-Renolit - Ox	€ 875,00
	Vern. legno	€ 1.055,00
35 mm	Codice	BA 35 + cod. modello
	Col. base	€ 840,00
	Vern. particolare	€ 870,00
	Bicol-Renolit - Ox	€ 910,00
	Vern. legno	€ 1.090,00
40 mm	Codice	BA 40 + cod. modello
	Col. base	€ 885,00
	Vern. particolare	€ 915,00
	Bicol-Renolit - Ox	€ 955,00
	Vern. legno	€ 1.135,00

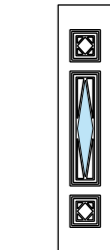

TRAFALGAR 0615

P.O.L.

15 mm	Codice	BB 15 + cod. modello
	Verniciato	€ 680,00
	Vern. legno	€ 830,00
**22 mm	Codice	BB 22 + cod. modello
	Col. base	€ 715,00
	Vern. particolare	€ 745,00
	Bicol-Renolit - Ox	€ 785,00
	Vern. legno	€ 950,00
31 mm	Codice	BB 31 + cod. modello
	Col. base	€ 715,00
	Vern. particolare	€ 805,00
	Bicol-Renolit - Ox	€ 845,00
	Vern. legno	€ 1.025,00

** Disponibile solo nei modelli con nuova cornice fermavetro.

M.D.F.

7 mm	Codice	BM 7 + cod. modello
	Verniciato	€ 290,00
	Vern. legno	€ 440,00
15 mm	Codice	BM 15 + cod. modello
	Verniciato	€ 355,00
	Vern. legno	€ 475,00
22 mm	Codice	BM 22 + cod. modello
	Col. base	€ 405,00
	Vern. particolare	€ 435,00
	Bicol-Renolit - Ox	€ 475,00
	Vern. legno	€ 650,00
31 mm	Codice	BM 31 + cod. modello
	Col. base	€ 475,00
	Vern. particolare	€ 505,00
	Bicol-Renolit - Ox	€ 545,00
	Vern. legno	€ 740,00
42 mm	Codice	BM 42 + cod. modello
	Col. base	€ 669,00
	Vern. particolare	€ 747,00
	Bicol-Renolit - Ox	€ 775,00
	Vern. legno	€ 1.041,00

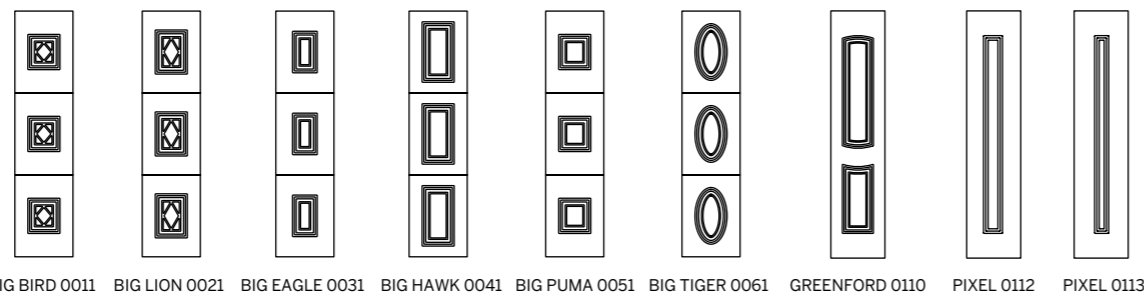

P.I.R.

25 mm	Codice	BP 25 + cod. modello
	Col. base	€ 475,00
	Vern. particolare	€ 505,00
	Bicol-Renolit - Ox	€ 545,00
	Vern. legno	€ 710,00
30 mm	Codice	BP 30 + cod. modello
	Col. base	€ 525,00
	Vern. particolare	€ 555,00
	Bicol-Renolit - Ox	€ 595,00
	Vern. legno	€ 775,00

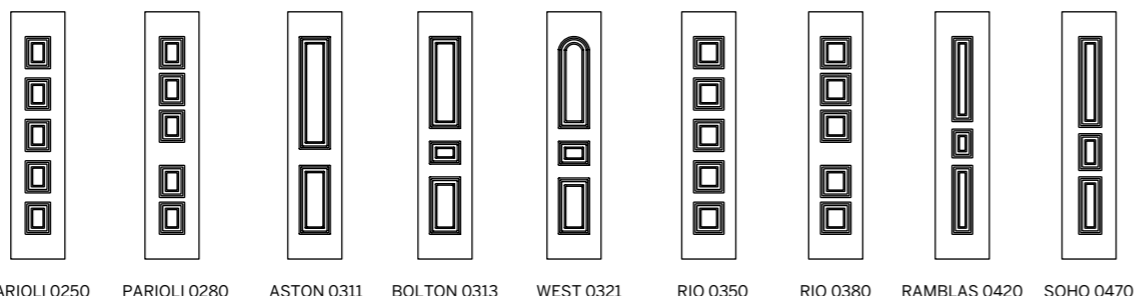

H.I. ANIMA FLESSIBILE

26 mm	Codice	BA 26 + cod. modello
	Col. base	€ 545,00
	Vern. particolare	€ 575,00
	Bicol-Renolit - Ox	€ 615,00
	Vern. legno	€ 795,00
30 mm	Codice	BA 30 + cod. modello
	Col. base	€ 565,00
	Vern. particolare	€ 595,00
	Bicol-Renolit - Ox	€ 635,00
	Vern. legno	€ 815,00
35 mm	Codice	BA 35 + cod. modello
	Col. base	€ 600,00
	Vern. particolare	€ 630,00
	Bicol-Renolit - Ox	€ 670,00
	Vern. legno	€ 850,00
40 mm	Codice	BA 40 + cod. modello
	Col. base	€ 645,00
	Vern. particolare	€ 675,00
	Bicol-Renolit - Ox	€ 715,00
	Vern. legno	€ 899,00

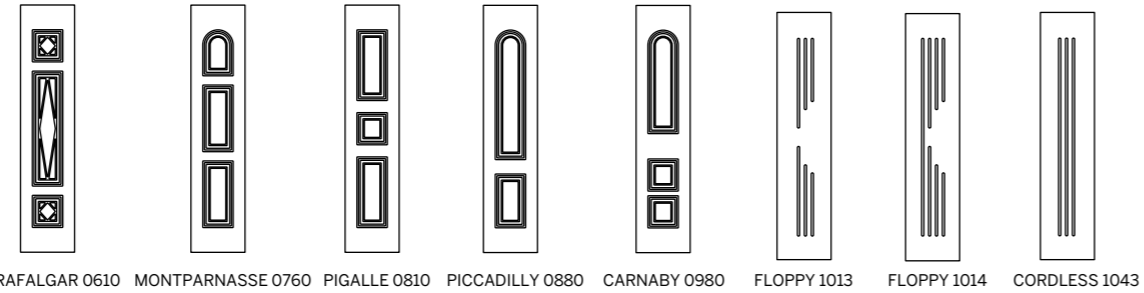

P.O.L.

7 mm	Codice	BB 7 + cod. modello
	Verniciato	€ 360,00
	Vern. legno	€ 525,00
15 mm	Codice	BB 15 + cod. modello
	Verniciato	€ 440,00
	Vern. legno	€ 590,00
22 mm	Codice	BB 22 + cod. modello
	Col. base	€ 475,00
	Vern. particolare	€ 505,00
	Bicol-Renolit - Ox	€ 545,00
	Vern. legno	€ 710,00
31 mm	Codice	BB 31 + cod. modello
	Col. base	€ 535,00
	Vern. particolare	€ 565,00
	Bicol-Renolit - Ox	€ 605,00
	Vern. legno	€ 785,00

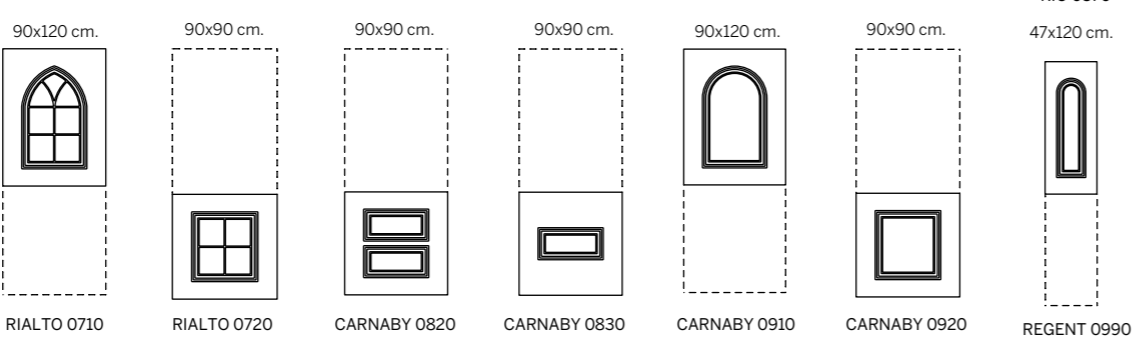
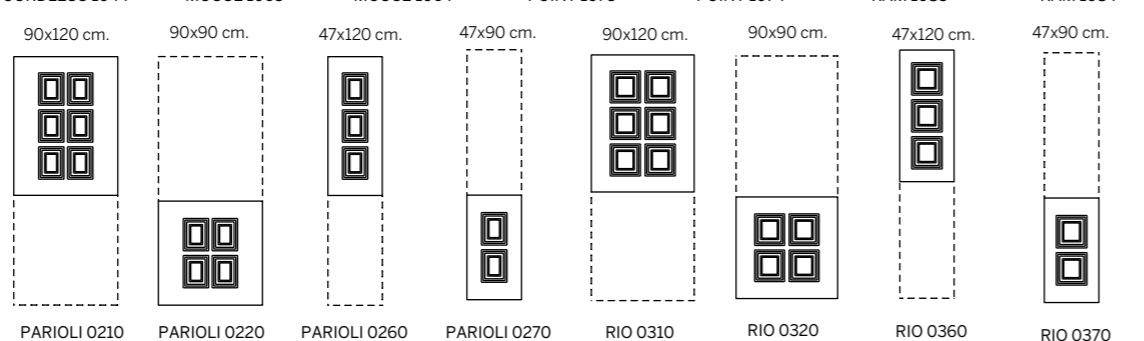
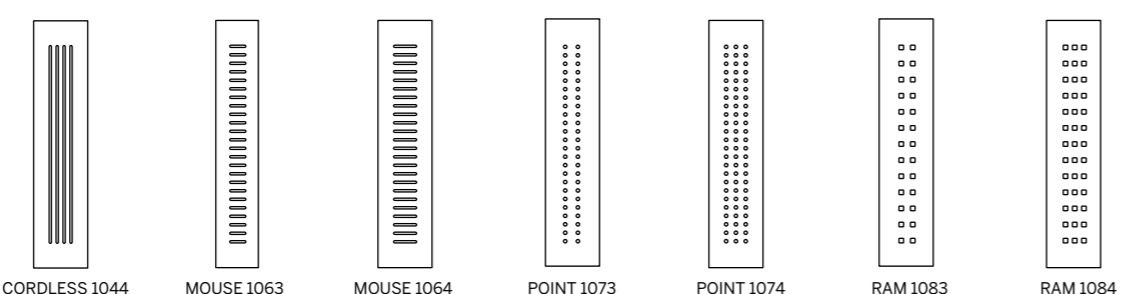

M.D.F.

7 mm	Codice	BM 7 + cod. modello
	Verniciato	€ 240,00
	Vern. legno	€ 330,00
15 mm	Codice	BM 15 + cod. modello
	Verniciato	€ 252,00
	Vern. legno	€ 394,00
22 mm	Codice	BM 22 + cod. modello
	Col. base	€ 252,00
	Vern. particolare	€ 276,00
	Bicol-Renolit - Ox	€ 285,00
	Vern. legno	€ 388,00
31 mm	Codice	BM 31 + cod. modello
	Col. base	€ 312,00
	Vern. particolare	€ 342,00
	Bicol-Renolit - Ox	€ 360,00
	Vern. legno	€ 484,00
42 mm	Codice	BM 42 + cod. modello
	Col. base	€ 394,00
	Vern. particolare	€ 440,00
	Bicol-Renolit - Ox	€ 454,00
	Vern. legno	€ 612,00

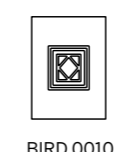

BIRD 0010



LION 0020

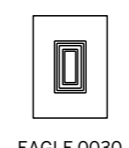

EAGLE 0030

P.I.R.

25 mm	Codice	BP 25 + cod. modello
	Col. base	€ 252,00
	Vern. particolare	€ 276,00
	Bicol-Renolit - Ox	€ 285,00
	Vern. legno	€ 388,00
30 mm	Codice	BP 30 + cod. modello
	Col. base	€ 312,00
	Vern. particolare	€ 342,00
	Bicol-Renolit - Ox	€ 360,00
	Vern. legno	€ 484,00

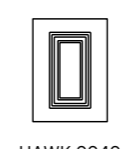

HAWK 0040

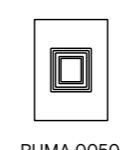

PUMA 0050

H.I. ANIMA FLESSIBILE

26 mm	Codice	BA 26 + cod. modello
	Col. base	€ 300,00
	Vern. particolare	€ 316,00
	Bicol-Renolit - Ox	€ 338,00
	Vern. legno	€ 438,00
30 mm	Codice	BA 30 + cod. modello
	Col. base	€ 310,00
	Vern. particolare	€ 328,00
	Bicol-Renolit - Ox	€ 350,00
	Vern. legno	€ 448,00
35 mm	Codice	BA 35 + cod. modello
	Col. base	€ 330,00
	Vern. particolare	€ 346,00
	Bicol-Renolit - Ox	€ 368,00
	Vern. legno	€ 468,00
40 mm	Codice	BA 40 + cod. modello
	Col. base	€ 354,00
	Vern. particolare	€ 370,00
	Bicol-Renolit - Ox	€ 394,00
	Vern. legno	€ 492,00

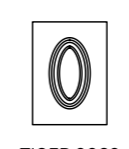

TIGER 0060

P.O.L.

7 mm	Codice	BB 7 + cod. modello
	Verniciato	€ 270,00
	Vern. legno	€ 436,00
15 mm	Codice	BB 15 + cod. modello
	Verniciato	€ 276,00
	Vern. legno	€ 440,00
22 mm	Codice	BB 22 + cod. modello
	Col. base	€ 252,00
	Vern. particolare	€ 276,00
	Bicol-Renolit - Ox	€ 285,00
	Vern. legno	€ 388,00
31 mm	Codice	BB 31 + cod. modello
	Col. base	€ 294,00
	Vern. particolare	€ 310,00
	Bicol-Renolit - Ox	€ 332,00
	Vern. legno	€ 432,00

CARATTERISTICHE E MISURE

PANNELLI STANDARD

Esempio: **ARSENAL 0100**

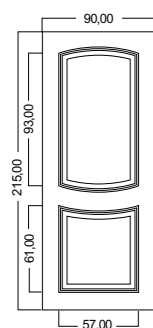

DESCRIZIONE	MISURE	PREZZI
Anta	L. 90 cm x H. 215 cm	prezzo standard
Fuori misura verniciato	L. 100 cm x H. 250 cm	+ 156,00 €/cad.
Fuori misura tinta legno (tutti)	L. 100 cm x H. 220 cm	+ 228,00 €/cad.
Fuori misura tinta legno Uberall	L. 100 cm x H. 250 cm	+ 228,00 €/cad.
Taglio a misura		+ 44,00 €/cad.

NB: fuori misura H 250 cm realizzabile solo con supporto in MDF - PIR - HI.

PANNELLI PER ANTINE

Esempio: **GREENFORD 0110**

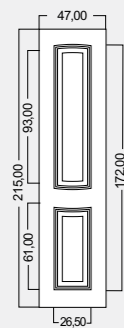

DESCRIZIONE	MISURE	PREZZI
Anta	L. 47 cm x H. 215 cm	prezzo standard
Fuori misura verniciato	L. 49 cm x H. 250 cm	+ 78,00 €/cad.
Fuori misura tinta legno (tutti)	L. 49 cm x H. 220 cm	+ 114,00 €/cad.
Fuori misura tinta legno Uberall	L. 49 cm x H. 250 cm	+ 114,00 €/cad.
Taglio a misura		+ 44,00 €/cad.

NB: fuori misura H 250 cm realizzabile solo con supporto in MDF - PIR - HI; per larghezze oltre 49 cm, vedi prezzo pannello art. 0100.

PANNELLI ART. 0210 - 0310 - 0710 - 0910

Esempio: **RIO 0310**

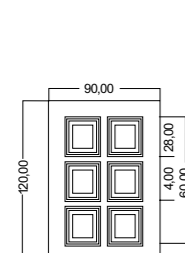

DESCRIZIONE	MISURE	PREZZI
Anta	L. 90 cm x H. 120 cm	prezzo standard
Fuori misura verniciato	L. 100 cm x H. 120 cm	+ 78,00 €/cad.
Fuori misura tinta legno (tutti)	L. 100 cm x H. 120 cm	+ 114,00 €/cad.
Fuori misura tinta legno Uberall	L. 100 cm x H. 120 cm	+ 114,00 €/cad.
Taglio a misura		+ 44,00 €/cad.

NB: per altezza oltre 120 cm, vedi prezzo pannello art. 0100.

SOTTO PERSIANA

Esempio: **LION 0020**

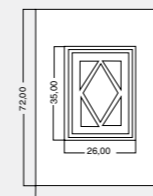

DESCRIZIONE	MISURE	PREZZI
Anta	L. 49 cm x H. 72 cm	prezzo standard
Fuori misura verniciato	L. 49 cm x H. 82 cm	+ 37,00 €/cad.
Fuori misura tinta legno (tutti)	L. 49 cm x H. 82 cm	+ 57,00 €/cad.
Fuori misura tinta legno Uberall	L. 49 cm x H. 82 cm	+ 57,00 €/cad.
Taglio a misura		+ 44,00 €/cad.

NB: per altezza oltre 82 cm e larghezza oltre 49 cm, vedi prezzo pannello art. 0110.

PANNELLI ART. 0260 - 0360 - 0990

Esempio: **RIO 0360**

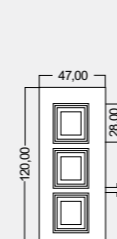

DESCRIZIONE	MISURE	PREZZI
Anta	L. 47 cm x H. 120 cm	prezzo standard
Fuori misura verniciato	L. 49 cm x H. 120 cm	+ 39,00 €/cad.
Fuori misura tinta legno (tutti)	L. 49 cm x H. 120 cm	+ 57,00 €/cad.
Fuori misura tinta legno Uberall	L. 49 cm x H. 120 cm	+ 57,00 €/cad.
Taglio a misura		+ 44,00 €/cad.

NB: per altezza oltre 120 cm, vedi prezzo pannello art.0110; per larghezza oltre 49 cm, vedi prezzo pannello art. 0100.

PANNELLI ART. 0270 - 0370

Esempio: **RIO 0370**

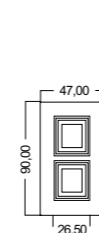

DESCRIZIONE	MISURE	PREZZI
Anta	L. 47 cm x H. 90 cm L. 47 cm x H. 120 cm	prezzo standard
Fuori misura verniciato	L. 49 cm x H. 120 cm	+ 39,00 €/cad.
Fuori misura tinta legno (tutti)	L. 49 cm x H. 120 cm	+ 57,00 €/cad.
Fuori misura tinta legno Uberall	L. 49 cm x H. 120 cm	+ 57,00 €/cad.
Taglio a misura		+ 44,00 €/cad.

NB: per altezza oltre 120 cm, vedi prezzo pannello art. 0110; per larghezza oltre 49 cm, vedi prezzo pannello art. 0100.

PANNELLI ART. 0220 - 0320 - 0720
0820 - 0830 - 0920

Esempio: **RIO 0320**

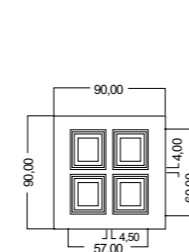

DESCRIZIONE	MISURE	PREZZI
Anta	L. 90 cm x H. 90 cm L. 90 cm x H. 120 cm	prezzo standard
Fuori misura verniciato	L. 100 cm x H. 120 cm	+ 78,00 €/cad.
Fuori misura tinta legno (tutti)	L. 100 cm x H. 120 cm	+ 114,00 €/cad.
Fuori misura tinta legno Uberall	L. 100 cm x H. 120 cm	+ 114,00 €/cad.
Taglio a misura		+ 44,00 €/cad.

NB: per altezza oltre 120 cm, vedi prezzo pannello art. 0100.

PANNELLI PER PORTE BLINDATE

IMPORTANTE: al momento dell'ordine specificare il tipo di bordatura da fare: 3 lati - 4 lati o 3 lati con fresatura inferiore; in caso in cui non dovesse essere specificato verrà fatto con bordatura a 3 lati.

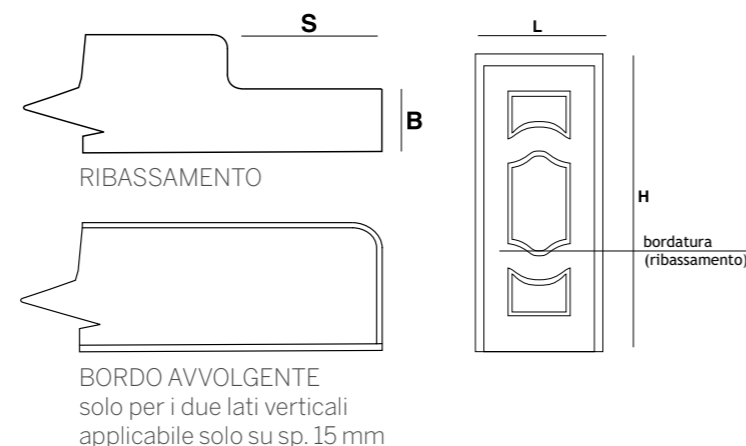

SPESSORE 7 MM

Il pannello con sp. 7 mm presenta un'unica bugna da un solo lato e nella parte interna la lamiera zincata

DIMENSIONI	I pannelli vengono realizzati "su misura" e senza nessun costo aggiuntivo per misure fino a cm 95 x 215		prezzo standard
FUORI MISURA	Verniciato (tutti)	misure max del pannello cm 100 x 250	+ 80,00€/cad.
	Verniciato legno (tutti)	misure max del pannello cm 100 x 220	+ 100,00€/cad.
	Verniciato legno Uberall	misure max del pannello cm 100 x 250	+ 100,00€/cad.
SPECIALI	Verniciato (tutti)	misure max del pannello cm 120 x 248	+ 236,00€/cad.
	Verniciato legno Uberall	misure max del pannello cm 120 x 248	+ 328,00€/cad.
LAVORAZIONI	Il pannello può essere realizzato con bordo ribassato specificando al momento dell'ordine le misure "S" e "B". Ribassamento misura (B): mm 4,5,6.		prezzo standard
	Bordatura (ribassamento) su tre lati o quattro lati - pannello M.D.F.		prezzo standard
	Bordatura (ribassamento) su tre lati o quattro lati - pannello P.O.L.		+ 85,00€/cad.
	Taglio a misura del pannello		compreso
NB: pannello con dimensioni oltre cm 100 x 220 disponibile solo versioni in MDF.			

SPESSORE 15 MM

Il pannello con sp. 15 mm presenta le bugnature da un solo lato e nella parte interna la lamiera zincata

DIMENSIONI	I pannelli vengono realizzati "su misura" e senza nessun costo aggiuntivo per misure fino a cm 95 x 215		prezzo standard
FUORI MISURA	Verniciato (tutti)	misure max del pannello cm 98 x 248	+ 80,00€/cad.
	Verniciato legno (tutti)	misure max del pannello cm 98 x 220	+ 100,00€/cad.
	Verniciato legno Uberall	misure max del pannello cm 98 x 248	+ 100,00€/cad.
SPECIALI	Verniciato (tutti)	misure max del pannello cm 120 x 248	+ 236,00€/cad.
	Verniciato legno Uberall	misure max del pannello cm 120 x 248	+ 328,00€/cad.
LAVORAZIONI	Il pannello può essere realizzato con bordo ribassato specificando al momento dell'ordine le misure "S" e "B". Ribassamento misura (B): mm 4,5,6,7,8,9,10,11,12.		prezzo standard
	Bordatura (ribassamento) su tre lati o quattro lati - pannello M.D.F.		prezzo standard
	Bordatura (ribassamento) su tre lati o quattro lati - pannello P.O.L.		+ 85,00€/cad.
	Bordatura avvolgente su due lati verticali - solo per sp. 15 mm		compreso
	Fresatura sul lato inferiore		a richiesta senza supplemento
Taglio a misura del pannello			compreso
NB: pannello con dimensioni oltre cm 98 x 220 disponibile solo versioni in MDF.			

PANNELLI INTERNI IN LEGNO

Al fine di semplificare la realizzazione di portoncini in legno/alluminio o di porte blindate con l'inserimento di un pannello interno riportante lo stesso motivo del pannello esterno in alluminio, abbiamo previsto:



Esempio finitura: mogano



Esempio finitura: noce



Esempio finitura: noce chiaro



Esempio finitura: laccato avorio

BK15 + ART. MODELLO BUGNALL	Pannello pantografato Essenze Okumè a fibre parallele Spessore 15 mm Finitura grezzo	
	Misure standard del pannello cm 94 x 214	+ 296,00€/cad.
	Fuori misura del pannello cm 110 x 250	+ 296,00€/cad.
BK15 + ART. MODELLO BUGNALL	Pannello pantografato Essenze Okumè a fibre parallele Spessore 15 mm Finitura verniciato: Mogano, Noce scuro, Noce medio, Ciliegio, Rovere, Laccato Bianco	
	Misure standard del pannello cm 94 x 214	+ 568,00€/cad.
	Fuori misura del pannello cm 110 x 250	+ 568,00€/cad.

COPRIFILI

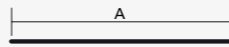
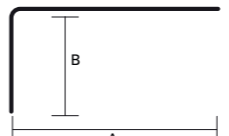
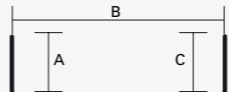
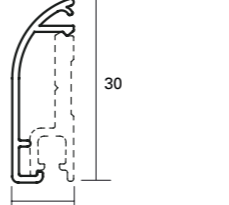
PIATTO IN ALLUMINIO 1,2 MM 	BS 77VS - piatto verniciato altezza 2500 mm. Con larghezza fino a 50 mm	+ 38,00€/cad.
	BS 77UB - piatto Uberall/legno altezza 2500 mm. Con larghezza fino a 50 mm	+ 52,00€/cad.
N.B. maggiorazione di € 6,00 ad ogni incremento di 50 mm allo sviluppo		
PIATTO IN ALLUMINIO 1,2 MM 	BS 78VS - angolare verniciato altezza 2500 mm. Con larghezza fino a 50 mm	+ 54,00€/cad.
	BS 78UB - angolare Uberall/legno altezza 2500 mm. Con larghezza fino a 50 mm	+ 68,00€/cad.
N.B. maggiorazione di € 6,00 ad ogni incremento di 50 mm allo sviluppo		
	BS 79VS - canalino verniciato altezza 2500 mm. Con larghezza fino a 50 mm	+ 56,00€/cad.
	BS 79UB - canalino Uberall/legno altezza 2500 mm. Con larghezza fino a 50 mm.	+ 76,00€/cad.
N.B. maggiorazione di € 7,00 ad ogni incremento di 50 mm allo sviluppo		
	Gocciolatoio L. 1000 mm completo di supporto e tappi laterali	+ 56,00€/cad.
	BS83VS - verniciato	+ 76,00€/cad.
	BS83OX - anodizzato (argento, elettrocolore chiaro, elettrocolore scuro)	+ 82,00€/cad.
	BS83UB - verniciato legno (solo colori Uberall Ponzio)	
NB: per lunghezze fuori misura, contattare i nostri uffici.		

VETRI

1125

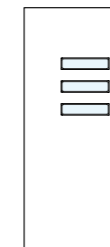

Monaco



	BU09915			BU09916			BU09917		
Finitura	Fuso Sabbiato			Satinato Bianco			Satinato Bronzo		
Spessore	22mm	26mm	32mm	22 mm	26 mm	32 mm	22mm	26mm	32mm
Prezzo*	€ 796,00	836,00	956,00	€ 232,00	272,00	312,00	€ 232,00	272,00	312,00

*Prezzo riferito a n. 3 vetri

1135



Istanbul

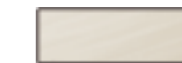

	BU09918			BU09919			BU09920		
Finitura	Fuso Sabbiato			Satinato Bianco			Sabbiato Bronzo		
Spessore	22mm	26mm	32mm	22mm	26mm	32mm	22 mm	26 mm	32 mm
Prezzo*	€ 1.592,00	1.672,00	1.912,00	€ 464,00	544,00	624,00	€ 464,00	544,00	624,00

*Prezzo riferito a n. 5 vetri

1145

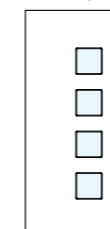

Toronto



	BU09921			BU09922			BU09923		
Finitura	Fuso Sabbiato			Satinato Bianco			Satinato Bronzo		
Spessore	22 mm	26 mm	32 mm	22 mm	26 mm	32 mm	22 mm	26 mm	32 mm
Prezzo*	€ 1.592,00	1.672,00	1.912,00	€ 464,00	544,00	624,00	€ 464,00	544,00	624,00

*Prezzo riferito a n. 4 vetri

VETRI

305

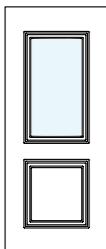

Aston



BU09912

Finitura	Fuso Sabbiato		
Spessore	22mm	26mm	32mm
Prezzo	470,00	494,00	566,00



BU09913

Finitura	Satinato Bianco		
Spessore	22mm	26mm	32mm
Prezzo	230,00	250,00	270,00



BU09914

Finitura	Satinato Bronzo		
Spessore	22mm	26mm	32mm
Prezzo	230,00	250,00	270,00



BU09811

Finitura	Tiffany Eclipse		
Spessore	22mm	26mm	32mm
Prezzo	880,00	924,00	1.012,00



BU09900

Finitura	Tiffany		
Spessore	22mm	26mm	32mm
Prezzo	868,00	956,00	1.042,00



BU09810

Finitura	Tiffany		
Spessore	22mm	26mm	32mm
Prezzo	880,00	924,00	1.012,00



BU09885

Finitura	Tiffany		
Spessore	22mm	26mm	32mm
Prezzo	822,00	906,00	988,00



BU09881

Finitura	Vetro fusione		
Spessore	22mm	26mm	32mm
Prezzo	1.006,00	1.106,00	1.206,00



BU09819

Finitura	Fuso Sabbiato		
Spessore	22mm	26mm	32mm
Prezzo	470,00	494,00	566,00



BU90451

Finitura	Satinato bianco		
Spessore	22mm	26mm	32mm
Prezzo	230,00	250,00	270,00



BU90452

Finitura	Satinato bronzo		
Spessore	22mm	26mm	32mm
Prezzo	230,00	250,00	270,00

105

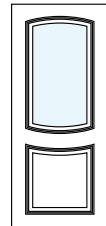

Arsenal

VETRI

315



Aston

115

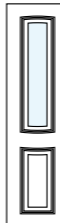

Greenford



BU09829

Finitura	Fuso Sabbiato		
Spessore	22mm	26mm	32mm
Prezzo	416,00	436,00	500,00



BU90455

Finitura	Satinato bianco		
Spessore	22mm	26mm	32mm
Prezzo	160,00	180,00	200,00



BU90456

Finitura	Satinato bronzo		
Spessore	22mm	26mm	32mm
Prezzo	160,00	180,00	200,00



BU09821

Finitura	Tiffany Eclipse		
Spessore	22mm	26mm	32mm
Prezzo	542,00	570,00	624,00



BU09820

Finitura	Tiffany		
Spessore	22mm	26mm	32mm
Prezzo	482,00	570,00	624,00



BU09899

Finitura	Tiffany		
Spessore	22mm	26mm	32mm
Prezzo	502,00	554,00	604,00



BU09886

Finitura	Tiffany		
Spessore	22mm	26mm	32mm
Prezzo	572,00	628,00	686,00



BU09882

Finitura	Vetro fusione		
Spessore	22mm	26mm	32mm
Prezzo	434,00	478,00	522,00

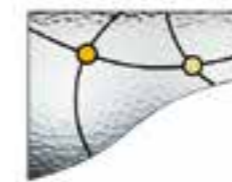

BU09830 sx

Finitura	Tiffany Eclipse		
Spessore	22mm	26mm	32mm
Prezzo	476,00	500,00	548,00

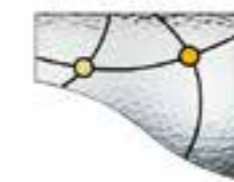

BU09840 dx

Finitura	Tiffany		
Spessore	22mm	26mm	32mm
Prezzo	476,00	500,00	548,00



BU09833 sx

Finitura	Vetro fusione		
Spessore	22mm	26mm	32mm
Prezzo	430,00	452,00	496,00



BU09843 dx

Finitura	Vetro fusione		
Spessore	22mm	26mm	32mm
Prezzo	430,00	452,00	496,00

125/126



Kenton



BU09839 sx

Finitura	Fuso sabbato		
Spessore	22mm	26mm	32mm
Prezzo	454,00	478,00	546,00



BU09849 dx

Finitura	Fuso sabbato		
Spessore	22mm	26mm	32mm
Prezzo	454,00	478,00	546,00



BU90457

Finitura	Satinato bianco		
Spessore	22mm	26mm	32mm
Prezzo	190,00	210,00	230,00



BU90458

Finitura	Satinato bronzo		
Spessore	22mm	26mm	32mm
Prezzo	190,00	210,00	230,00

145



Wembley



BU09851

Finitura	Tiffany		
Spessore	22mm	26mm	32mm
Prezzo	690,00	724,00	794,00



BU09859

Finitura	Fuso sabbato		
Spessore	22mm	26mm	32mm
Prezzo	510,00	534,00	612,00



BU90459

Finitura	Satinato bianco		
Spessore	22mm	26mm	32mm
Prezzo	190,00	210,00	230,00



BU90461

Finitura	Satinato bronzo		
Spessore	22mm	26mm	32mm
Prezzo	190,00	210,00	230,00

VETRI

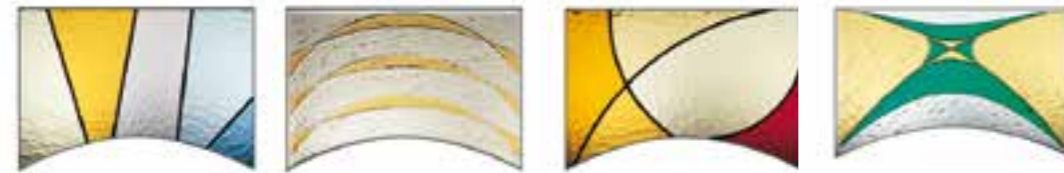

	BU09860			BU09862			BU09861			BU09863		
Finitura	Tiffany			Vetro Fusione			Tiffany Eclipse			Vetro Fusione		
Spessore	22 mm	26 mm	32 mm	22 mm	26 mm	32 mm	22 mm	26 mm	32 mm	22 mm	26 mm	32 mm
Prezzo	€ 486,00	510,00	560,00	€ 482,00	506,00	554,00	€ 480,00	504,00	552,00	€ 478,00	502,00	550,00



	BU09869			BU90464			BU90465		
Finitura	Fuso Sabbiato			Satinato Bianco			Satinato Bronzo		
Spessore	22 mm	26 mm	32 mm	22 mm	26 mm	32 mm	22 mm	26 mm	32 mm
Prezzo	€ 454,00	478,00	546,00	€ 190,00	210,00	230,00	€ 190,00	210,00	230,00



	BU09870			BU09871			BU09874		
Finitura	Tiffany			Tiffany			Tiffany		
Spessore	22 mm	26 mm	32 mm	22 mm	26 mm	32 mm	22 mm	26 mm	32 mm
Prezzo	€ 492,00	516,00	566,00	€ 710,00	746,00	818,00	€ 710,00	746,00	818,00



	BU09879			BU90468			BU90469		
Finitura	Fuso Sabbiato			Satinato Bianco			Satinato Bronzo		
Spessore	22 mm	26 mm	32 mm	22 mm	26 mm	32 mm	22 mm	26 mm	32 mm
Prezzo	€ 450,00	472,00	540,00	€ 190,00	210,00	230,00	€ 190,00	210,00	230,00

0165

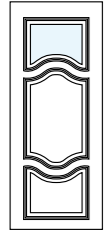

Kennington

0185

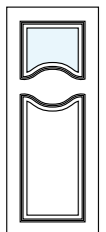

Victoria

VETRI



	BU09706 sx			BU09716 dx			BU09704 sx			BU09714 dx			BU09710 dx		
Finitura	Tiffany			Tiffany			Tiffany			Tiffany			Tiffany		
Spessore	22 mm	26 mm	32 mm	22 mm	26 mm	32 mm	22 mm	26 mm	32 mm	22 mm	26 mm	32 mm	22 mm	26 mm	32 mm
Prezzo	€ 732,00	768,00	842,00	€ 732,00	768,00	842,00	€ 516,00	542,00	620,00	€ 516,00	542,00	620,00	€ 668,00	702,00	770,00



	BU09709 sx			BU09719 dx			BU90473			BU90474		
Finitura	Fuso Sabbiato			Fuso Sabbiato			Satinato Bianco			Satinato Bronzo		
Spessore	22 mm	26 mm	32 mm	22 mm	26 mm	32 mm	22 mm	26 mm	32 mm	22 mm	26 mm	32 mm
Prezzo	€ 526,00	554,00	634,00	€ 526,00	554,00	634,00	€ 190,00	210,00	230,00	€ 190,00	210,00	230,00

0455/0456



Soho



	BU09883			BU09898			BU09897			BU09721			BU09727		
Finitura	Vetro Fusione			Tiffany			Tiffany			Vetro Fusione			Tiffany		
Spessore	22 mm	26 mm	32 mm	22 mm	26 mm	32 mm	22 mm	26 mm	32 mm	22 mm	26 mm	32 mm	22 mm	26 mm	32 mm
Prezzo	€ 914,00	1.006,00	1.098,00	€ 732,00	804,00	878,00	€ 686,00	754,00	822,00	€ 710,00	746,00	818,00	€ 748,00	786,00	860,00

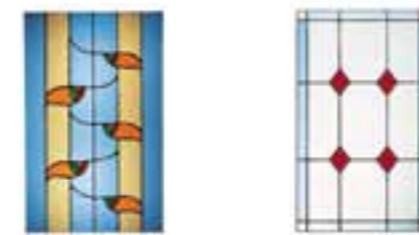

	BU09728			BU09720		
Finitura	Tiffany			Tiffany		
Spessore	22 mm	26 mm	32 mm	22 mm	26 mm	32 mm
Prezzo	€ 692,00	726,00	796,00	€ 688,00	724,00	792,00



	BU09729			BU90475			BU90476		
Finitura	Fuso Sabbiato			Satinato Bianco			Satinato Bronzo		
Spessore	22 mm	26 mm	32 mm	22 mm	26 mm	32 mm	22 mm	26 mm	32 mm
Prezzo	€ 432,00	454,00	518,00	€ 230,00	250,00	270,00	€ 230,00	250,00	270,00

0565

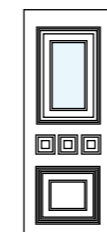

Harlem

VETRI

0585

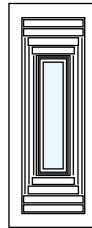

Cascais



BU09733



BU09734



BU09739



BU90479



BU90481

Finitura	Vetro Fusione			Vetro Fusione			Fuso Sabbbiato			Satinato Bianco			Satinato Bronzo		
Spessore	22 mm	26 mm	32 mm	22 mm	26 mm	32 mm	22 mm	26 mm	32 mm	22 mm	26 mm	32 mm	22 mm	26 mm	32 mm
Prezzo	€ 430,00	452,00	516,00	€ 426,00	446,00	510,00	€ 404,00	424,00	484,00	€ 160,00	180,00	200,00	€ 160,00	180,00	200,00

0405

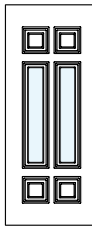

Orlando



BU09880



BU09316



BU09310

Finitura	Vetro Fusione			Tiffany			Tiffany		
Spessore	22 mm	26 mm	32 mm	22 mm	26 mm	32 mm	22 mm	26 mm	32 mm
Prezzo	€ 868,00	956,00	1.042,00	€ 396,00	416,00	458,00	€ 320,00	336,00	368,00

0605

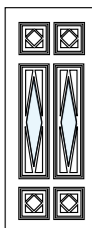

Trafalgar

0615

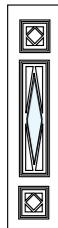

BU09319



BU90482



BU90483

Finitura	Fuso Sabbbiato			Satinato Bianco			Satinato Bronzo		
Spessore	22 mm	26 mm	32 mm	22 mm	26 mm	32 mm	22 mm	26 mm	32 mm
Prezzo	€ 404,00	424,00	484,00	€ 160,00	180,00	200,00	€ 160,00	180,00	200,00

0635



Queens

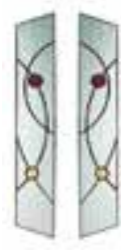

BU09740



BU09743



BU09746

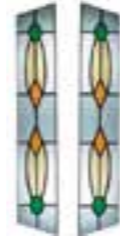

BU09747

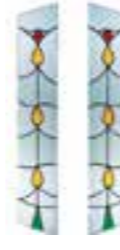

BU09748

Finitura	Tiffany			Vetro Fusione			Tiffany			Tiffany			Tiffany		
Spessore	22 mm	26 mm	32 mm	22 mm	26 mm	32 mm	22 mm	26 mm	32 mm	22 mm	26 mm	32 mm	22 mm	26 mm	32 mm
Prezzo*	€ 764,00	802,00	878,00	€ 588,00	618,00	706,00	€ 494,00	518,00	568,00	€ 346,00	362,00	398,00	€ 428,00	450,00	494,00

*Prezzo riferito alla coppia

VETRI

0635



Queens



BU09749



BU90484



BU90485

Finitura	Fuso Sabbbiato			Satinato Bianco			Satinato Bronzo		
Spessore	22 mm	26 mm	32 mm	22 mm	26 mm	32 mm	22 mm	26 mm	32 mm
Prezzo*	€ 532,00	560,00	640,00	€ 320,00	360,00	400,00	€ 320,00	360,00	400,00

*Prezzo riferito alla coppia



BU09901



BU09516



BU09517

Finitura	Vetro Fusione			Tiffany			Tiffany		
Spessore	22 mm	26 mm	32 mm	22 mm	26 mm	32 mm	22 mm	26 mm	32 mm
Prezzo	€ 778,00	854,00	932,00	€ 442,00	464,00	510,00	€ 442,00	464,00	510,00

0655



Trocadero



BU09519



BU90486



BU90487

Finitura	Fuso Sabbbiato			Satinato Bianco			Satinato Bronzo		
Spessore	22 mm	26 mm	32 mm	22 mm	26 mm	32 mm	22 mm	26 mm	32 mm
Prezzo	€ 398,00	418,00	478,00	€ 116,00	136,00	156,00	€ 116,00	136,00	156,00

0675



Broadway



BU09905



BU09759



BU90491



BU90492

Finitura	Tiffany			Fuso Sabbbiato			Satinato Bianco			Satinato Bronzo		
Spessore	22 mm	26 mm	32 mm	22 mm	26 mm	32 mm	22 mm	26 mm	32 mm	22 mm	26 mm	32 mm
Prezzo	€ 868,00	956,00	1.042,00	€ 398,00	418,00	478,00	€ 116,00	136,00	156,00	€ 116,00	136,00	156,00

VETRI



BU09760

Finitura	Tiffany		
Spessore	22 mm	26 mm	32 mm
Prezzo	€ 898,00	942,00	1.032,00



BU09896

Finitura	Tiffany		
Spessore	22 mm	26 mm	32 mm
Prezzo	€ 914,00	1.006,00	1.098,00



BU09892

Finitura	Tiffany		
Spessore	22 mm	26 mm	32 mm
Prezzo	€ 822,00	906,00	988,00



BU09891

Finitura	Vetro Fusione		
Spessore	22 mm	26 mm	32 mm
Prezzo	€ 868,00	956,00	1.042,00



BU09761

Finitura	Tiffany		
Spessore	22 mm	26 mm	32 mm
Prezzo	€ 926,00	974,00	1.066,00



BU09766

Finitura	Tiffany		
Spessore	22 mm	26 mm	32 mm
Prezzo	€ 758,00	796,00	874,00



BU09769

Finitura	Fuso Sabbiato		
Spessore	22 mm	26 mm	32 mm
Prezzo	€ 526,00	552,00	632,00



BU90495

Finitura	Satinato Bianco		
Spessore	22 mm	26 mm	32 mm
Prezzo	€ 230,00	250,00	270,00



BU90496

Finitura	Satinato Bronzo		
Spessore	22 mm	26 mm	32 mm
Prezzo	€ 230,00	250,00	270,00

0735

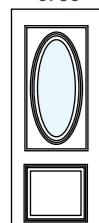

Rivoli



BU09909

Finitura	Tiffany		
Spessore	22 mm	26 mm	32 mm
Prezzo	€ 822,00	906,00	988,00



BU09908

Finitura	Tiffany		
Spessore	22 mm	26 mm	32 mm
Prezzo	€ 1.006,00	1.106,00	1.206,00



BU00961

Finitura	Vetro Fusione		
Spessore	22 mm	26 mm	32 mm
Prezzo	€ 316,00	332,00	364,00



BU00963

Finitura	Vetro Fusione		
Spessore	22 mm	26 mm	32 mm
Prezzo	€ 316,00	332,00	364,00



BU00962

Finitura	Vetro fuso		
Spessore	22 mm	26 mm	32 mm
Prezzo	€ 316,00	332,00	364,00



BU009610

Finitura	Tiffany		
Spessore	22 mm	26 mm	32 mm
Prezzo	€ 706,00	742,00	812,00



BU09618

Finitura	Tiffany		
Spessore	22 mm	26 mm	32 mm
Prezzo	€ 610,00	642,00	702,00



BU09616

Finitura	Tiffany		
Spessore	22 mm	26 mm	32 mm
Prezzo	€ 686,00	720,00	788,00



BU09619

Finitura	Fuso Sabbiato		
Spessore	22 mm	26 mm	32 mm
Prezzo	€ 450,00	472,00	540,00



BU90499

Finitura	Satinato Bianco		
Spessore	22 mm	26 mm	32 mm
Prezzo	€ 190,00	210,00	230,00



BU90501

Finitura	Satinato Bronzo		
Spessore	22 mm	26 mm	32 mm
Prezzo	€ 190,00	210,00	230,00

0755

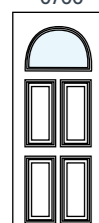

Montparnasse

VETRI



BU09902

Finitura	Vetro Fusione		
Spessore	22 mm	26 mm	32 mm
Prezzo	€ 822,00	906,00	988,00



BU09904

Finitura	Vetro Fusione		
Spessore	22 mm	26 mm	32 mm
Prezzo	€ 868,00	956,00	1.042,00



BU09903

Finitura	Vetro Fusione		
Spessore	22 mm	26 mm	32 mm
Prezzo	€ 778,00	854,00	932,00

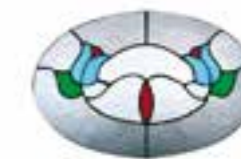

BU09776

Finitura	Tiffany		
Spessore	22 mm	26 mm	32 mm
Prezzo	€ 622,00	652,00	716,00



BU09777

Finitura	Tiffany		
Spessore	22 mm	26 mm	32 mm
Prezzo	€ 698,00	732,00	802,00



BU09778

Finitura	Tiffany		
Spessore	22 mm	26 mm	32 mm
Prezzo	€ 682,00	716,00	784,00



BU09770

Finitura	Tiffany		
Spessore	22 mm	26 mm	32 mm
Prezzo	€ 632,00	664,00	726,00



BU09771

Finitura	Tiffany		
Spessore	22 mm	26 mm	32 mm
Prezzo	€ 662,00	694,00	762,00

0775



Regent



BU09779

Finitura	Fuso Sabbiato		
Spessore	22 mm	26 mm	32 mm
Prezzo	€ 516,00	540,00	620,00



BU90504

Finitura	Satinato Bianco		
Spessore	22 mm	26 mm	32 mm
Prezzo	€ 190,00	210,00	230,00



BU90505

Finitura	Satinato Bronzo		
Spessore	22 mm	26 mm	32 mm
Prezzo	€ 190,00	210,00	230,00

0785



Madison



BU09781

Finitura	Tiffany		
Spessore	22 mm	26 mm	32 mm
Prezzo	€ 468,00	492,00	540,00



BU09782

Finitura	Vetro Fusione		
Spessore	22 mm	26 mm	32 mm
Prezzo	€ 380,00	398,00	458,00



BU09789

Finitura	Fuso Sabbiato		
Spessore	22 mm	26 mm	32 mm
Prezzo	€ 450,00	472,00	540,00



BU90508

Finitura	Satinato Bianco		
Spessore	22 mm	26 mm	32 mm
Prezzo	€ 190,00	210,00	230,00



BU90509

Finitura	Satinato Bronzo		
Spessore	22 mm	26 mm	32 mm
Prezzo	€ 190,00	210,00	230,00

VETRI



BU09893

Finitura	Fuso Sabbiato		
Spessore	22 mm	26 mm	32 mm
Prezzo	€ 686,00	754,00	822,00



BU09890

Finitura	Tiffany		
Spessore	22 mm	26 mm	32 mm
Prezzo	€ 618,00	678,00	740,00



BU09417

Finitura	Tiffany		
Spessore	22 mm	26 mm	32 mm
Prezzo	€ 740,00	778,00	852,00



BU09416

Finitura	Tiffany		
Spessore	22 mm	26 mm	32 mm
Prezzo	€ 694,00	728,00	798,00



BU09420

Finitura	Tiffany		
Spessore	22 mm	26 mm	32 mm
Prezzo	€ 626,00	670,00	734,00

0855

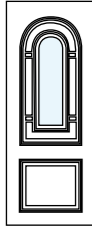

Piccadilly



BU0944

Finitura	Vetro Fusione		
Spessore	22 mm	26 mm	32 mm
Prezzo	€ 622,00	652,00	716,00



BU09419

Finitura	Fuso Sabbiato		
Spessore	22 mm	26 mm	32 mm
Prezzo	€ 438,00	460,00	526,00



BU090511

Finitura	Satinato Bianco		
Spessore	22 mm	26 mm	32 mm
Prezzo	€ 160,00	180,00	200,00



BU090512

Finitura	Satinato Bronzo		
Spessore	22 mm	26 mm	32 mm
Prezzo	€ 160,00	180,00	200,00



BU09110

Finitura	Tiffany		
Spessore	22 mm	26 mm	32 mm
Prezzo	€ 688,00	722,00	792,00



BU09887

Finitura	Tiffany		
Spessore	22 mm	26 mm	32 mm
Prezzo	€ 800,00	880,00	960,00



BU09889

Finitura	Tiffany		
Spessore	22 mm	26 mm	32 mm
Prezzo	€ 686,00	754,00	822,00



BU09884

Finitura	Vetro Fusione		
Spessore	22 mm	26 mm	32 mm
Prezzo	€ 722,00	794,00	866,00



BU090913

Finitura	Vetro Fusione		
Spessore	22 mm	26 mm	32 mm
Prezzo	€ 562,00	588,00	646,00

0955

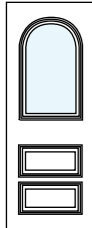

Carnaby



BU09116

Finitura	Tiffany		
Spessore	22 mm	26 mm	32 mm
Prezzo	€ 614,00	646,00	708,00



BU09117

Finitura	Tiffany		
Spessore	22 mm	26 mm	32 mm
Prezzo	€ 692,00	728,00	796,00



BU090921

Finitura	Vetro Fusione		
Spessore	22 mm	26 mm	32 mm
Prezzo	€ 562,00	588,00	646,00



BU090922

Finitura	Vetro Fusione		
Spessore	22 mm	26 mm	32 mm
Prezzo	€ 562,00	588,00	646,00



BU090923

Finitura	Vetro Fusione		
Spessore	22 mm	26 mm	32 mm
Prezzo	€ 562,00	588,00	646,00

0905

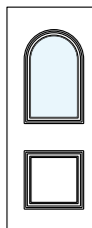

Carnaby



BU09119

Finitura	Fuso Sabbiato		
Spessore	22 mm	26 mm	32 mm
Prezzo	€ 470,00	494,00	566,00



BU090513

Finitura	Satinato Bianco		
Spessore	22 mm	26 mm	32 mm
Prezzo	€ 230,00	250,00	270,00



BU090514

Finitura	Satinato Bronzo		
Spessore	22 mm	26 mm	32 mm
Prezzo	€ 230,00	250,00	270,00

VETRI



BU09910

Finitura	Tiffany		
Spessore	22 mm	26 mm	32 mm
Prezzo*	€ 1.188,00	1.426,00	1.426,00



BU090122

Finitura	Vetro Fusione (giallo)		
Spessore	22 mm	26 mm	32 mm
Prezzo*	€ 736,00	883,00	883,00



BU090124

Finitura	Vetro Fusione (rosso)		
Spessore	22 mm	26 mm	32 mm
Prezzo*	€ 736,00	883,00	883,00

*Prezzo riferito alla coppia



BU090121

Finitura	Vetro Fusione (neutro)		
Spessore	22 mm	26 mm	32 mm
Prezzo*	€ 736,00	883,00	883,00



BU090131

Finitura	Vetro Fusione (neutro)		
Spessore	22 mm	26 mm	32 mm
Prezzo*	€ 736,00	883,00	883,00



BU090134

Finitura	Vetro Fusione (rosso)		
Spessore	22 mm	26 mm	32 mm
Prezzo*	€ 736,00	883,00	883,00



BU090132

Finitura	Vetro Fusione (giallo)		
Spessore	22 mm	26 mm	32 mm
Prezzo*	€ 736,00	883,00	883,00

*Prezzo riferito alla coppia

1015/1016

1025/1026

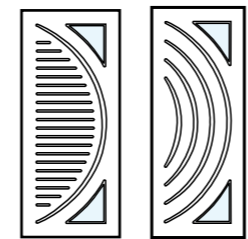

(*)Precox/Net Work

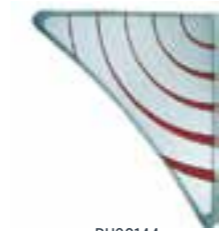

BU090144

Finitura	Vetro Fusione (rosso)		
Spessore	22 mm	26 mm	32 mm
Prezzo*	€ 736,00	883,00	883,00



BU090141

Finitura	Vetro Fusione (neutro)		
Spessore	22 mm	26 mm	32 mm
Prezzo*	€ 736,00	883,00	883,00

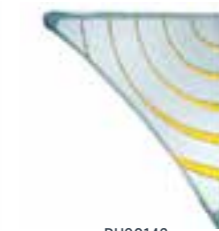

BU090142

Finitura	Vetro Fusione (giallo)		
Spessore	22 mm	26 mm	32 mm
Prezzo*	€ 736,00	883,00	883,00

*Prezzo riferito alla coppia



BU090119

Finitura	Fuso Sabbiato		
Spessore	22 mm	26 mm	32 mm
Prezzo*	€ 736,00	883,00	883,00



BU090147

Finitura	Satinato Bianco		
Spessore	22 mm	26 mm	32 mm
Prezzo*	€ 460,00	552,00	552,00



BU090148

Finitura	Satinato Bronzo		
Spessore	22 mm	26 mm	32 mm
Prezzo*	€ 460,00	552,00	552,00

*Prezzo riferito alla coppia

VETRI



BU90311

Finitura	Vetro Fusione (neutro)		
Spessore	22 mm	26 mm	32 mm
Prezzo	€ 564,00	677,00	677,00



BU90312

Finitura	Vetro Fusione (giallo)		
Spessore	22 mm	26 mm	32 mm
Prezzo	€ 564,00	677,00	677,00



BU90314

Finitura	Vetro Fusione (rosso)		
Spessore	22 mm	26 mm	32 mm
Prezzo	€ 564,00	677,00	677,00



BU09895

Finitura	Tiffany		
Spessore	22 mm	26 mm	32 mm
Prezzo	€ 1.142,00	1.370,00	1.370,00



BU90321

Finitura	Vetro Fusione (neutro)		
Spessore	22 mm	26 mm	32 mm
Prezzo	€ 564,00	677,00	677,00



BU90322

Finitura	Vetro Fusione (giallo)		
Spessore	22 mm	26 mm	32 mm
Prezzo	€ 564,00	677,00	677,00



BU90324

Finitura	Vetro Fusione (rosso)		
Spessore	22 mm	26 mm	32 mm
Prezzo	€ 564,00	677,00	677,00



BU90331

Finitura	Vetro Fusione (neutro)		
Spessore	22 mm	26 mm	32 mm
Prezzo	€ 564,00	677,00	677,00



BU90332

Finitura	Vetro Fusione (giallo)		
Spessore	22 mm	26 mm	32 mm
Prezzo	€ 564,00	677,00	677,00



BU90334

Finitura	Vetro Fusione (rosso)		
Spessore	22 mm	26 mm	32 mm
Prezzo	€ 564,00	677,00	677,00



BU90341

Finitura	Vetro Fusione (neutro)		
Spessore	22 mm	26 mm	32 mm
Prezzo	€ 564,00	677,00	677,00



BU90342

Finitura	Vetro Fusione (giallo)		
Spessore	22 mm	26 mm	32 mm
Prezzo	€ 564,00	677,00	677,00



BU90344

Finitura	Vetro Fusione (rosso)		
Spessore	22 mm	26 mm	32 mm
Prezzo	€ 564,00	677,00	677,00



BU90319

Finitura	Fuso Sabbiato		
Spessore	22 mm	26 mm	32 mm
Prezzo	€ 342,00	410,00	410,00



BU90347

Finitura	Satinato Bianco		
Spessore	22 mm	26 mm	32 mm
Prezzo	€ 270,00	324,00	324,00



BU90348

Finitura	Satinato Bronzo		
Spessore	22 mm	26 mm	32 mm
Prezzo	€ 270,00	324,00	324,00

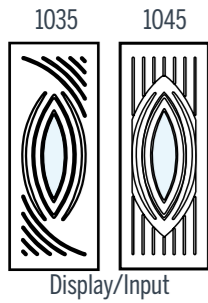

Display/Input

VETRI



BU09907

Finitura	Tiffany		
Spessore	22 mm	26 mm	32 mm
Prezzo	€ 778,00	934,00	934,00



BU90411

Finitura	Vetro Fusione (neutro)		
Spessore	22 mm	26 mm	32 mm
Prezzo	€ 492,00	590,00	590,00



BU90412

Finitura	Vetro Fusione (giallo)		
Spessore	22 mm	26 mm	32 mm
Prezzo	€ 492,00	590,00	590,00



BU90414

Finitura	Vetro Fusione (rosso)		
Spessore	22 mm	26 mm	32 mm
Prezzo	€ 492,00	590,00	590,00



BU90421

Finitura	Vetro Fusione (neutro)		
Spessore	22 mm	26 mm	32 mm
Prezzo	€ 492,00	590,00	590,00



BU90422

Finitura	Vetro Fusione (giallo)		
Spessore	22 mm	26 mm	32 mm
Prezzo	€ 492,00	590,00	590,00



BU90424

Finitura	Vetro Fusione (rosso)		
Spessore	22 mm	26 mm	32 mm
Prezzo	€ 492,00	590,00	590,00



BU90431

Finitura	Vetro Fusione (neutro)		
Spessore	22 mm	26 mm	32 mm
Prezzo	€ 492,00	590,00	590,00



BU90432

Finitura	Vetro Fusione (giallo)		
Spessore	22 mm	26 mm	32 mm
Prezzo	€ 492,00	590,00	590,00



BU90434

Finitura	Vetro Fusione (rosso)		
Spessore	22 mm	26 mm	32 mm
Prezzo	€ 492,00	590,00	590,00



BU90441

Finitura	Vetro Fusione (neutro)		
Spessore	22 mm	26 mm	32 mm
Prezzo	€ 492,00	590,00	590,00



BU90442

Finitura	Vetro Fusione (giallo)		
Spessore	22 mm	26 mm	32 mm
Prezzo	€ 492,00	590,00	590,00



BU90444

Finitura	Vetro Fusione (rosso)		
Spessore	22 mm	26 mm	32 mm
Prezzo	€ 492,00	590,00	590,00



BU90419

Finitura	Fuso Sabbiato		
Spessore	22 mm	26 mm	32 mm
Prezzo	€ 504,00	605,00	605,00



BU90447

Finitura	Satinato Bianco		
Spessore	22 mm	26 mm	32 mm
Prezzo	€ 230,00	276,00	276,00



BU90448

Finitura	Satinato Bronzo		
Spessore	22 mm	26 mm	32 mm
Prezzo	€ 230,00	276,00	276,00



Modem

T.O.R. - Titanium Over Resistant

Consiste nell'applicare uno strato protettivo al titanio, attraverso nebulizzazione di ioni. Questa protezione permette all'ottone di evitare qualsiasi processo di OSSIDAZIONE. Infatti, il rivestimento T.O.R. GARANTISCE PER 30 ANNI la brillantezza della superficie, è contro l'usura, gli attacchi atmosferici e i reagenti chimici.

OROPLUS - Trattamento di protezione GARANTITO 10 ANNI





















La garanzia assoluta d'impiego di materiali di primissima qualità e l'eccellenza di moderni sistemi di produzione e sofisticati processi di trattamento delle superfici, consentono di garantire per 10 anni la finitura OROPLUS dei nostri prodotti.

ROCOCÒ - Verniciatura a forno by Ponzio

Consiste nell'applicare prima un primer alla maniglia in ottone, poi il manufatto viene seccato in forno ad una temperatura di 180°. Dopo il raffreddamento si procede con una meticolosa levigatura sulle superfici; questo processo garantisce un'eccellente morbidezza tattile al prodotto. Successivamente le maniglie vengono DEPOLVERATE e RIFINITE con due mani di vernice colorata e cotte in forno, sempre a 180°. Tutto questo lunghissimo procedimento garantisce una resistenza all'usura pari a quella della vernice metallizzata delle autovetture e, al tempo stesso, valorizza i dettagli e il disegno ROCOCÒ del maniglione/battente.

- ACCIAIO INOX - ACCIAIO INOX AISI 316 - ACCIAIO INX AISI 316L
- OTTONE - OTTONE ANTICO
- CROMO SATINATO
- STAROX
- NEROMAT

ACCESSORI

				
	Quadro attacco fisso	Quadro attacco girevole	Quadro attacco girevole	Kit attacco non passante per battenti
Finitura	BU01	BU02	BU03	BU05
Codice	BU01	BU02	BU03	BU05
Prezzo	€ 8,00	€ 11,00	€ 7,00	€ 14,00
				
	Kit attacco non passante per battenti ridotto	Kit attacco non pass. per maniglioni	Kit attacco non pass. solo per BU322 e BU327	Kit attacco non pass. per maniglioni ridotto
Finitura	BU05R	BU06	BU06R	BU07R
Codice	BU05R	BU06	BU06R	BU07R
Prezzo	€ 11,00	€ 24,00	€ 20,00	€ 18,00
				
	Kit girevole per pomoli BU1362/BU1364/BU1371/BU1374	Maniglione Imperatore	Bocchetta x serratura chiave sagomata	Bocchetta x serratura chiave sagomata
Finitura	BU09	Bronzo sfumato	T.O.R.	Cromosat
Codice	BU09	BU015	BU032	BU034
Prezzo	€ 15,00	€ 121,00	€ 16,00	€ 15,00
				
	Bocchetta x serratura chiave sagomata	Bocchetta x serratura chiave sagomata	Bocchetta x serratura chiave sagomata	Bocchetta x serratura chiave sagomata
Finitura	Neromat	Ottone antico	Patinet Steel	Acciaio
Codice	BU035	BU036	BU037	BU038
Prezzo	€ 13,00	€ 14,00	€ 14,00	€ 14,00
				
	Bocchetta x serratura chiave sagomata	Bocchetta "defender"	Bocchetta "defender"	Bocchetta "defender"
Finitura	STAROX	Acciaio AISI 316L neromat	Acciaio AISI 316L	Oro lucido
Codice	BU039	BU065	BU068	BU072
Prezzo	€ 14,00	€ 13,00	€ 15,00	€ 84,00

ACCESSORI



Bocchetta "defender"
Cromosat
BU074
€ 86,00

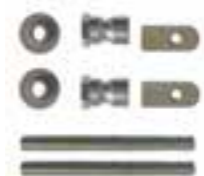

Fissaggio per Maniglione
acciaio inox
BU075
€ 14,00



Fissaggio per Maniglione
acciaio inox
BU076
€ 11,00

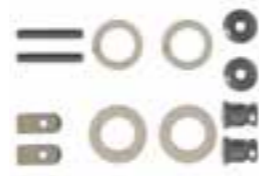

Fissaggio sing. per Maniglione
BU3648
BU077
€ 11,00



Fissaggio doppio x Maniglione
BU3648
BU078
€ 9,00



Fissaggio sing. x Maniglione nylon
BU3698
BU079
€ 11,00



Pomolo tondo
Oro
BU198
€ 64,00



Dado cieco filett. 6MA
T.O.R.
BU241
€ 5,00



Dado cieco filett. 8MA
T.O.R.
BU241/8
€ 5,00



Dado cieco filett. 6MA
Cromosat
BU244
€ 7,00



Dado cieco filett. 8MA
Cromosat
BU244/8
€ 7,00



Dado cieco filett. 6MA
Ottone ant.
BU246
€ 5,00



Dado cieco filett. 8MA
Ottone ant.
BU246/8
€ 5,00



Dado cieco filett. 6MA
Patinet steel
BU247
€ 7,00



Dado cieco filett. 8MA
Patinet steel
BU247/8
€ 7,00



Battente Leone
T.O.R.
BU252
€ 209,00



Battente anello
T.O.R.
BU302
€ 223,00



Battente anello
Ottone antico
BU306
€ 154,00



Maniglione Plutarco
T.O.R.
BU312
€ 183,00



Maniglione Euclide
T.O.R.
BU322
€ 282,00

ACCESSORI



Maniglione Euclide
Patinet Steel
BU327
€ 231,00



Maniglione curvo Archimede
T.O.R.
BU332
€ 222,00



Maniglione Archimede
Patinet Steel
BU337
€ 174,00



Maniglione Socrate
T.O.R.
BU342
€ 310,00



Maniglione Socrate
Cromo sat.
BU344
€ 264,00



Maniglione Cesare
T.O.R.
BU352
€ 216,00



Maniglione Cesare
Ottone antico
BU356
€ 145,00



Maniglione Augusto
T.O.R.
BU362
€ 444,00



Maniglione Aristotele
T.O.R.
BU372
€ 341,00



Maniglione curvo Diocleziano
T.O.R.
BU382
€ 213,00



Maniglione curvo Platone
T.O.R.
BU392
€ 211,00



Maniglione Seneca
T.O.R.
BU402
€ 260,00



Pomolo Giglio
T.O.R.
BU412
€ 148,00



Pomolo maniglia Megara
T.O.R.
BU422
€ 113,00



Maniglione diritto Archimede
T.O.R.
BU432
€ 218,00



Maniglione diritto Diocleziano
T.O.R.
BU482
€ 213,00



Maniglione diritto Platone
T.O.R.
BU492
€ 211,00



Doppio pomolo Ovidio
T.O.R.
BU552
€ 196,00



Battente Fagotto
T.O.R.
BU662
€ 251,00



Battente Fagotto
Patinet Steel
BU667
€ 200,00

ACCESSORI



Battente circolare Arpa
T.O.R.
BU672
€ 306,00



Battente Flauto
T.O.R.
BU682
€ 267,00



Battente Oboe
T.O.R.
BU692
€ 245,00



Battente Viola
T.O.R.
BU712
€ 271,00



Battente Violoncello
T.O.R.
BU722
€ 257,00



Battente Violoncello
Patinet Steel
BU727
€ 209,00



Battente Clavicembalo
T.O.R.
BU732
€ 277,00



Battente Triangolo
T.O.R.
BU742
€ 271,00



Battente Triangolo
Cromo sat.
BU744
€ 258,00



Doppia maniglia "Sara"
T.O.R.
BU882
€ 137,00



Spioncino "Super Mario"
Ottone
BU883
€ 7,00



Spioncino
Nickel cromato
BU894
€ 9,00



Maniglione Luna
T.O.R.
BU1042
€ 205,00



Maniglione Luna
Cromo sat.
BU1044
€ 158,00



Maniglione Luna
Neromat
BU1045
€ 134,00



Maniglione Venere
T.O.R.
BU1062
€ 189,00



Maniglione Venere
Cromosat
BU1064
€ 149,00



Pomolo maniglia Marte
T.O.R.
BU1322
€ 84,00



Pomolo maniglia Marte
Cromo sat.
BU1324
€ 84,00



Pomolo maniglia Marte
STAROX
BU1329
€ 62,00

ACCESSORI



Pomolo
Acciaio inox AISI 316
BU1354
€ 66,00



Pomolo Saturno "fisso"
T.O.R.
BU1362
€ 101,00



Pomolo Saturno
Cromo sat.
BU1364
€ 74,00



Pomolo
Acciaio inox AISI 316
BU1394
€ 73,00



Coppia borchie
T.O.R.
BU1412
€ 88,00



Coppia borchie
Cromo sat.
BU1414
€ 82,00



Coppia borchie
Neromat
BU1415
€ 64,00



Maniglia
Acciaio inox AISI 316
BU1744
€ 33,00



Maniglia
Acciaio inox AISI 316
BU1754
€ 33,00



Maniglia
Acciaio inox AISI 316
BU1764
€ 102,00



Maniglia
Acciaio inox AISI 316
BU1774
€ 84,00



Maniglione Flesso
Oro plus
BU2051
€ 154,00



Maniglione Flesso
T.O.R.
BU2052
€ 227,00



Maniglione Flesso
Cromo sat.
BU2054
€ 166,00



Maniglione Flesso
Neromat
BU2055
€ 132,00



Kit rosette
Oro plus
BU2061
€ 40,00



Kit rosette
T.O.R.
BU2062
€ 65,00



Kit rosette
Cromo sat.
BU2064
€ 46,00



Kit maniglia
Neromat
BU2065
€ 40,00



Battente
T.O.R.
BU2161
€ 172,00

ACCESSORI



Battente

Cromo sat.

BU2164

€ 139,00



Maniglia EDO con bocch.

Cromo sat.

BU2204

€ 128,00



Maniglione Nice

Cromo sat.

BU2304

€ 197,00



Maniglione Zen

Cromo sat.

BU2364

€ 305,00



Kit non passante

BU2401

€ 32,00



Kit passante Oro plus

BU2421

€ 32,00



Kit passante Cromo sat.

BU2424

€ 32,00



Kit passante Neromat

BU2425

€ 32,00



Kit doppio attacco

BU2441

€ 32,00



Kit attacco passante T.O.R.

BU2442

€ 40,00



Rosetta Nero

Acciaio inox AISI 316L (nero)

BU2495

€ 29,00



Rosetta

Acciaio inox AISI 316L

BU2498

€ 31,00



Rosetta Bianca

Acciaio inox AISI 316L (bianco)

BU249811

€ 29,00



Rosetta nero

Acciaio inox AISI 316L (nero)

BU2505

€ 29,00



Rosetta

Acciaio inox AISI 316L

BU2508

€ 31,00



Maniglione Cool 200

Acciaio inox

BU3328

€ 310,00



Maniglione Cool 400

Acciaio inox

BU3348

€ 444,00



Maniglione Cool 800

Acciaio inox

BU3388

€ 621,00



Maniglione Rain 320

Acciaio inox

BU3438

€ 306,00



Maniglione Rain 400

Acciaio inox

BU3468

€ 398,00

ACCESSORI



Maniglione Warm 250 T.O.R.

T.O.R.

BU3522

€ 399,00



Maniglione Warm 250 Neromat

Neromat

BU3525

€ 247,00



Maniglione Warm 250 Starox

Starox

BU3529

€ 295,00



Maniglione Warm 400 T.O.R.

T.O.R.

BU3542

€ 559,00



Maniglione Warm 400 Neromat

Neromat

BU3545

€ 341,00



Maniglione Warm 400 Starox

Starox

BU3549

€ 411,00



Maniglione Birichino Acciaio inox AISI 316L (nero)

Acciaio inox AISI 316L (nero)

BU3575

€ 302,00



Maniglione Birichino Acciaio inox AISI 316L

Acciaio inox AISI 316L

BU3578

€ 315,00



Maniglione Puntatore Acciaio inox AISI 316L (nero)

Acciaio inox AISI 316L (nero)

BU3585

€ 260,00



Maniglione Puntatore Acciaio inox AISI 316L

Acciaio inox AISI 316L

BU3588

€ 278,00



Maniglione Puntatore Acciaio inox AISI 316L (bianco)

Acciaio inox AISI 316L (bianco)

BU358811

€ 356,00



Maniglione Twins Acciaio inox AISI 316L (nero)

Acciaio inox AISI 316L (nero)

BU3595SX

€ 240,00



Maniglione Twins Acciaio inox AISI 316L (nero)

Acciaio inox AISI 316L (nero)

BU3595DX

€ 240,00



Maniglione Twins Acciaio inox AISI 316L

Acciaio inox AISI 316L

BU3598SX

€ 251,00



Maniglione Twins Acciaio inox AISI 316L

Acciaio inox AISI 316L

BU3598DX

€ 251,00



Maniglione Fashion Acciaio inox AISI 316L (nero)

Acciaio inox AISI 316L (nero)

BU3605

€ 280,00



Maniglione Fashion Acciaio inox AISI 316L

Acciaio inox AISI 316L

BU3608

€ 300,00



Maniglione Snow 200 T.O.R.

T.O.R.

BU3622

€ 523,00



Maniglione Snow 200 Neromat

Neromat

BU3625

€ 319,00



Maniglione Snow 200 Starox

Starox

BU3629

€ 388,00

ACCESSORI

			
Maniglione Snow 300 T.O.R.	Maniglione Snow 300 Neromat	Maniglione Snow 300 Starox	Maniglione Trendy Acciaio inox AISI 316L
Finitura Codice Prezzo	Finitura Codice Prezzo	Finitura Codice Prezzo	Finitura Codice Prezzo
BU3632 € 585,00	BU3635 € 363,00	BU3639 € 435,00	BU3648 € 135,00
			
Maniglione Sfrenato Acciaio inox AISI 316L	Maniglione Vip Acciaio inox AISI 316L	Maniglione Magnetic Acciaio inox AISI 316L	Maniglione Smile Acciaio inox AISI 316L
Finitura Codice Prezzo	Finitura Codice Prezzo	Finitura Codice Prezzo	Finitura Codice Prezzo
BU3658 € 95,00	BU3668 € 93,00	BU3678 € 211,00	BU3688 € 138,00
			
Maniglione Luxury Acciaio inox AISI 316L	Maniglione Mohicano Acciaio inox AISI 316L	Maniglione Hot 250 T.O.R.	Maniglione Hot 250 Neromat
Finitura Codice Prezzo	Finitura Codice Prezzo	Finitura Codice Prezzo	Finitura Codice Prezzo
BU3738 € 329,00	BU3748 € 231,00	BU3822 € 416,00	BU3825 € 253,00
			
Maniglione Hot 250 Starox	Maniglione Cold 250 T.O.R.	Maniglione Cold 250 Neromat	Maniglione Cold 250 Starox
Finitura Codice Prezzo	Finitura Codice Prezzo	Finitura Codice Prezzo	Finitura Codice Prezzo
BU3829 € 310,00	BU3922 € 405,00	BU3925 € 249,00	BU3929 € 300,00
			
Maniglione Jack Cromo sat.	Maniglione Jack Neromat	Maniglione Router Cromo sat.	Maniglione Router Neromat
Finitura Codice Prezzo	Finitura Codice Prezzo	Finitura Codice Prezzo	Finitura Codice Prezzo
BU4514 € 422,00	BU4515 € 345,00	BU4524 € 609,00	BU4525 € 493,00

ACCESSORI

			
Maniglione Media Cromo sat.	Maniglione Media Neromat	Battente Browser Cromo sat.	Battente Browser Neromat
Finitura Codice Prezzo	Finitura Codice Prezzo	Finitura Codice Prezzo	Finitura Codice Prezzo
BU4614 € 440,00	BU4615 € 356,00	BU4624 dx € 597,00	BU4625 dx € 480,00
			
Battente Switch Cromo sat.	Battente Switch Neromat	Battente Hardware Cromo sat.	Battente Hardware Neromat
Finitura Codice Prezzo	Finitura Codice Prezzo	Finitura Codice Prezzo	Finitura Codice Prezzo
BU4634 dx € 565,00	BU4635 dx € 457,00	BU4644 sx € 565,00	BU4645 sx € 457,00
			
Battente Compact Cromo sat.	Battente Compact Neromat	Pomolo fisso T.O.R.	Pomolo fisso Neromat
Finitura Codice Prezzo	Finitura Codice Prezzo	Finitura Codice Prezzo	Finitura Codice Prezzo
BU4654 sx € 596,00	BU4655 sx € 480,00	BU4712 € 81,00	BU4715 € 49,00
			
Pomolo fisso Starox	Maniglione Default Cromosat	Maniglione Default Neromat	Battente Connect Cromo sat.
Finitura Codice Prezzo	Finitura Codice Prezzo	Finitura Codice Prezzo	Finitura Codice Prezzo
BU4719 € 57,00	BU4814 € 591,00	BU4815 € 475,00	BU4824 € 838,00
			
Battente Connect Neromat	Battente Cromo sat.	Pomolo fisso T.O.R.	Pomolo fisso Cromo sat.
Finitura Codice Prezzo	Finitura Codice Prezzo	Finitura Codice Prezzo	Finitura Codice Prezzo
BU4825 € 680,00	BU5019 € 207,00	BU5022 € 209,00	BU5029 € 181,00

ACCESSORI



Battente

Starox

BU6629

€ 179,00



Maniglia River 120 mm con rosetta

T.O.R.

BU8052

€ 152,00



Maniglia Prestige 135 mm con rosetta

T.O.R.

BU8252

€ 205,00



Maniglione Prestige

T.O.R.

BU8302

€ 376,00



Maniglia Gladys con rosetta ovale

T.O.R.

BU8352

€ 165,00



Maniglia Gladys

T.O.R.

BU8402

€ 317,00



Maniglia Louise

Oro lucido

BU8602

€ 77,00



Maniglia Louise

Cromo sat.

BU8604

€ 77,00



Maniglia Thelma

Ottone

BU8702

€ 77,00



Maniglia Thelma

Cromo sat.

BU8704

€ 77,00



Maniglia doppia

Cromo sat.

BU8824

€ 110,00



Maniglia doppia

Neromat

BU8825

€ 71,00

ACCESSORI



Maniglia doppia Sara

Starox

BU8829

€ 88,00



Battente Anello

Bianco lucido

BU30211

€ 233,00



Battente Anello

Nero lucido

BU30212

€ 233,00



Maniglione Cesare

Bianco lucido

BU35211

€ 227,00



Maniglione Cesare

Nero lucido

BU35212

€ 227,00



Maniglione Roccò Luna con Rosetta

Bianco lucido

BU104211

€ 253,00



Maniglione Luna con Rosetta

Nero lucido

BU104212

€ 253,00



Maniglione Media

Bianco lucido

BU461411

€ 462,00



Maniglione Media

Nero lucido

BU461412

€ 462,00

Finitura

Codice

Prezzo

Finitura

Codice

Prezzo

